



USER MANUAL Petrol Back Pack Blower MANUEL DE L'UTILISATEUR Souffleur à essence en sac à dos HANDLEIDING Rugblazer op benzine

**SAFETY OPERATION MAINTENANCE
SECURITE FONCTIONNEMENT ENTRETIEN
VEILIGHEID BEDIENING ONDERHOUD**



WARNING • PLEASE READ

For your own safety please read this manual before attempting to operate your new unit. Failure to follow instructions can result in serious personal injury. Spend a few moments to familiarize yourself with your blower before each use.

ATTENTION – LISEZ SVP

Pour votre propre sécurité, veuillez lire attentivement ce manuel avant de tenter de faire fonctionner votre nouvel appareil. Le non-respect des instructions peut entraîner des accidents graves. Prenez quelques instants pour vous familiariser avec le souffleur avant chaque utilisation.

WAARSCHUWING – AANDACHTIG LEZEN

In het belang van uw veiligheid is het noodzakelijk dat u de handleiding leest voordat u met uw nieuw apparaat aan de slag gaat. Het niet opvolgen van de instructies kan ernstige letsels veroorzaken. Neem voldoende tijd om uzelf vertrouwd te maken met de bladblazer voordat u hem daadwerkelijk gebruikt.

Meaning of symbols marked on the product

	Read the user manual before using the machine.		Warning! Danger.
	Wear safety goggles to protect your eyes; Wear ear protector to protect against noise.		Primer bulb.
	Keep bystanders away.		The engine continues to rotate after the unit is switched off.
	Never work while people, especially children or pets are nearby.		Acoustic power level LWA accordance with directive 2000/14/EC
	Warning! Hot surface.		

• WHAT TO DO READ YOUR USER MANUAL AND ALL SUPPLEMENTS (IF ANY ENCLOSED) THOROUGHLY BEFORE OPERATING YOUR UNIT.

- WEAR CLOSE FITTING, TOUGH WORK CLOTHING that will provide protection, such as long slacks or trousers, safety work shoes, heavy duty work gloves, hard hat, a safety face shield, or safety glasses for eye protection and a good grade of ear plugs or other sound barriers for hearing protection.
- REFUEL IN A SAFE PLACE. Open fuel cap slowly to release any pressure which may have formed in fuel tank. Always wipe unit of fuel or oil spills before starting. To prevent a fire hazard, move at least 10 feet (3 meters) from fueling area before starting.
- TURN UNIT OFF before setting it down, and also before installing or removing attachments.
- KEEP ALL SCREWS AND FASTENERS TIGHT and the unit in good operating condition. Never operate this equipment if it is improperly adjusted or not completely and securely assembled.
- KEEP HANDLES DRY, clean and free of fuel mixture.
- STORE EQUIPMENT AWAY FROM POSSIBLE IGNITION SOURCES, such as gas-powered water heaters, clothes dryers, or oil-fired furnaces, portable heaters, etc.
- ALWAYS KEEP the engine free of debris build-up.
- OPERATION OF EQUIPMENT should always be restricted to mature and properly instructed individuals.
- ALL PERSONS WITH RESPIRATORY PROBLEMS and persons operating blower in very dusty environments, should wear a dust particle mask at all times. Paper dust masks are available at most paint and hardware stores.
- Operate the machine only at reasonable hours- not early in the morning or late at night when people might be disturbed. Comply with times listed in local ordinances.
- Operate the machine at the lowest possible engine speed to do the job.
- Use rakes and brooms to loosen debris before blowing.
- In dusty conditions, slightly dampen surfaces.
- Use the full blower nozzle extension so the air stream can work close to the ground.
- Watch out for children, pets, open windows etc. and blow debris safety away.

• WHAT NOT TO DO



WARNING: DO NOT USE ANY OTHER FUEL than that recommended in your manual. Always follow instructions in the Fuel and Lubrication section of this manual. Never use petrol unless it is properly mixed with 2-cycle engine lubricant. Permanent damage to engine will result, voiding manufacturer's warranty.

- DO NOT SMOKE while refueling or operating equipment.
- DO NOT OPERATE UNIT WITHOUT A MUFFLER and properly installed muffler shield.
- DO NOT TOUCH or let your hands or body come in contact with a hot muffler or spark plug wire.
- DUE TO THE DANGER of exhaust fumes, never operate blower in a confined or poorly ventilated area.
- NEVER POINT BLOWER in the direction of people, animals, buildings, automobiles, or windows, etc.
- DO NOT operate unit without inlet cover installed to prevent contact with impeller.
- DO NOT set a hot engine down where flammable material is present.
- DO NOT OPERATE UNIT FOR PROLONGED PERIODS. Rest periodically.



WARNING: DO NOT ADD, REMOVE OR ALTER ANY COMPONENTS OF THIS PRODUCT. Doing so could cause personal injury and/or damage the unit voiding the manufacturer's warranty.

- DO NOT OPERATE UNIT WHILE UNDER THE INFLUENCE OF ALCOHOL OR DRUGS.
- DO NOT operate your unit near or around flammable liquids or gases whether in or out of doors. An explosion and/or fire may result.
- DO NOT WEAR loose clothing, scarfs, neck chains, unconfined long hair, and the like. Doing so could cause injury associated with objects being drawn into the rotating parts.
- DO NOT refuel a running engine or an engine that is hot.
- Never allow children to operate the appliance.

GENERAL IDENTIFICATION

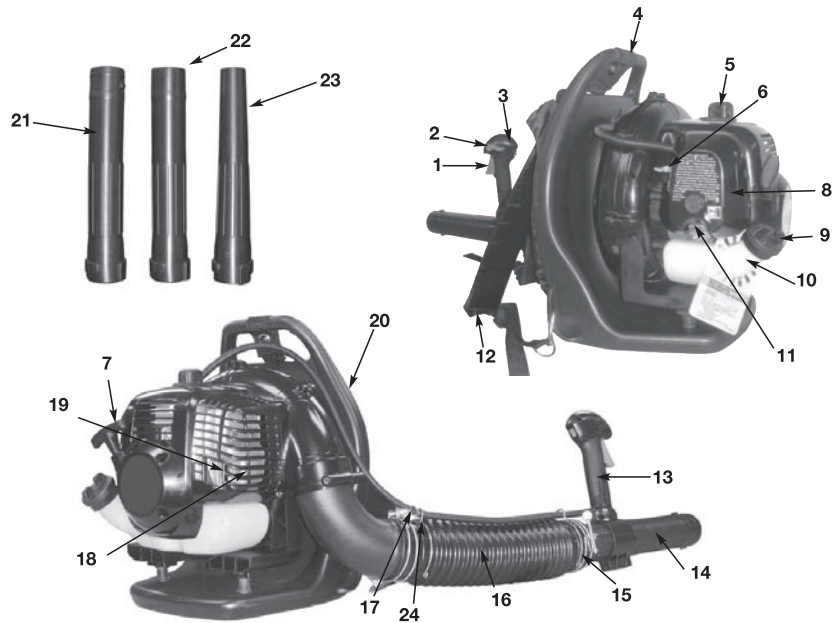

- | | | |
|---------------------------------|----------------------|------------------------------|
| 1. THROTTLE TRIGGER | 9. FUEL CAP | 18. MUFFLER COVER |
| 2. THROTTLE ADJUSTER | 10. FUEL TANK | 19. SPARK ARRESTER SCREEN |
| 3. ON/STOP SWITCH | 11. PRIMER BULB | 20. VENTED BACK PAD |
| 4. TOP ASSIST HANDLE | 12. HARNESS | 21. INTERMEDIATE TUBE |
| 5. SPARK PLUG WIRE / SPARK PLUG | 13. CONTROL HANDLE | 22. 56mm NOZZLE |
| 6. CHOKE LEVER | 14. OPERATING TUBE | 23. 40mm CONCENTRATOR NOZZLE |
| 7. STARTER HANDLE | 15. HOSE CLAMP | 24. THROTTLE LINKAGE CLIPS |
| 8. AIR CLEANER COVER | 17. THROTTLE LINKAGE | |

SPECIFICATIONS

Engine Type	Air-cooled, 2-Cycle
Engine displacement	30 cm ³ (1.83 ci)
Engine Speed	≥ 7,800 min ⁻¹
Idle Speed	3,400-4,400 min ⁻¹
Air Velocity	467 km/h
Air Output	13.11 m ³ /min
Spark Plug Gap	0.025 in (0.635 mm)
Fuel Capacity	18.5 oz (550 ml)
Dry Weight	6.4 kg
Sound power level	102 dB(A)
Sound pressure level at ear	94 dB(A)
Guarantee sound power level	104 dB(A)
Vibration	3.17m/s ²
EN ISO 22868 : 2005.	

ASSEMBLY INSTRUCTIONS

• ATTACH FLEX TUBE

Put the hose clamp(C) on the flex tube(B) before connecting the flex tube(B) and the fan's outlet tube(A) together.
Connect the flex tube (B) to the fan's outlet tube (A) (Fig. 1) with a hose clamp (C) (Fig.2) and tighten securely (Fig. 2).

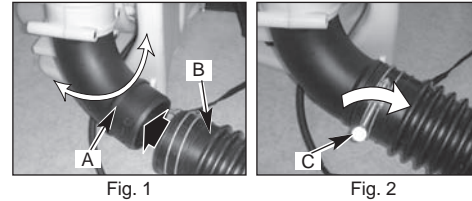

• ATTACH OPERATING TUBE

NOTE: keep the throttle cable as straight as possible when connecting the blower tubes.

- Place the unit on flat surface during assembly. Insure screw mechanism of clamp is positioned away from operator.
- Put the hose clamp (C) on the flex tube(B) and the operating tube before connecting them together.
- Turn the throttle linkage mark (D) so it aligns with the throttle handle (F) (Fig.3). Insert the operating tube (E) into the flex tube (B) (Fig. 3) and then tighten securely with a hose clamp (G) (Fig. 4).
- Attach throttle linkage clips to both ends of the flex tube to secure the throttle cable. (Fig. 6)

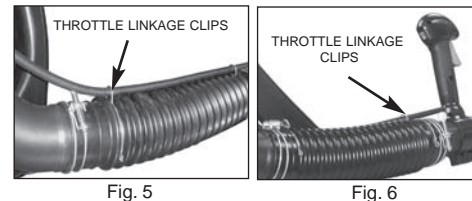
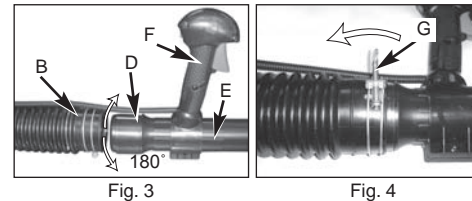

• ATTACH INTERMEDIATE TUBE AND CONCENTRATOR NOZZLE

Connect the intermediate tube (H) and concentrator nozzle (I) or 56mm nozzle (J) (you can only use one nozzle at a time). Push the tubes together and turn clockwise until they lock together (Fig. 7). Use concentrator nozzle when you need more airflow in tight places: flower beds, under decks, etc.

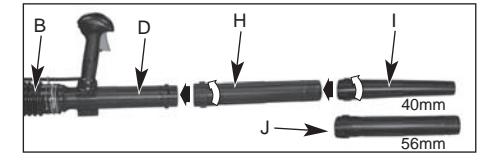

Fig. 7

• ADJUST BACK PACK AND HARNESS AND CONTROL HANDLE

- Place blower on your back by slipping arms through the shoulder straps as if you were putting on a jacket (Fig. 8).
- Once adjustments have been made, to the straps for user comfort, remove the blower from your back and place on level ground in an upright position.
- Adjust backpack harness and control handle.



Fig. 8

FUEL AND LUBRICATION

• FUEL

Use regular grade unleaded petrol mixed with 40:1 custom 2-cycle engine oil for best results. Use mixing ratios in Section FUEL MIXING TABLE.

WARNING: Never use straight petrol in your unit. This will cause permanent engine damage and void the manufacturer's warranty for that product. Never use a fuel mixture that has been stored for over 90 days.

WARNING: If 2-cycle lubricant other than Custom Lubricant is to be used, it must be a premium grade oil for 2-cycle air cooled engines mixed at a 40:1 ratio. Do not use any 2-cycle oil product with a recommended mixing ratio of 100:1. If insufficient lubrication is the cause of engine damage, it voids the manufacturer's engine warranty.

• MIXING FUEL

Add oil to an approved fuel container followed by the petrol to allow incoming petrol to mix with oil. Shake container to ensure thorough mix.

WARNING: Lack of lubrication voids engine warranty. Petrol and oil must be mixed at 40:1.

• FUEL AND LUBRICATION SYMBOLS

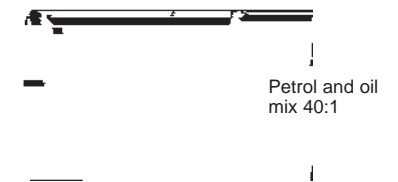

FUEL MIXING TABLE

PETROL	40:1	
1 U.S. Gal.	3.2 oz.	95ml (cm³)
5 Liters	4.3 oz.	125ml (cm³)
1 Imp. Gal.	4.3 oz.	125ml (cm³)
Mixing Ratio	40 Parts Petrol to 1 Part Lubricant	

RECOMMENDED FUELS

Some conventional petrols are being blended with oxygenates such as alcohol or an ether compound to meet clean air standards. Your engine is designed to operate satisfactorily on any petrol intended for automotive use including oxygenated petrol.

STARTING/STOPPING INSTRUCTIONS

STARTING A COLD ENGINE

NOTE: This product is designed to be started at idle.

1. Pump primer bulb 10 X by pressing up on the bulb (D). (Fig. 10)
2. Your unit is designed with a 3-position choke: FULL CHOKE, HALF CHOKE and RUN. Move choke lever to FULL CHOKE position. (Fig. 9)

NOTE: Easy Start power assist starting significantly reduces the pulling effort. Pull the starter cord slowly until fully extended, the power assist will turn over the engine with little resistance from the engine.

3. Squeeze throttle trigger and turn throttle adjuster clockwise until it stops.
Throttle adjuster position:
(1) Idling
(2) Full Throttle (Fig.11)
4. With the unit on the ground, hold the top assist handle and step on the bottom of the frame with your foot. (Fig.12)
Pull starter rope slowly until engine sounds as if it is trying to start, but do not pull rope more than 6 times.



Fig. 9

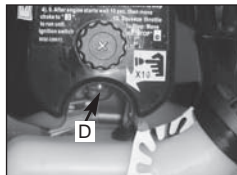

Fig. 10

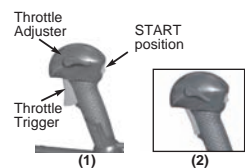

Fig. 11



Fig. 12

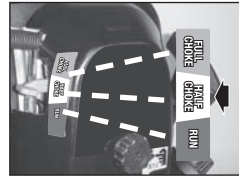

Fig. 13

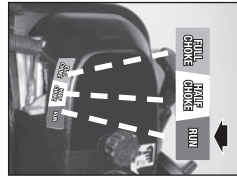

Fig. 14

5. Move choke lever to HALF CHOKE position. (Fig.13)
6. Pull starter rope slowly until engine starts.
7. Allow engine to run 10 seconds; then, move the choke lever to RUN position.(Fig.14)
8. Press trigger to run.

NOTE: Always pull starter rope straight out. Pulling starter at an angle will cause rope to rub against the eyelet. This friction will cause the rope to fray and wear more quickly. Always hold starter handle when rope retracts. Never let a rope snap back from extended position. This could cause rope to snag or fray and also damage the starter assembly.

STARTING A WARM ENGINE

1. Move choke lever to HALF CHOKE position. (Fig.13)
2. Pull starter rope slowly until engine starts.
3. Allow engine to run 10 seconds; then, move the choke lever to RUN position.(Fig.14)

NOTE: If engine has not started, pull starter rope 5 more pulls. If engine still does not run, it is probably flooded. Move the choke lever to the RUN position. Grip starter handle and pull starter rope slowly to clear the engine of excess fuel. If engine fails to start after repeated attempts, refer to troubleshooting section.

IMPORTANT IDLING INFORMATION

In some cases due to operating conditions (altitude, temperature etc.) your blower may need a slight adjustment to the idle speed. If unit does not idle after restarting 2 times after warm up, follow these steps to adjust idle.

1. Locate the idle adjustment screw (G) on the carburetor (Fig. 15).
2. Using a Phillips or slotted screwdriver - turn screw 1/4 to 1/2 turn clockwise (to the right). Unit should then idle properly.



Fig. 15

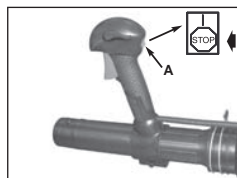

Fig. 16

STOPPING THE ENGINE

Emergency Stopping Procedure. When it is necessary to stop blower engine immediately, press and hold the ON/STOP switch (A) until the engine stops completely (Figure 16).

Normal Stopping Method. For normal stopping, release trigger and allow engine to return to idle speed. Then press and hold the ON/STOP switch (A) until the engine stops completely. (Figure 16)

BLOWER OPERATIONS

WARNING: Because of flying debris, always, approved shielded safety glasses or face shield when operating blower.

WARNING: Before using your blower, review Safety Precautions in your User Manual, and all regulations for operation of the unit. These precautions and regulations are for your protection.

WARNING: DO NOT operate the blower with other people or animals in the immediate vicinity. Allow a minimum of 30 feet (10 meters) between operator and other people or animals.

1. Use the blower for trees, shrubs, flower beds, and hard-to-clean areas.
2. Use the unit around buildings and for other normal cleaning procedures.
3. Use the blower around walls, overhangs, fences, and screens.
4. We recommend that a face mask be worn when operating blower in dusty areas.
5. Stand away from the debris, at a distance that will easily allow you to control the direction of blown debris. Never blow debris in direction of bystanders.
6. To control velocity of airstream, blower can be operated at any speed between idle and full throttle. Experience with the unit will help you determine the amount of airflow necessary for each application.
7. Operate power equipment only at reasonable hours-not early in the morning or late at night when people might be disturbed. Comply with times listed in local ordinances.
8. To reduce sound levels, limit the number of pieces of equipment used at any one time.
9. Operate power blowers at the lowest possible throttle speed to do the job.
10. Check your equipment before operation, especially the muffler, air intakes and air filters.
11. Use rakes and brooms to loosen debris before blowing. In dusty conditions, slightly dampen surfaces when water is available.
12. Conserve water by using power blowers instead of hoses for many lawn and garden applications, including areas such as gutters, screens, patios, grills, porches and gardens.
13. Watch out for children, pets, open windows or freshly washed cars, and blow debris safely away.
14. Use intermediate tube plus nozzle of your choice so the airstream can work close to the ground.
15. After using blowers and other equipment, CLEAN UP! Dispose of debris in trash receptacles.

OPERATION INSTRUCTIONS

1. Follow the instructions "STARTING A COLD ENGINE".
2. Once unit is running, place unit on your back by slipping arms through the shoulder straps as if you were putting on a jacket (Fig. 17).
3. When preparing to clear an area of debris, always position yourself so that you can control the direction debris will be blown. (Fig. 18)
4. The control handle and the flexibility of the blower tube assembly will allow you to clear the most hard-to-reach areas .
5. The hand grip, throttle trigger, throttle adjuster and ignition on/stop switch are all mounted on a swivel handle that offers a wide range of operating positions and comfort (Fig. 19).



Fig. 17



Fig. 18



Fig. 19

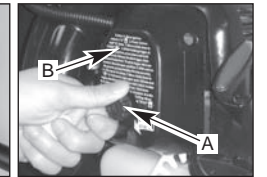

Fig. 20

MAINTENANCE INSTRUCTIONS

AIR FILTER

CAUTION: NEVER operate blower without the air filter or dust and dirt will be sucked into the engine and damage it. The air filter must be kept clean. If it becomes damaged, install a new filter.

To Clean Air Filter:

1. Loosen knob (A) holding air filter cover in place, remove cover (B) and lift filter (C) from air box (Fig. 20 & Fig. 21).
2. Wash filter in soap and water. **DO NOT USE PETROL!**
3. Air dry filter.
4. Reinstall air filter and air filter cover.

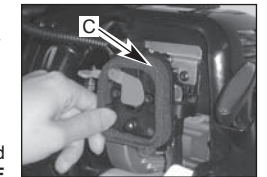

Fig. 21

NOTE: Replace filter if frayed, torn, damaged or unable to be cleaned.

FUEL CAP / FUEL FILTER



CAUTION: Remove fuel from unit and store in approved container before starting this procedure. Open fuel cap slowly to release any pressure which may have formed in fuel tank.

NOTE: Keep vent (A) on fuel cap clean of debris (Fig. 22).

Fuel Filter:

1. Completely remove fuel cap from fuel tank (B) to be able to remove fuel filter (C) from tank. Use a piece of wire (C) with a hook formed at the end to pull filter out of tank. (Fig. 23)
2. Pull off fuel filter (D) with a twisting motion.(Fig. 24).
3. Replace fuel filter.(Fig. 24).

NOTE: Never operate the blower without the fuel filter. Internal engine damage could result!

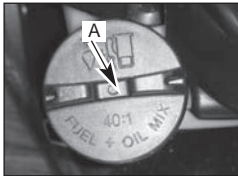

Fig. 22

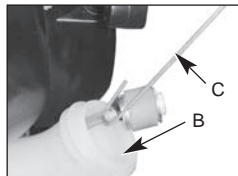

Fig. 23

CARBURETOR ADJUSTMENT

The carburetor was pre-set at the factory for optimum performance. If further adjustments are necessary take your blower to a qualified service dealer.

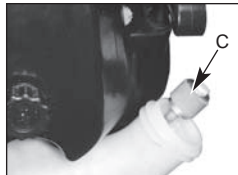

Fig. 24

SPARK PLUG

1. To remove spark plug (B) (Fig. 26) for cleaning or replacement: make sure engine is off, spark plug is cool, then grasp spark plug boot firmly and remove from spark plug. Remove spark plug with correct spark plug tool. Inspect, clean or replace as needed.
2. Spark plug gap = .025 in. (.635mm) (Fig. 25).
3. Torque to 105 to 130 inch pounds (12 to 15 N•m). Connect spark plug boot.
4. If need replace spark plug with Champion RZ7C or equivalent.

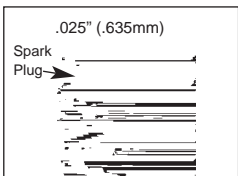

Fig. 25

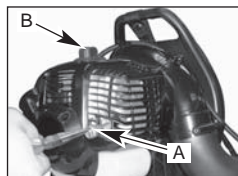

Fig. 26

SPARK ARRESTOR SCREEN / COLLAR ASSEMBLY

1. To replace spark arrestor screen/collar assembly (A) (Fig. 26), use a needle nose pliers and pinch an edge of the collar. Pull out the whole spark arrestor screen assembly.
2. Use the needle nose pliers to push in a new spark arrestor screen assembly by opening the pliers slightly to press the inner surface of the assembly securely into place

STORAGE



WARNING: Failure to follow these steps may cause varnish to form in the carburetor and difficult starting or permanent damage following storage.

1. Perform all the general maintenance recommended in the Maintenance Section of your User Manual.
2. Clean outside surface of unit.
3. Drain fuel from the fuel tank.
4. After fuel is drained, start engine.
5. Run engine at idle until unit stops. This will purge the carburetor of fuel.
6. Allow engine to cool (approx. 5 minutes).
7. Using a spark plug wrench, remove the spark plug.
8. Pour 1 teaspoon of clean 2 stroke engine oil into the combustion chamber. Pull starter rope slowly several times to coat internal components. Replace spark plug.
9. Store unit in a cool, dry place away from any source of ignition such as an oil burner, water heater, etc.

REMOVING A UNIT FROM STORAGE

1. Remove spark plug.
2. Pull starter rope briskly to clear excess oil from combustion chamber.
3. Clean spark plug or install a new spark plug with proper gap.(Fig. 25)
4. Prepare unit for operation.
5. Fill fuel tank with proper fuel / oil mixture. See Fuel and Lubrication Section.

TROUBLE SHOOTING THE ENGINE

PROBLEM	PROBABLE CAUSE	CORRECTIVE ACTION
Unit won't start or starts but will not run.	Incorrect starting procedures. Incorrect carburetor mixture adjustment setting. Fouled spark plug. Empty fuel tank. Primer bulb was not pressed enough.	Follow instructions in the User Manual. Have carburetor adjusted by an Authorized Service Center. Clean/gap or replace plug. Fill fuel tank with properly mixed fuel. Press primer bulb fully and slowly 10 times.
Unit starts, but engine has low power.	Fuel filter is plugged. Incorrect lever position. Dirty spark arrestor screen. Dirty air filter. Incorrect carburetor mixture adjustment setting service dealer.	Replace the fuel filter. Move to RUN position. Replace spark arrestor screen. Remove, clean and reinstall filter. Have carburetor adjusted by an Authorized Service Center.
Engine hesitates.	Incorrect carburetor mixture adjustment setting. Air filter is plugged. Old or improperly mixed fuel.	Have carburetor adjusted by an Authorized Service Center. Replace or clean the air filter. Drain fuel tank/add fresh fuel mixture.
No power under load.	Incorrect carburetor mixture adjustment setting. Old or improperly mixed fuel. Air filter is plugged. Fouled spark plug.	Have carburetor adjusted by an Authorized Service Center. Drain fuel tank (see storage)/add fresh fuel mixture. Replace or clean the air filter. Replace or clean the spark plug.
Runs erratically.	Incorrectly gapped spark plug. Plugged spark arrestor. Dirty air filter.	Clean/gap or replace plug. Clean or replace spark arrestor. Clean or replace air filter.
Smokes excessively.	Incorrect carburetor mixture adjustment setting. Incorrect fuel mixture.	Have carburetor adjusted by an Authorized Service Center. Use properly mixed fuel(40:1 mixture).



EU Declaration of Conformity

according to the regulations 98/37/EC, 2004/108/EC,
2000/14/EC+2005/88/EC, 2004/26/EC

For the following equipment / product : Petrol Back Pack Blower
Type Designation : MAC BP290
Trademark : McCULLOCH
Importer's Name : Husqvarna AB
Importer's Address : SE-561 82 Huskvarna, Sweden

We herewith confirm to comply with the requirements set out in the Council Directive 98/37/EC, 2004/108/EC, 2000/14/EC+2005/88/EC, 2004/26/EC.
For the evaluation of the compliance with these Directives, the following standards were applied:

EN ISO 14982:1998

Sound pressure level : 94 dB(A)
Sound power level : 102 dB(A)
Guarantee sound power level : 104 dB(A)

Person responsible for making this declaration

Name, surname : Ronnie Goldman
Position/Title : Director of Engineering
Handheld Consumer Products

Shanghai P.R.C. 2008/12/11