

Flymo

 Electrolux

McCULLOCH

 Electrolux

HT42 / HT420 HT450 / HT600

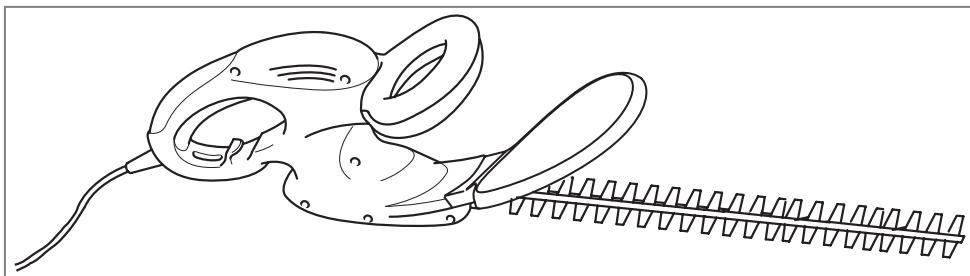

GB

IMPORTANT INFORMATION

Read before use and retain for future reference

D

WICHTIGE INFORMATION

Bitte vor dem Benutzen des Gerätes durchlesen und gut aufbewahren

F

RENSEIGNEMENTS IMPORTANTS

A lire avant usage et à conserver pour référence ultérieure

NL

BELANGRIJKE INFORMATIE

Leest u deze informatie voor het gebruik en bewaar ze voor toekomstige raadpleging

N

VIKTIG INFORMASJON

Les bruksanvisningen nøye før bruk og oppbevar den for senere bruk

SF

TÄRKEÄÄ TIETOJA

Lue tämä ennen käyttöä ja säilytä myöhempää tarvetta varten

S

VIKTIG INFORMATION

Läs anvisningarna före användningen och spara dem för framtida behov

DK

VIGTIGE OPLYSNINGER

Du bør læse brugsanvisningen før brug og gemme til senere henvisning

E

INFORMACIÓN IMPORTANTE

Léase antes de utilizar y consérvela como referencia en el futuro

P

INFORMAÇÕES IMPORTANTES

Leia antes de utilizar e guarde para consulta futura

I

INFORMAZIONI IMPORTANTI

Leggere prima dell'uso e conservare per ulteriore consultazione

HU

Jótállást vállalni csak rendeltetés szerűen használatba vett gépekre tudunk. Kérjük, hogy a gép használatba vétele előtt gondosan olvassa el a kezelési utasításokat.

PL

Gwarancja traci ważność w przypadku używania urządzenia do celów innych niż wymienione w instrukcji obsługi. Prosimy o uważne przeczytanie instrukcji oraz o stosowanie się do zaleceń i wskazówek w niej zawartych

CZ

Záruka se nebude vztahovat na závady způsobené nesprávným používáním, nebo jestliže bude výrobek použit pro jiné účely než pro jaké byl vyroben, nebo také jinak než je uvedeno v návodu k obsluze. Tento návod si přečtěte, prosím, velmi pozorně a uchovejte jej pro možné budoucí odkazy

SK

Záruka na tento produkt nebude uznaná v prípade porúch spôsobených nesprávnou obsluhou alebo používaním výrobku na iný účel alebo iným spôsobom, ako je uvedené. Pred začatím práce si prosím dôkladne prečítajte návod na obsluhu a tento si aj pre prípad potreby uschovajte

SL

Garancija ne velja ob nepravilni uporabi proizvoda in/ali ob uporabi za drugi namen kot je izdelan. Prosimo, da pred uporabo, preverite pazljivo navodila za obratovanje in jih shranite za kasnejšo rabo.

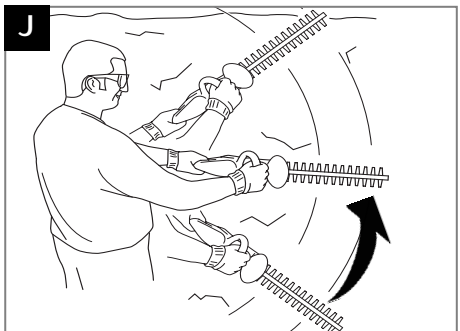
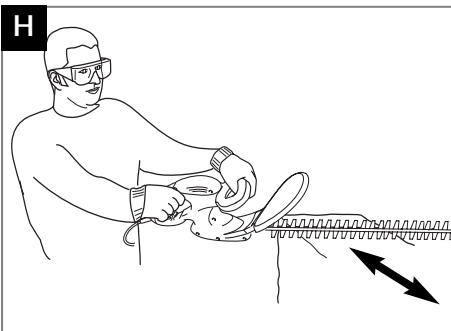
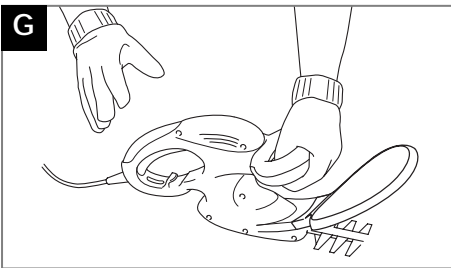
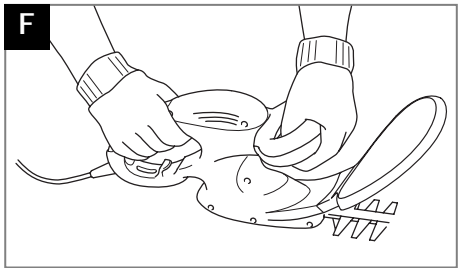
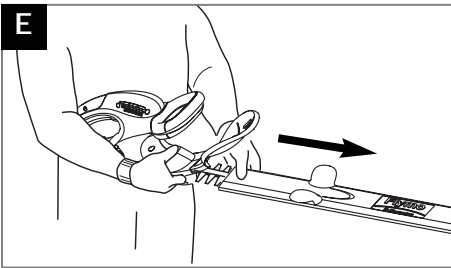
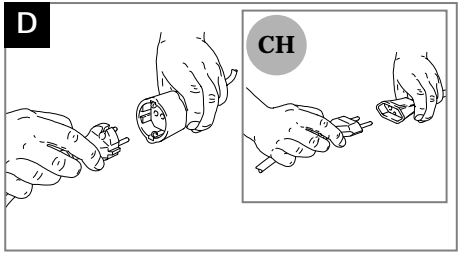
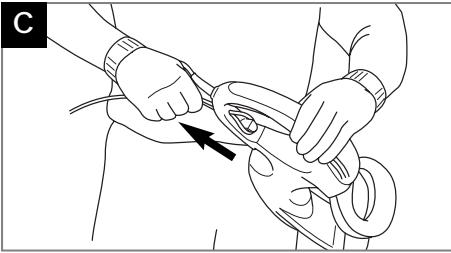
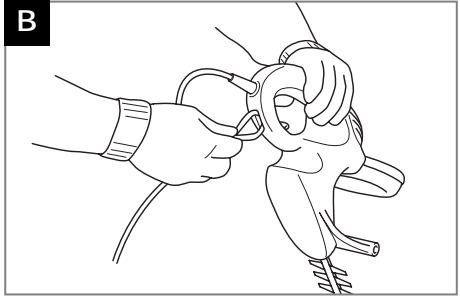
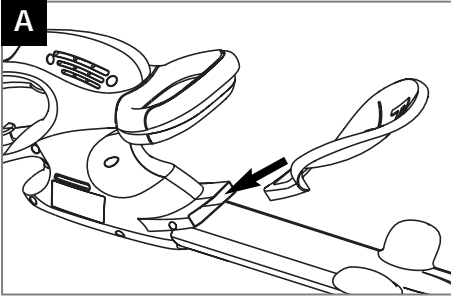

K

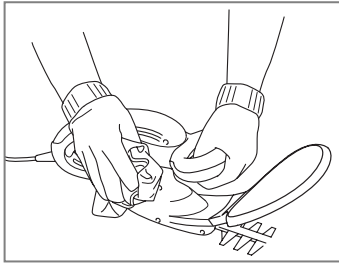
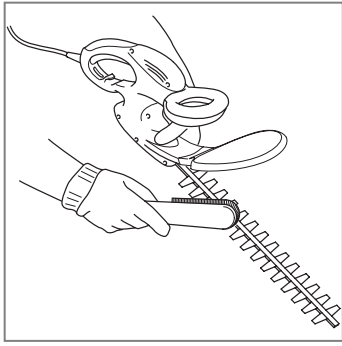
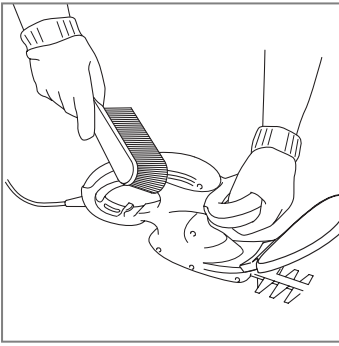

L

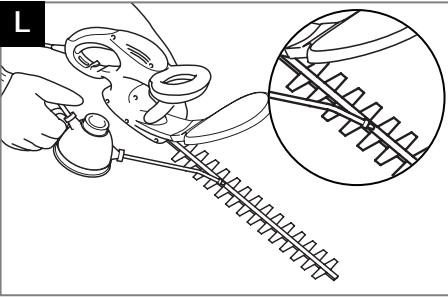

M

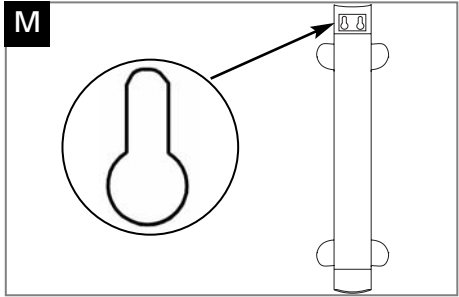

N

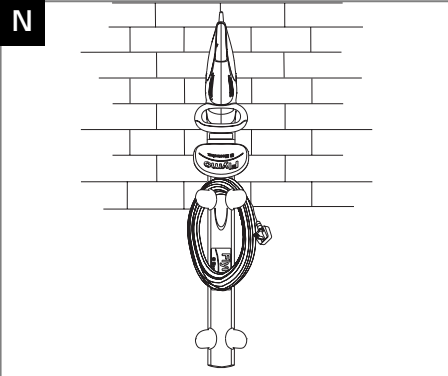

P

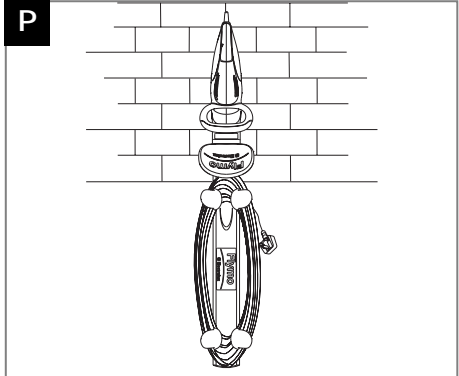

GB - CONTENTS

1. Switch levers
2. Instruction Manual
3. Handguard
4. Blade cover/Storage Holder
5. Warning Label
6. Product Rating Label

DE - INHALT

1. Ein/Aus-Schalter
2. Bedienungsanweisung
3. Schnittschutz
4. Klingenschutz
5. Warnetikett
6. Produkttypenschild

FR - TABLE DES MATIÈRES

1. Poignée à double commande
2. Manuel d'instructions
3. Ecran protecteur
4. Fourreau protège-lames
5. Etiquette d'avertissement
6. Plaque des Caractéristiques du Produit

NL - INHOUD

1. Schakelhendels
2. Handleiding
3. Handbescherming
4. Messchede/opberghoes
5. Waarschuwingsetiket
6. Product-informatielabel

NO - INNHOLD

1. Bryterhåndtak
2. Bruksanvisning
3. Beskyttelsesskjerm/hand-beskytter
4. Bladbeskytter
5. Advarselsetikett
6. Produktmerking

FI - SISÄLTÖ

1. Käynnistysvivut
2. Käyttöopas
3. Kädensuoja
4. Teränsuoja
5. Varoitusunimike
6. Ruohonleikkurin arvokilpi

SE - INNEHÅLL

1. Strömbrytare
2. Bruksanvisning
3. Handskydd
4. Bladskydd/förvaring-sfodral
5. Varningsetikett
6. Produktmärkning

DK - INDHOLD

1. Håndgreb
2. Brugsvejledning
3. Håndbeskyttelse
4. Klingskede/-holder
5. Advarselsmærkat
6. Produktets mærkeskilt

ES - CONTENIDO

1. Interruptores
2. Manual de Instrucciones
3. Defensa
4. Cubierta de la Cuchilla/portacuchillas
5. Etiqueta de Advertencia
6. Placa de Características del Producto

PT - LEGENDA

1. Interruptores de alavanca
2. Manual de Instruções
3. Resguardo para a mão
4. Cobertura/capa de armazenamento das lâminas
5. Etiqueta de Aviso
6. Rótulo de Avaliação do Produto

IT - NOMENCLATURA

1. Leve di avviamento
2. Manuale di istruzioni
3. Schermo di protezione delle mani
4. Coprilama/portacasoio
5. Etichetta di pericolo
6. Etichetta dati del prodotto

HU - TARTALOMJEGYZÉK

1. Kapcsolókarok
2. Kezelési útmutató
3. Kézvédő
4. Késtk/tárolótok
5. Figgelmeztesítő címke
6. Termékminősítő címke

PL - ZAWARTOSC KARTONU

1. Dźwignienki włączające
2. Instrukcja Obsługi
3. Osłona dłoni
4. Osłona ostrzy / uchwyt do przechowywania
5. Znaki bezpieczeństwa
6. Tabliczka znamionowa

CZ - OBSAH KARTONU

1. Páky spínače
2. Návod k obsluze
3. Ochrana rukou
4. Kryt nože/držák ke skladování
5. Výstražný štítek
6. Typový štítek výrobku

SK - OBSAH

1. Zapínacie páky
2. Príručka
3. Chránič ruky
4. Kryt čepele/uskladňovací držiak
5. Varovný štítok
6. Prístrojový štítok

SI - VSEBINA

1. Stikalne ročke
2. Priročnik
3. Ščitnik za roke
4. Pokrival rezila/shranjevalnik
5. Opozorilna Oznaka
6. Napisna Tablica

(GB)	CARTON CONTENTS	(SE)	FÖRPACKNINGENS INNEHÅLL	(HU)	A DOBOZ TARTALMA
(DE)	KARTONINHALT	(DK)	KARTONINDHOLD	(PL)	ZAWARTOŚĆ KARTONU
(FR)	CONTENU DU CARTON	(ES)	CONTENIDO DEL CARTON	(CZ)	OBSAH KRABICE
(NL)	INHOUD	(PT)	LEGENDAS DOS DESENHOS	(SK)	OBSAH BALENIA
(NO)	KARTONGEN INNEHOLDER	(IT)	CONTENUTO	(SI)	VSEBINA ŠKATLE
(FI)	PAKETIN SISÄLTÖ				

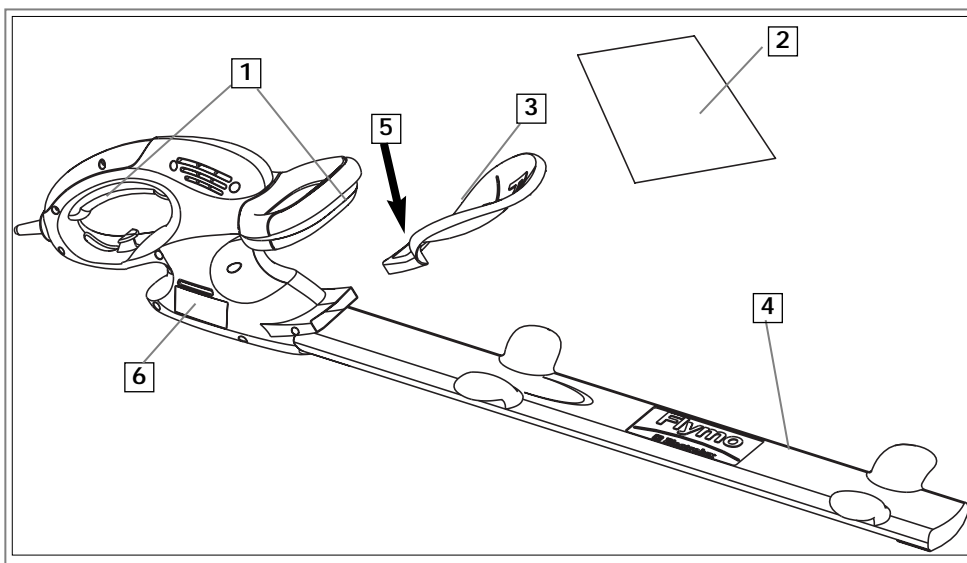

SAFETY PRECAUTIONS



If not used properly this Hedgetrimmer can be dangerous! This Hedgetrimmer can cause serious injury to the operator and others, the warnings and safety instructions must be followed to ensure reasonable safety and efficiency in using this Hedgetrimmer. The operator is responsible for following the warning and safety instructions in this manual and on the Hedgetrimmer.

Explanation of Symbols on the HT42, HT420, HT450, HT600



Warning.



Read the user instructions carefully to make sure you understand all the controls and what they do.



Switch off! Remove plug from mains before adjusting, cleaning or if cable is entangled or damaged. Keep the cable away from the blade.



Do not use in the rain or leave the Hedgetrimmer outdoors while raining.



The use of eye protection is recommended.

General

1. Never allow children or people unfamiliar with these instructions to use the Hedgetrimmer. Local regulations may restrict the age of the operator.
2. Only use the Hedgetrimmer in the manner and for the functions described in these instructions.
3. Never operate the Hedgetrimmer when you are tired, ill or under the influence of alcohol, drugs or medicine.
4. The operator or user is responsible for accidents or hazards occurring to other people or their property.

Electrical

1. The use of a Residual Current Device (R.C.D.) with a tripping current of not more than 30mA is recommended. Even with a R.C.D. installed 100% safety cannot be guaranteed and safe working practice must be followed at all times. Check your R.C.D. every time you use it.

2. Before use, examine cable for damage, replace it if there are signs of damage or ageing.
3. Do not use the Hedgetrimmer if the electric cables are damaged or worn.
4. Immediately disconnect from the mains electricity supply if the cable is cut, or the insulation is damaged. Do not touch the electric cable until the electrical supply has been disconnected. Do not repair a cut or damaged cable. Replace it with a new one.
5. Your electric cable must be uncoiled, coiled cables can overheat and reduce the efficiency of your Hedgetrimmer.
6. Keep cable away from the cutting area.
7. Do not pull cable around sharp objects.
8. Always switch off at the mains before disconnecting any plug, cable connector or extension cable.
9. Switch off, remove plug from mains and examine electric supply cable for damage or ageing **before** winding cable for storage. Do not repair a damaged cable, replace it with a new one. Use only Electrolux replacement cable.
10. Always wind cable carefully, avoiding kinking.
11. Never carry the product by the cable.
12. Never pull on the cable to disconnect any of the plugs.
13. Use only on AC mains supply voltage shown on the product rating label.
14. Electrolux products are double insulated to EN60335. Under no circumstance should an earth be connected to any part of the product.

Cables

Use only 1.00mm² size cable up to 30 metres length maximum.

Maximum rating:

1.00mm² size cable 10 amps 250 volts AC

1. Mains cables and extensions are available from your local Electrolux Outdoor Products Approved Service Centre.
2. Only use extension cables specifically designed for outdoor use.

Preparation

1. Always wear suitable clothing, gloves, and stout shoes. The use of safety glasses is recommended. Do not wear loose clothing or jewellery which can be caught in moving parts.
2. Thoroughly inspect the area where the Hedgetrimmer is to be used and remove all

SAFETY PRECAUTIONS

- wires and other foreign objects.
3. Before using the machine and after any impact, check for signs of wear or damage and repair as necessary
 4. Always ensure the hand guard supplied is fitted before using the Hedgetrimmer. Never attempt to use an incomplete Hedgetrimmer or one with an unauthorised modification.

Use

1. Use the Hedgetrimmer only in daylight or good artificial light.
2. Avoid operating your Hedgetrimmer on a wet hedge, where feasible.
3. Know how to stop the Hedgetrimmer quickly in an emergency.
4. Never hold the Hedgetrimmer by the guard.
5. Never operate the Hedgetrimmer with damaged guards or without guards in place.
6. Remove plug from mains **before** passing Hedgetrimmer to another person.
7. Avoid operating while people especially children are nearby.
8. Whilst using the Hedgetrimmer always be sure of a safe and secure operating position.
9. Keep hands and feet away from the cutting means at all times and especially when switching on the motor.
10. Do not use stepladders whilst operating the Hedgetrimmer.

11. Remove the plug from the mains :-

- before leaving the Hedgetrimmer unattended for any period;
- before clearing a blockage;
- before checking, cleaning or working on the appliance;
- if you hit an object. Do not use your Hedgetrimmer until you are sure that the entire Hedgetrimmer is in a safe operating condition;
- if the Hedgetrimmer starts to vibrate abnormally. Check immediately. Excessive vibration can cause injury.
- before passing to another person.

Maintenance and storage

1. Keep all nuts, bolts and screws secure to be sure the Hedgetrimmer is in safe working condition.
2. Replace worn or damaged parts for safety.
3. Be careful during adjustment of the Hedgetrimmer to prevent entrapment of the fingers between moving blades and fixed parts of the machine.
4. After use the Hedgetrimmer should be stored using the blade cover/storage holder provided.

Assembly

Assembly of Handguard.

1. Insert Handguard into slot as illustrated in **figure A**, ensuring that it is securely located.

DO NOT USE THE PRODUCT WITHOUT FITTING THE HANDGUARD

STARTING AND STOPPING

Before starting your Hedgetrimmer.

1. Form a loop in mains cable and push the loop through the hole in the cable holder as illustrated in **Fig. B**.
2. To secure, position the loop around the hook as illustrated in **Fig. C**.
3. Connect female extension cable connector to the male plug lead on your product. (**Fig D**)
4. Connect to mains and switch on
5. Remove blade cover/storage holder as illustrated in **Fig. E**.

To start your Hedgetrimmer

1. There are two switch levers fitted to your Hedgetrimmer.
2. Both switch levers need to be held in the operating position (**Fig F**) for the product to start.

To stop your Hedgetrimmer

- Move Hedgetrimmer away from cutting area before stopping.
1. To stop, release **one** switch lever (**Fig G**).

How to Use

How to Use your Hedgetrimmer

1. Inspect area to be cut before each use - remove objects which can be thrown or become entangled in the cutting blades.
2. Always keep the Hedgetrimmer in front of your body. Hold handle firmly with both hands and stand in a secure and stable position.
3. Allow the cutting blades to reach full speed before entering the material to be cut.
4. Always work going away from people and solid objects such as walls, large stones, trees, vehicles etc.
5. If blade stalls, immediately stop the Hedgetrimmer. Disconnect the Hedgetrimmer

from the power source and clear jammed debris from the cutting blades. Inspect blades and repair or replace as needed.

Top Cutting

Use a wide sweeping motion. (Fig. H) A slight downward tilt of the cutting blades in the direction of motion gives the best cutting results.

Side Cutting

When trimming the sides of the hedge, begin at the bottom and cut upwards (Fig. J), tapering the hedge inward at the top. This shape will expose more of the hedge, resulting in more uniformed growth.

Caring for your Hedgetrimmer

Cleaning (K)

• USE GLOVES

1. Using a soft brush - remove debris from all air intakes and cutting blade.

2. Wipe over surface of your hedgetrimmer with a dry cloth.

• IMPORTANT

Never use water for cleaning your hedgetrimmer. Do not clean with chemicals, including petrol, or solvents - some can destroy critical plastic parts.

Lubricating the Cutting Blade

For easier operation and longer life, lubricate the cutter blades before and after use. Apply the oil so that it runs between the two blades. See Pic L.

At the end of the Cutting Season.

1. Clean your Hedgetrimmer thoroughly.
2. Check that all nuts and bolts are secure.

3. Visually inspect the Hedgetrimmer for any worn or damaged parts, contact your local Service Centre if any parts require replacement.

To store your Hedgetrimmer

• The Hedgetrimmer blade cover/storage holder is provided with 2 hanging slots for storing the Hedgetrimmer on the wall. (M)

• Ensure the blade cover/storage holder is fitted before storage.

1. The use of 2 number 10 screws (40mm in length) and the appropriate wall fixing plugs is recommended
2. Drill 2 horizontal holes 47mm apart.
3. Fit wall plugs.

4. Fit screw ensuring enough length is available for secure location into hanging slot.

• Your mains cable can be stored with the blade cover/storage holder fitted. (Pic N & P)

• Store in a dry place where your hedgetrimmer is protected from damage.

Fault Finding Hints

Fails to Operate

1. Is the Power Turned On?
2. Check the fuse in the plug, if blown replace.
3. Fuse continues to blow?

Disconnect from the mains electricity supply and consult your local approved Electrolux Outdoor Products Service Centre.

Cutting blade stops under load

1. Cut at a slower pace.
2. If cutting blade still stops under load?
Disconnect from the mains electricity supply and consult your local approved Electrolux Outdoor Products Service Centre.

Cutting blade stops under load

1. Cut at a slower pace.
2. If cutting blade still stops under load?
Disconnect from the mains electricity supply and consult your local approved Electrolux Outdoor Products Service Centre.

Fails to stop when one switch lever is released.

Disconnect from the mains electricity supply and consult your local approved Electrolux Outdoor Products Service Centre.

Poor cut quality

1. Ensure the product is being used correctly (see How to Use)
2. Ensure blades are free from trapped debris
3. Damaged Blades?

Disconnect from the mains electricity supply and consult your local approved Electrolux Outdoor Products Service Centre.

Excessive Vibration

Disconnect from the mains electricity supply and consult your local approved Electrolux Outdoor Products Service Centre.

Service Recommendations

- Your product is uniquely identified by a silver and black product rating label.
- We strongly recommend that your product is serviced at least every twelve months, more often in a professional application.

Guarantee and Guarantee Policy

Guarantee & Guarantee Policy

If any part is found to be defective due to faulty manufacture within the guarantee period, Electrolux Outdoor Products, through its Authorised Service Repairers will effect the repair or replacement to the customer free of charge providing:

- (a) The fault is reported directly to the Authorised Repairer.
 - (b) Proof of purchase is provided.
 - (c) The fault is not caused by misuse, neglect or faulty adjustment by the user.
 - (d) The failure has not occurred through fair wear and tear.
 - (e) The machine has not been serviced or repaired, taken apart or tampered with by any person not authorised by Electrolux Outdoor Products.
 - (f) The machine has not been used for hire.
 - (g) The machine is owned by the original purchaser.
 - (h) The machine has not been used outside of the country for which it was specified.
 - (i) The machine has not been used commercially.
- * This guarantee is additional to, and in no way diminishes the customers statutory rights.

Failures due to the following are not covered, therefore it is important that you read the instructions contained in this Operator's Manual and understand how to operate and maintain your machine:

Failures not covered by guarantee

- * Replacing worn or damaged blades.
- * Failures as a result of not reporting an initial fault.
- * Failures as a result of sudden impact.
- * Failures as a result of not using the product in accordance with the instructions and recommendations contained in this Operator's Manual.
- * Machines used for hire are not covered by this guarantee.
- * The following items listed are considered as wearing parts and their life is dependent on regular maintenance and are, therefore not normally subject to a valid warranty claim: Blade, Electric Mains cable.
- * **Caution!** Electrolux Outdoor Products does not accept liability under the warranty for defects caused in whole or part, directly or indirectly by the fitting of replacement parts or additional parts that are not either manufactured or approved by Electrolux Outdoor Products, or by the machine having been modified in any way

Environmental Information

Electrolux Outdoor Products are manufactured under an Environmental Management System (ISO 14001) using, where practical, components manufactured in the most environmentally responsible manner, according to company procedures, and with the potential for recycling at the end of the products' life.

- Packaging is recyclable and plastic components have been labelled (where practical) for categorised recycling.
- Awareness of the environment must be considered when disposing of 'end-of-life' product.
- If necessary, contact your local authority for disposal information.

EC DECLARATION OF CONFORMITY

<p>I, the undersigned M. Bowden of Electrolux Outdoor Products, Aycliffe Industrial Park, NEWTON AYCLIFFE, Co. Durham. DL5 6UP. Certify that the Product-Category..... Hedgetrimmer Make..... Electrolux Outdoor Products Conforms to the specifications of Directive 2000/14/EEC</p>	<p>I, the undersigned M. Bowden of Electrolux Outdoor Products, Aycliffe Industrial Park, NEWTON AYCLIFFE, Co. Durham. DL5 6UP. Certify that a sample of the above product has been tested using directive 81/1051/EEC as a guide. The maximum A-weighted sound pressure level recorded at operator position under free field semi anechoic chamber conditions was :-</p>	<p>I, the undersigned M. Bowden of Electrolux Outdoor Products, Aycliffe Industrial Park, NEWTON AYCLIFFE, Co. Durham. DL5 6UP. Certify that a sample of the above product has been tested using ISO 5349 as a guide. The maximum weighted root mean square value of vibration recorded at operator's hand position was:-</p>
<p>Identification of Series..... See Product Rating Label Conformity Assessment Procedure.....ANNEX VI Notified Body..... I.T.S., Cleeve Road, Leatherhead, Surrey, KT22 7SB. England. Other Directives:..... 98/37/EEC, 89/336/EEC, 73/23/EEC & applicable standards:- EN60555-2:1987, EN60555-3:1987, EN55014:1993, EN55014:1995, EN774:1996, EN50144-1:1995, EN50144-2-15:1997</p>	<p>Type..... A Watts..... B Guaranteed sound power level..... C Measured Sound Power Level..... D Level..... E Value..... F Weight..... G</p>	

EC KONFORMITÄTSEKTLÄRUNG

<p>Ich, der Unterzeichner M. Bowden of Electrolux Outdoor Products, Aycliffe Industrial Park, NEWTON AYCLIFFE, Co. Durham. DL5 6UP. Bescheinigung, dass das Produkt- Kategorie.... Heckenscherer Fabrikat..... Electrolux Outdoor Products die Spezifikationen der Direktive 2000/14/EG erfüllt</p>	<p>Ich, der Unterzeichner M. Bowden, Electrolux Outdoor Products, Aycliffe Industrial Park, NEWTON AYCLIFFE, Co. Durham, DL5 6UP, bescheinige hiermit, daß eine Probe des obigen Produkts getestet wurde und dabei Direktive 81/1051/EVG als Richtschnur verwendet wurde. Der maximale A-gewichtete Schalldruckpegel, der an der Bedienereposition unter Freifeld-Halbschalltot-Kammerbedingungen gemessen wurde, betrug:-</p>	<p>Ich, der Unterzeichner M. Bowden, Electrolux Outdoor Products, Aycliffe Industrial Park, NEWTON AYCLIFFE, Co. Durham, DL5 6UP, bescheinige hiermit, daß eine Probe des obigen Produkts getestet wurde und dabei ISO 5349 als Richtschnur verwendet wurde. Der maximale gewichtete Vibrationseffektivwert, der an der Handposition des Bedieners gemessen wurde, betrug:-</p>
<p>Identifizierung der reihe..... Siehe Produkttypenschild Konformitätsbestätigungsverfahren.....ANNEX VI Benachrichtigte Behörde.....I.T.S., Cleeve Road, Leatherhead, Surrey, KT22 7SB. England. Andere Direktiven..... 98/37/EEC, 89/336/EEC, 73/23/EEC und Normen:-.....EN60555-2:1987, EN60555-3:1987, EN55014:1993, EN55014:1995, EN774:1996, EN50144-1:1995, EN50144-2-15:1997</p>	<p>Typ..... A Watts..... B Garantierter Geräuschpegel..... C Gemessener Geräuschpegel..... D Höhe E Wert..... F Gewicht..... G</p>	

EC DÉCLARATION DE CONFORMITÉ

<p>Je soussigné M. Bowden of Electrolux Outdoor Products, Aycliffe Industrial Park, NEWTON AYCLIFFE, Co. Durham. DL5 6UP. Certifie que ce produit- Catégorie..... Taille-haie Marque..... Electrolux Outdoor Products est conforme aux spécifications de la Directive 2000/14/EEC</p>	<p>Je soussigné M. Bowden, Electrolux Outdoor Products, Aycliffe Industrial Park, NEWTON AYCLIFFE, Co. Durham, DL5 6UP, Grande-Bretagne, certifie qu'un échantillon du produit ci-dessus a été essayé selon les indications de la directive 81/1051/EEC. Le niveau maximum pondéré de pression acoustique enregistré à la position de l'opérateur en champ libre en chambre demi-sourde était de:-</p>	<p>Je soussigné M. Bowden, Electrolux Outdoor Products, Aycliffe Industrial Park, NEWTON AYCLIFFE, Co. Durham, DL5 6UP, Grande-Bretagne, certifie qu'un échantillon du produit ci-dessus a été essayé selon les indications de la norme ISO 5349. La moyenne quadratique pondérée des vibrations enregistrées à la position de la main de l'opérateur était de:-</p>
<p>Identification de la serie..... Voir la Plaquette D'identification Procédure d'évaluation de la conformité.....ANNEX VI Organisme notifié.....I.T.S., Cleeve Road, Leatherhead, Surrey, KT22 7SB. England. Autres directives..... 98/37/EEC, 89/336/EEC, 73/23/EEC et aux normes.....EN60555-2:1987, EN60555-3:1987, EN55014:1993, EN55014:1995, EN774:1996, EN50144-1:1995, EN50144-2-15:1997</p>	<p>Type..... A Watts..... B Niveau garanti de puissance sonore..... C Niveau mesuré de puissance sonore..... D Niveau..... E Valeur..... F Poids..... G</p>	

EC CONFORMITEITSVERKLARING

<p>Ik, ondergetekende M. Bowden of Electrolux Outdoor Products, Aycliffe Industrial Park, NEWTON AYCLIFFE, Co. Durham. DL5 6UP. Verklaaren dat het product- Categorie.... Heggenschaar Merk..... Electrolux Outdoor Products Voldoet aan de specificaties van directief 2000/14/EEC</p>	<p>Ik, ondergetekende M. Bowden, Electrolux Outdoor Products, Aycliffe Industrial Park, NEWTON AYCLIFFE, Co. Durham, DL5 6UP, verklaar hierbij dat een profexemplaar van het bovengenoemde product is getest volgens richtlijn 81/1051/EEC. Het maximale A-belaste geluidsdrukniveau dat is geregistreerd bij de positie van de bediener in een semi geluidsdichte ruimte bij vrije veld condities bedraagt:-</p>	<p>Ik, ondergetekende M. Bowden, Electrolux Outdoor Products, Aycliffe Industrial Park, NEWTON AYCLIFFE, Co. Durham, DL5 6UP, verklaar hierbij dat een profexemplaar van het bovengenoemde product is getest volgens ISO 5349 als richtlijn. De maximale belast effectieve waarde van trilling, geregistreerd bij de positie van de hand van de bediener, bedraagt:-</p>
<p>Identificatie van serie..... Zie Productlabel Procedure voor het beoordelen van conformiteit.....ANNEX VI Op de hoogte gestelde instantie.....I.T.S., Cleeve Road, Leatherhead, Surrey, KT22 7SB. England. Andere directieven..... 98/37/EEC, 89/336/EEC, 73/23/EEC aan aan de volgende normen..... EN60555-2:1987, EN60555-3:1987, EN55014:1993, EN55014:1995, EN774:1996, EN50144-1:1995, EN50144-2-15:1997</p>	<p>Type..... A Watts..... B Gegarandeerd geluidsvermogen..... C Gemeten geluidsvermogen..... D Niveau..... E Waarde..... F Gewicht..... G</p>	

A	HT42
B	380 W
C	101 dB (A)
D	98 dB (A)
E	90 dB(A)
F	4.04 m/s ²
G	3.2 kg

A	HT450
B	450 W
C	105 dB (A)
D	97 dB (A)
E	91 dB(A)
F	4.6 m/s ²
G	3.2 kg

A	HT420
B	400 W
C	101 dB (A)
F	98 dB (A)
E	90 dB(A)
F	4.04 m/s ²
G	3.2 kg

A	HT600
B	500 W
C	101 dB (A)
D	98 dB (A)
E	95 dB(A)
F	7.5 m/s ²
G	3.5 kg



Newton Aycliffe, 07/08/2003
M. Bowden,
Research & Development Director

BELGIQUE/BELGIË	Flymo Belgique/België Tel: 02 363 0311, Fax: 02 363 0391
ČESKÁ REPUBLIKA	Electrolux, spol. s.r.o., oz Electrolux Outdoor Products, Na Křečku 365, Praha 10 - Horní Měcholupy. Tel: 02/7847 0164, Info-linka: 0800/110 220 Internet: www.partner-flymo.cz E-mail: info@husqvarna.cz
DANMARK	Electrolux Outdoor Products, Flymo/Partner A/S, Lundtoftegaardsvej 93A, DK 2800 Kgs.Lyngby Tel: 45 87 75 77, Fax: 45 93 33 08, www.flymo-partner.dk
DEUTSCHLAND	Flymo Deutschland Tel: 097 21 7640, Fax:097 21 764202
ESTONIA	Electrolux Estonia Ltd (Electrolux Eesti AS) Tel: (372) 6650010
FRANCE	Flymo France SNC Tel 01 46 67 8141, Fax 01 43 34 2491
FINLAND SUOMI	Electrolux Outdoor Products Finland Tel: 00 358 9 39611, Fax: 00 358 9 3961 2644
ITALIA	McCulloch Italiana s.r.l. - Via Como 72, 23868 Valmadrera (LECCO) - ITALIA Tel: 800 017829, Fax: 0341 581671
IRELAND	Flymo Ireland Tel: 01 4565222, Fax: 01 4568551
MAGYARORSZÁG	Electrolux Lehel Kft Tel: 00 36 1 251 41 47
NORGE	Flymo/Partner, div. av Electrolux Motor a.s. Tel: 69 10 47 90
NEDERLAND	Flymo Nederland Tel: 0172-468322, Fax: 0172-468219
ÖSTERREICH	Husqvarna-Ges.m.b.H. Nfg. KG, Industriezeile 36, 4010 LINZ, Tel: 0732 770101-0, Fax: 0732 770101-40, email: office@husqvarna.co.at Internet: www.husqvarna.at
POLSKA	Electrolux Poland Sp. z.o.o. Husqvarna, 01-612 Warszawa Myslowicka 10/2 Tel:- (22) 8332949
SLOVENIJA	Husqvarna-Ges.m.b.H. Nfg. KG, Industriezeile 36, 4010 LINZ, Tel: 0732 770101-0, Fax: 0732 770101-40, email: office@husqvarna.co.at Internet: www.husqvarna.at
SLOVENSKA	Electrolux Slovakia s.r.o., Borova Sihot 211, 033 01 Lipt. Hradok Tel: 044 522 14 19, Fax: 044 522 14 18, www.flymo-partner.sk
SCHWEIZ/SUISSE/SUIZZERA	Flymo Schweiz/Suisse/Suizzera Tel 062 889 93 50 / 889 94 25, Fax 062 889 93 60 / 889 94 35
SVERIGE	Electrolux Outdoor Products, Sverige Tel: 036 – 14 67 00, Fax: 036 – 14 60 70
UNITED KINGDOM	Electrolux Outdoor Products United Kingdom Tel: 01325 300303, Fax: 01325 310339

Electrolux Outdoor Products
Aycliffe Industrial Park
NEWTON AYCLIFFE
Co.Durham DL5 6UP
ENGLAND

Telephone - (00) 44 1325 300303 Fax - (00) 44 1325 310339

UK Telephone - 01325 300303 Fax - 01325 310339

Our policy of continuous improvement means that the specification of products may be altered from time to time without prior notice. Electrolux Outdoor Products manufacture products for a number of well known brands under various registered patents, designs and trademarks in several countries.

© Electrolux Outdoor Products Ltd. Registered Office, Electrolux Works, Oakley Road, Luton LU4 9QQ
Registered number 974979 England



The Electrolux Group. The world's No.1 choice.

The Electrolux Group is the world's largest producer of powered appliances for kitchen, cleaning and outdoor use. More than 55 million Electrolux Group products (such as refrigerators, cookers, washing machines, vacuum cleaners, chain saws and lawn mowers) are sold each year to a value of approx. USD 14 billion in more than 150 countries around the world.

