

CSE2040S, 967148201, 2014-05

SPARE PARTS LIST

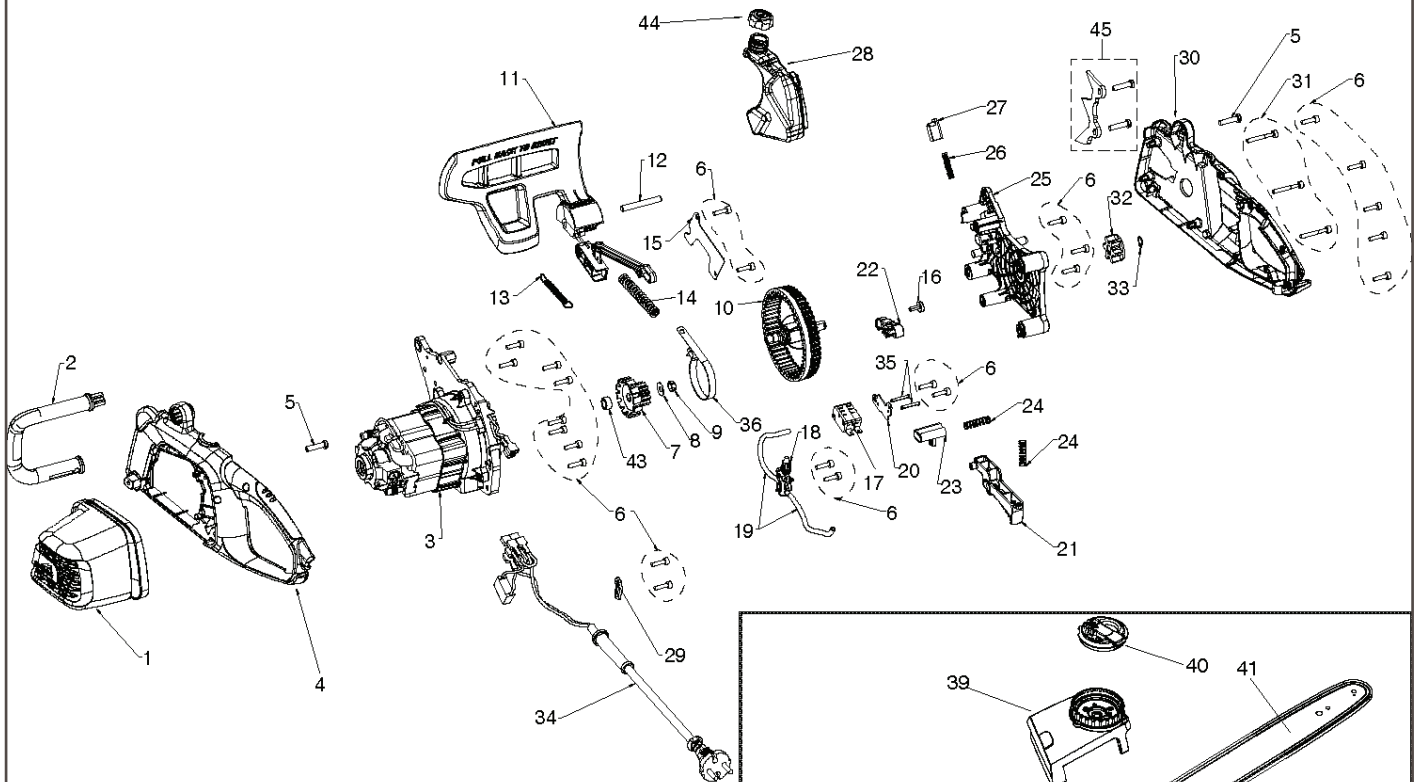

⚠ WARNING

All repairs, adjustments and maintenance not described in the Operator's Manual must be performed by Qualified Service Personnel.

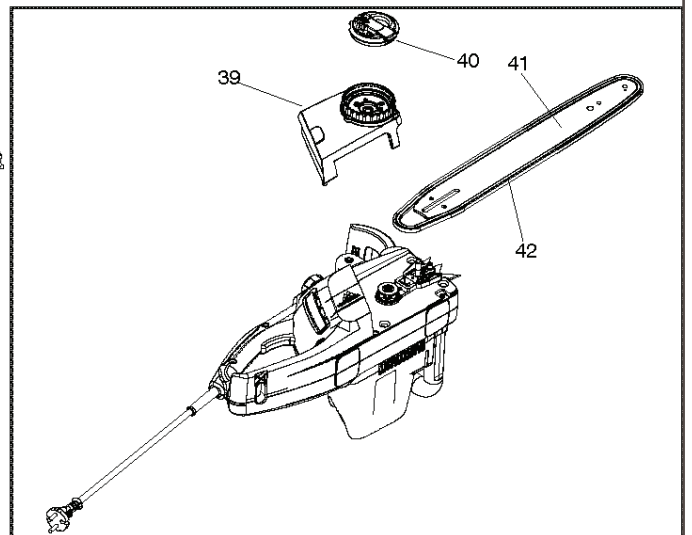

REF.	PART NO.	DESCRIPTION	REMARK	QTY.	KIT
1	581126701	MOTOR COVER		1	
2	581126901	FRONT HANDLE		1	
3	579044904	MOTOR ASSY		1	
4	581126601	HOUSING		1	
5	530016432	SCREW		2	
6	530016449	SCREW		24	
7	579043101	PINION		1	
8	586555801	DISC SPRING		1	
9	574594401	NUT		1	
10	579658801	GEAR ASSY		1	
11	579590001	LINK ASSY		1	
12	579045302	PEN		1	
13	579044301	SPRING		1	
14	579589801	SPRING		1	
15	579044801	PLATE		1	
16	579598601	SCREW		1	
17	586072201	MICRO SWITCH		1	
18	579043901	OIL PUMP		1	
19	579044101	OIL HOSE		2	
20	586073401	PLATE		1	
21	581132701	TRIGGER		1	
22	579044001	LEVER		1	
23	581132801	LOCKING BUTTON		1	
24	530042091	SPRING		2	
25	581006502	BEARING HOUSING ASSY		1	
26	545071201	SPRING. HANDGUARD POSITION		1	
27	580637501	CATCH		1	
28	580977802	TANK ASSY		1	
29	579715501	CORD BRACKET		1	
30	581126501	HOUSING		1	
31	530016448	SCREW		1	
32	579045701	SPROCKET		1	
33	530042090	RETAINER RING		1	
34	579663703	CORD		1	
35	586082401	PEN		1	
36	579044701	BRAKE BAND		1	
39	585638403	COVER		1	
40	577314401	ASSEMBLY		1	
41	577614331	BAR		1	
42	577615126	SAW CHAIN		1	
43	586628301	SPACER		1	
44	586873701	TANK CAP ASSY		1	
45	586873601	SPIKE		1	