



 **McCULLOCH**[®]
THE POWER TO GET IT DONE™

QUICK GUIDE



McCULLOCH Robotic Mower
ROB S600/S800



For more information and instructions, please read the complete supplied Operator's manual or visit www.mcculloch.com.
Installation support videos can be found on www.mcculloch.com.

1. To install the charging station

1. Attach the charging tower to the baseplate.
2. Place the charging station on a flat level surface where there is open space.
NOTE: To place the charging station in a limited space or in a corner, please read the Operator's manual.
3. Connect the low voltage cable to the charging station and the power supply.
4. If outdoor, put the power supply at a minimum height of 30 cm / 12 in from the ground.
5. Connect the power supply to a 100-240 V wall socket.
6. Place the robotic lawn mower in the charging station.
7. Push the **ON/OFF** button for 3 seconds to switch on the robotic lawn mower to charge the battery while the boundary wire is laid.
NOTE: Do not continue with any product settings before the installation is complete.

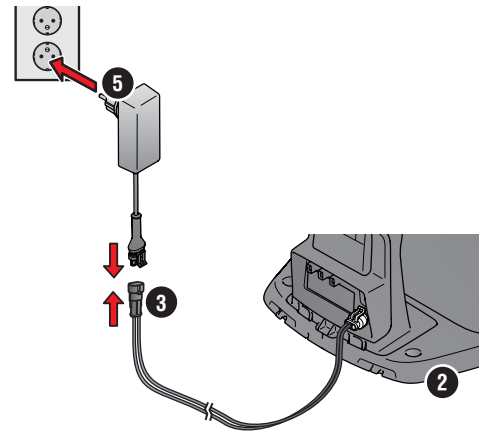

2. To install the boundary wire

1. Lay the boundary wire so that it forms a loop around the whole work area using stakes supplied or bury the wire.
NOTE: Do not lay the boundary wire in sharp bends.
2. Adapt the distance between the boundary wire and different objects.
A: Lay the boundary wire around all work area in a loop.
B: High obstacles > 5 cm / 2 in e.g. wall or fence.
C: Low obstacles 1-5 cm / 0.4-2 in. or a dropped edge e.g. flower bed.
D: Objects level with the lawn 0-1 cm / 0.4 in e.g. path, paving stones.
E: Make an island to isolate areas.
3. Make an eyelet at the point on the boundary wire where the guide wire is later connected (F).
4. To handle slopes, passages and secondary areas, refer to the Operator's manual.

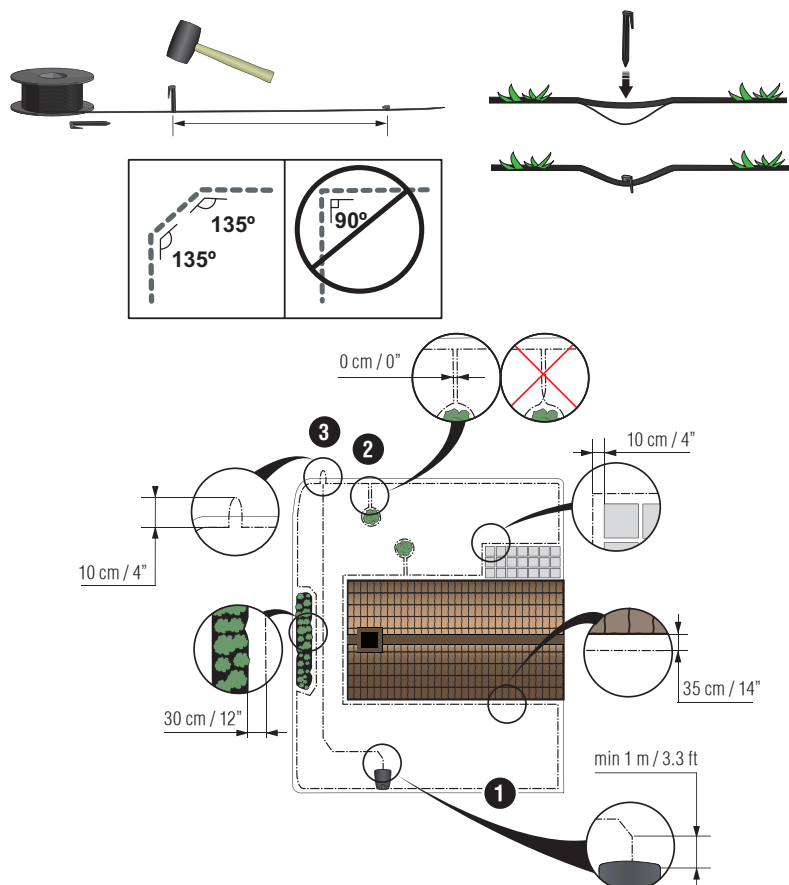

1. STOP button
2. LED for function check of the charging station, boundary and guide wires
3. Charging station
4. Display
5. Keypad
6. ON/OFF button

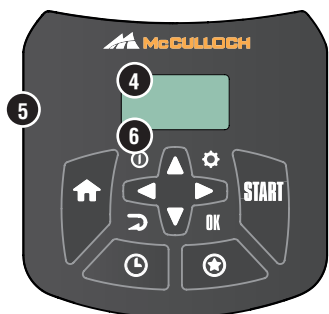
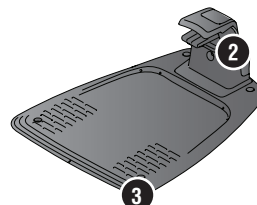

3. To connect the boundary wire

1. Open the connector and lay the boundary wire in the connector.
2. Press the connector and the wire together by using a pair of pliers.
3. Cut off the wire 1-2 cm / 0.4-0.8 in. after the connectors.
4. Press the boundary wire connectors onto the contact pins marked L (left) and R (right) on the charging station.

NOTE: The right-hand wire must be connected to the right-hand contact pin on the charging station, and the left-hand wire to the left-hand pin.

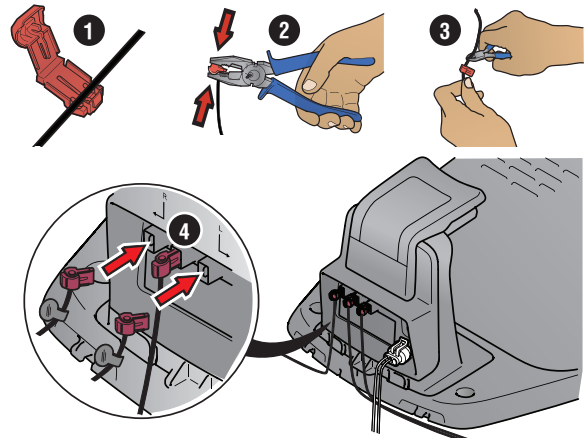

4. To install and connect the guide wire

Install a guide wire to lead the robotic lawn mower to remote parts of the lawn and to help it to find the charging station.

1. Push the guide wire through the bottom of the charging station and fasten it into place using the snap locks.
2. Fit the connector to the guide wire in the same way as for the boundary wire, according to the instructions above.
3. Press the guide wire connector onto the contact pin marked GUIDE on the charging station.
4. Pull the guide wire a minimum of 1 m / 3.3 ft. straight out from the front edge of the charging station.
5. Lay the guide wire from the charging station to the point on the boundary wire (eyelet) where the connection is made using stakes supplied or bury the wire.
6. Cut the boundary wire at the center of the eyelet that was made in step 2.3.
7. Connect the guide wire to the boundary wire by inserting the boundary wires and guide wire in the coupler, and pressing the coupler together with a pair of pliers.

NOTE: Do not lay the guide wire in sharp bends and it cannot cross the boundary wire that for instance is laid out for an island.

NOTE: After the guide wire is installed, attach the charging station to the ground with the supplied screws and allen key.

NOTE: For optimal performance through narrow passages please ensure the guide wire is laid correctly through it. Please read the Operator's manual for further instructions.

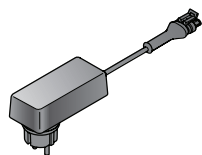
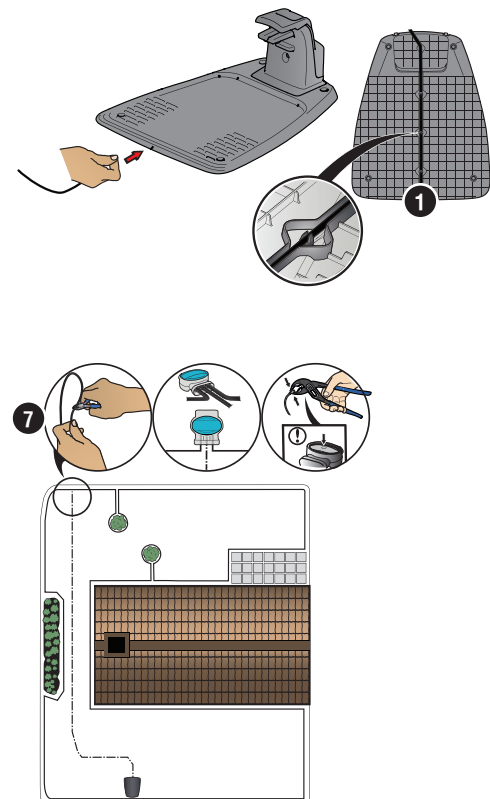

Power supply
(the appearance of the power supply may differ depending on market)



Low voltage cable

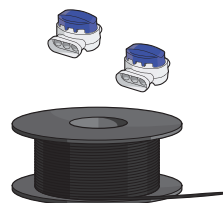

Boundary wire and couplers



Stakes/Pegs

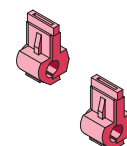

Connectors



Measurement gauge

5. To start and stop the robotic lawn mower

When starting the robotic lawn mower for the first time a start-up sequence begins where you choose your language, country, date, time and personal PIN code. There is also a guide calibration, where the robotic lawn mower automatically follow the guide wire. Read the Operator's manual for more information.

To start the robotic lawn mower

1. Open the hatch to the keypad.
2. Push the **ON/OFF** button for 3 seconds. The display is lit up.
3. Enter the PIN code by using the up/down **arrow** buttons, and push the **OK** button.

To stop the robotic lawn mower

1. Push the **STOP** button.

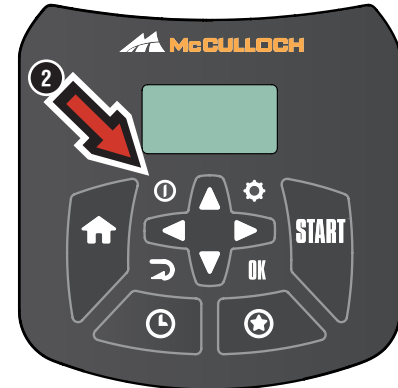

6. To change the settings

All settings for the robotic lawn mower are done via the menu functions. Please read the Operator's manual and become familiar with the menus and settings.

1. The *Schedule* function is used to adjust the mowing time to suit your work area. If the robotic lawn mower is allowed to mow too often, the grass may appear flattened. Use the scheduling wizard to set a suitable schedule. Push the **Schedule** button and select *Wizard* and enter the size of your work area. If you want to change the schedule settings for individual days use *Schedule > Advanced*.
2. Use the **STAR** button to select operating mode, for example *Secondary area*, *Power cut* or *Spot cut*.
3. Use the **HOME** button to select the park mode *Home & Stay* or *Home & Wait*.
4. Use the **START** button to begin the operation of the lawn mower.

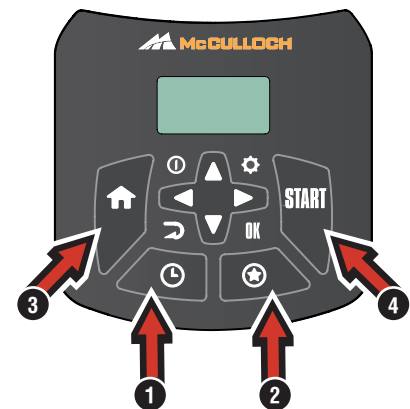

Test run the robotic lawn mower through narrow passages

Narrow passages in the garden can make it difficult for the mower to find the charging station. Use the *Test* function to test that the robotic lawn mower can travel through the narrow passage.

1. Place the robotic lawn mower in the charging station.
2. Select *Test* in the menu (*Settings > Installation > Lawn coverage > More > Test*) and push **OK**. Then push the **Start** button and close the hatch.
3. Check that the robotic lawn mower follows the guide wire through the passage.
 - a. If the robotic lawn mower runs through the passage, the test is complete.
 - b. If the robotic lawn mower does not get through the passage: Check that the guide wire has been laid according to the instructions in the Operator's manual.

