

ILLUSTRATED PARTS LIST

MODEL NO. 96021003600

CUSTOMER CATALOG NO. M110-77X

PRODUCT NO. 960 21 00-36

**RIDING MOWER -- MODEL NO. M110-77X (96021003600), PRODUCT NO. 96021 00-36
DECALS 27**

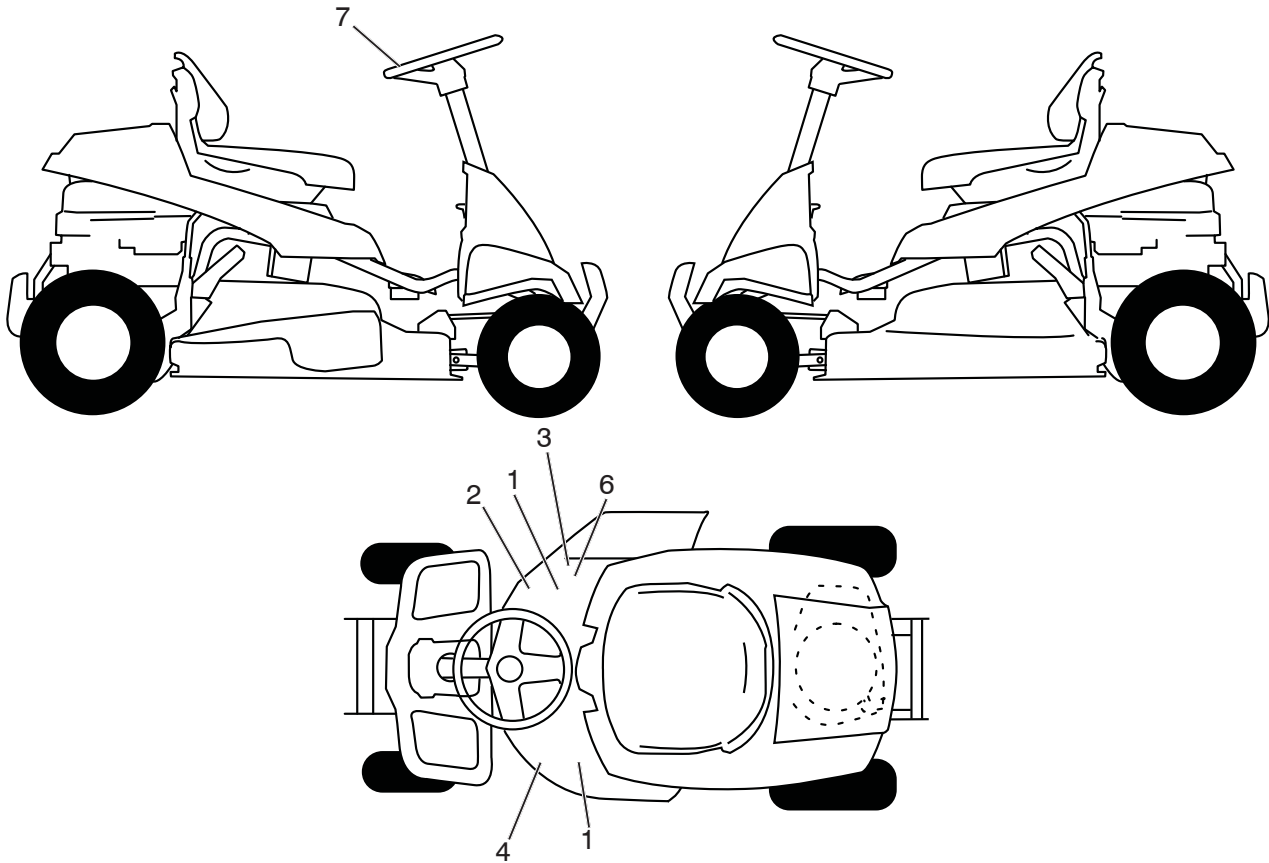

KEY NO.	PART NO.	DESCRIPTION
1	581 72 43-01	DECAL, NO STEP
2	532 44 14-97	DECAL, V-BELT SCH
3	581 57 93-01	DECAL, WARN. DEFLECT/CTFGR
4	591 15 35-01	DECAL, DECK/DEFLECT
6	584 90 46-01	DECAL, DEFLECTOR WARNING
7	501 49 43-01	DECAL, STEERING WHEEL
--	115 91 00-20	MANUAL OPER.MCC.EURO
--	115 91 02-10	MANUAL OPER.MCC.SCAN
--	115 91 01-50	MANUAL OPER.MCC.EBLOC
--	115 91 03-40	MANUAL OPER.MCC.BALTIC

NOTE: All component dimensions given in U.S. inches
1 inch = 25.4 mm

RIDING MOWER-- MODEL NO. M110-77X (96021003600), PRODUCT NO. 960 21 00-36 SCHEMATIC **38**

SCH24

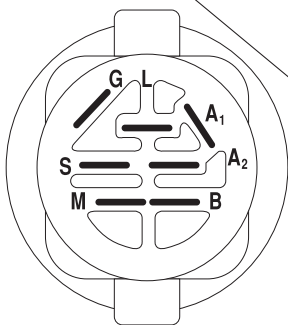
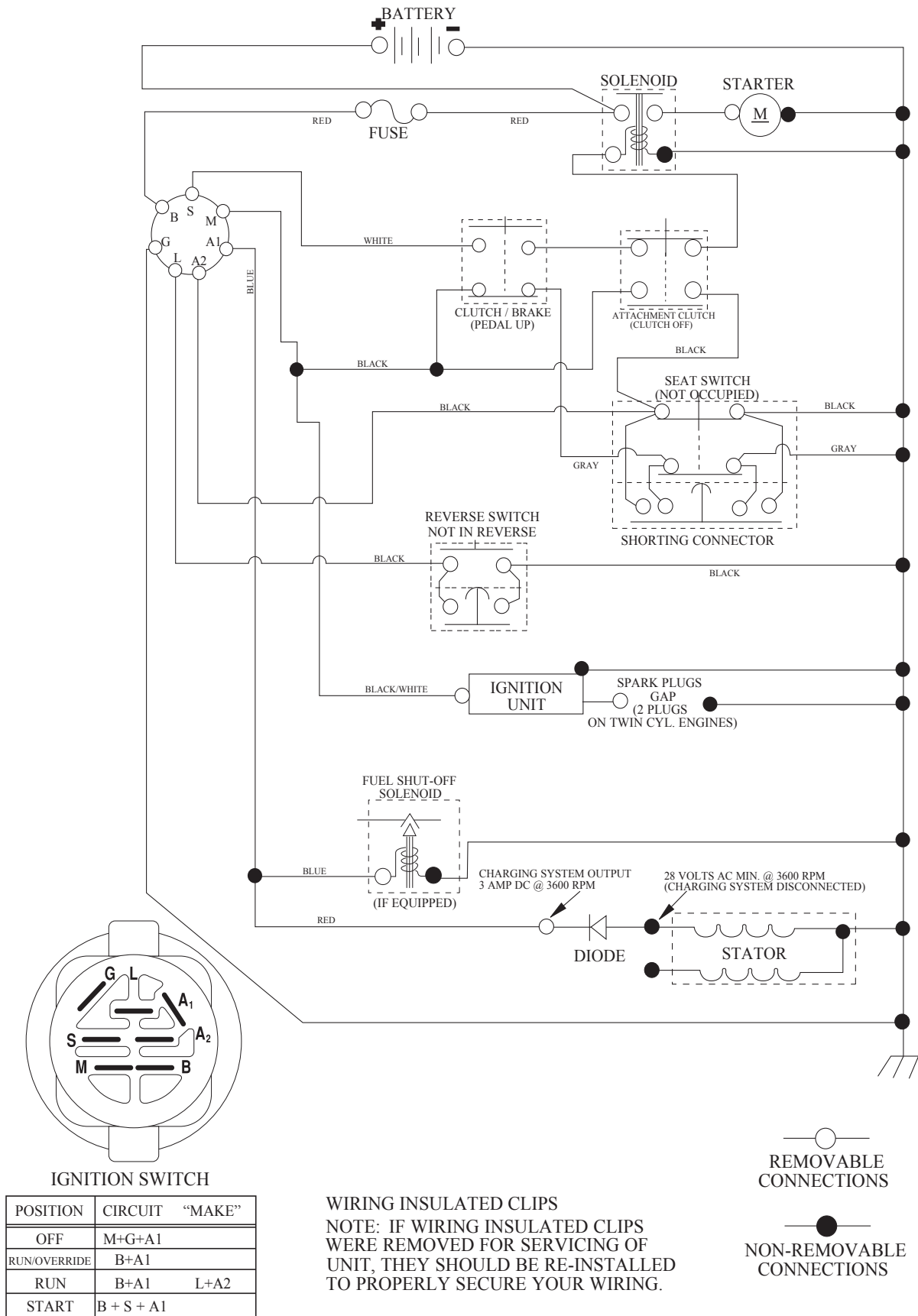

IGNITION SWITCH

POSITION	CIRCUIT "MAKE"
OFF	M+G+A1
RUN/OVERRIDE	B+A1
RUN	B+A1 L+A2
START	B + S + A1

WIRING INSULATED CLIPS
NOTE: IF WIRING INSULATED CLIPS WERE REMOVED FOR SERVICING OF UNIT, THEY SHOULD BE RE-INSTALLED TO PROPERLY SECURE YOUR WIRING.

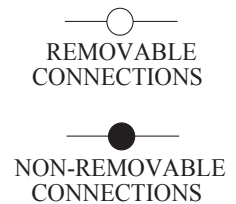

RIDING MOWER -- MODEL NO. M110-77X (96021003600), PRODUCT NO. 96021 00-36
ELECTRICAL 32

LRV3

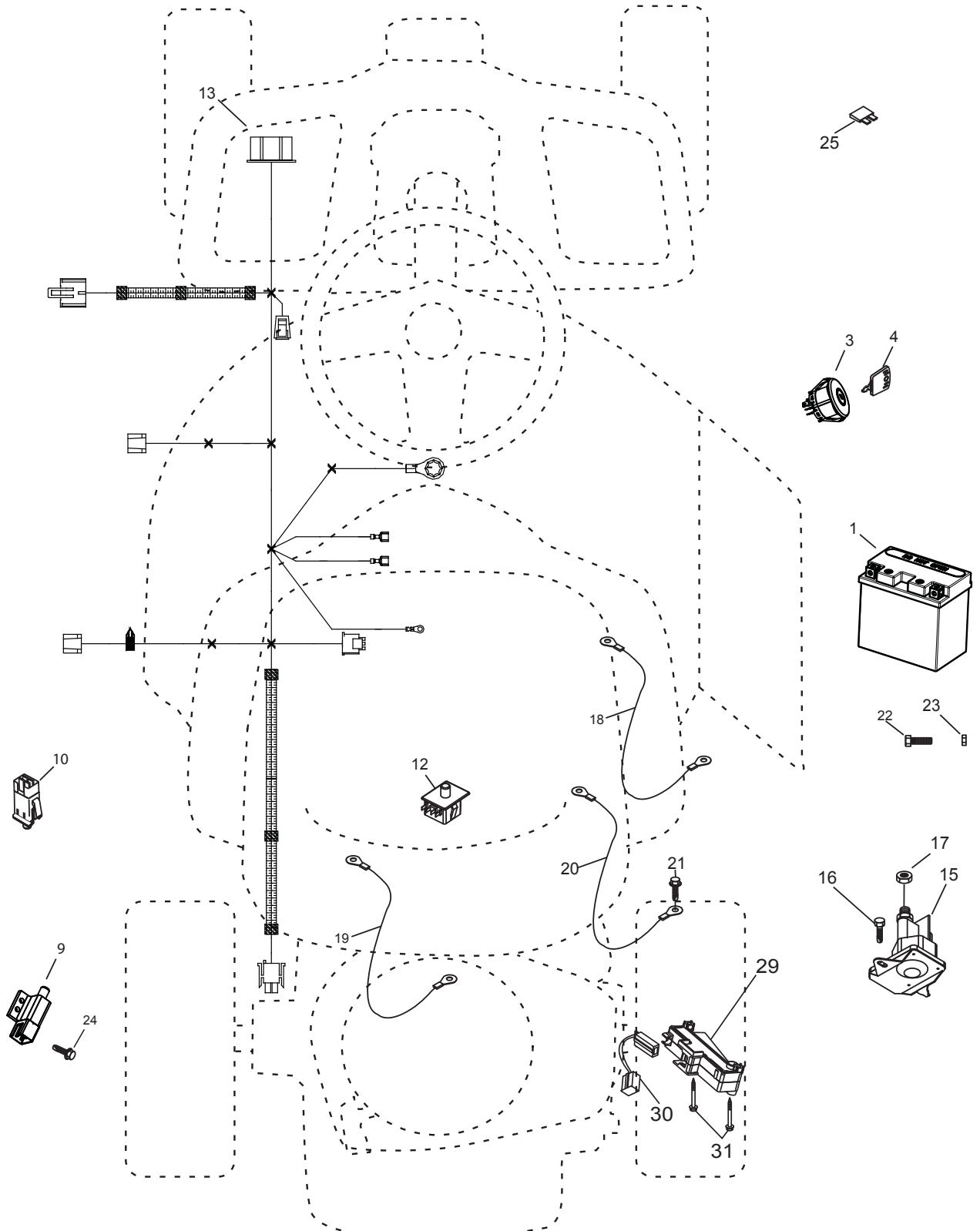

**RIDING MOWER--MODEL NO. M110-77X (96021003600), PRODUCT NO. 960 21 00-36
ELECTRICAL **32****

KEY PART NO.	PART NO.	DESCRIPTION
1	532 43 65-51	BATTERY
3	532 19 33-50	SWITCH, IGN, DLTA, P-IN, ROS
4	532 41 19-35	KEY/CHAIN
9	532 10 95-53	SWITCH, INTLK,CL, MWR, GRY
10	532 17 61-38	SWITCH, INTERLOCK, NONC,GRAY
12	532 19 27-49	SWITCH, SEAT, DP, ROS
13	584 29 96-01	HARNESS, IGN, ELECTSTART, LRV
15	582 04 28-01	SOLENOID
16	817 00 05-12	SCREW 5/16-18 3/4 SMGML TAP
17	873 51 04-00	NUT KEPS HEX 1/4-20 UNC
18	532 42 16-86	CABLE GROUND RET BATT
19	532 42 12-99	CABLE STARTER
20	532 42 12-98	CABLE GROUND
21	817 06 05-12	SCREW 5/16-18 X 3/4
22	532 44 21-48	SCREW HEX M5X0.8.9MM
23	532 43 81-22	NUT M5
24	574 82 27-01	SCREW #10-24 X .75
25	532 43 48-99	FUSE, 10
29	532 19 18-34	MODULE REVERSE
30	581 62 52-01	JUMPER PIGTAIL
31	532 19 25-40	SCREW PLASTIC

NOTE: All component dimensions given in U.S. inches
1 inch = 25.4 mm

RIDING MOWER -- MODEL NO. M110-77X (96021003600), PRODUCT NO. 96021 00-36
CHASSIS AND ENCLOSURES **39**

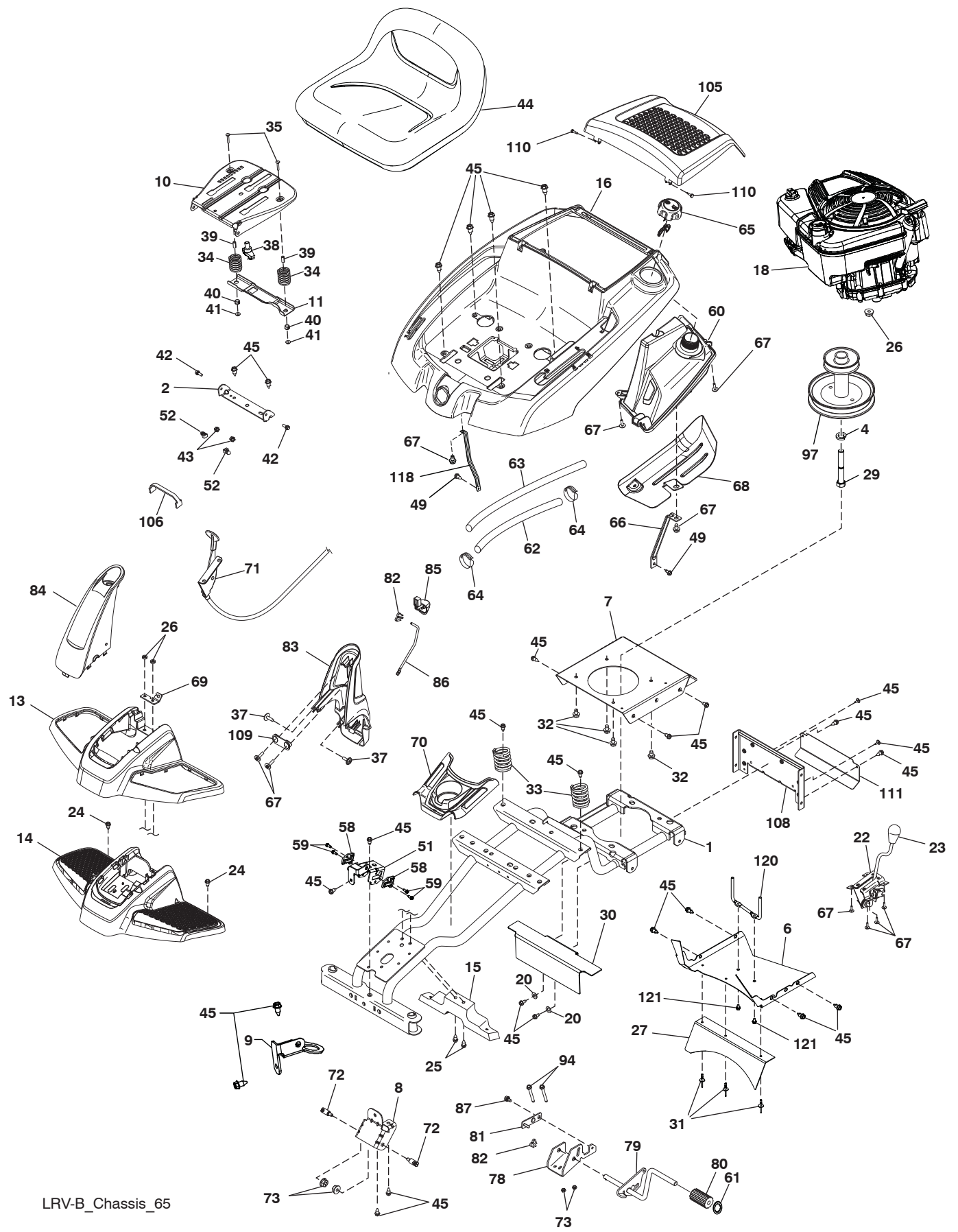

LRV-B_Chassis_65

**RIDING MOWER-- MODEL NO. M110-77X (96021003600), PRODUCT NO. 960 21 00-36
CHASSIS AND ENCLOSURES 39**

KEY NO.	PART NO.	DESCRIPTION	KEY NO.	PART NO.	DESCRIPTION
1	532 43 61-76	WELDMENT, CHASSIS	58	588 45 25-01	BUSHING RACK LRVB
2	532 18 01-66	BRACKET, SEAT	59	532 13 77-29	SCREW THD ROLL 1/4-20 X 5/8
4	539 99 02-47	WASHER SLW 7/16	60	532 43 78-02	FUEL TANK ASM
6	584 82 32-02	PAN, BELLY, GUARD	61	587 01 57-02	NUT PUSH
7	532 43 61-77	PLATE, ENGINE	62	532 40 04-14	FUEL LINE
8	587 58 18-01	BRACKET, CHASSIS FRONT	63	532 41 41-19	PURGE LINE
9	587 30 50-02	STEERING SUPPORT BRACKET	64	532 12 34-87	CLAMP HOSE
10	532 44 18-05	PAN, SEAT	65	581 17 61-01	FUEL CAP
11	532 19 93-70	BRACKET, SWITCH MOUNTING	66	532 43 66-06	FUEL TANK SUPPORT BRKT
13	532 44 20-71	COVER, FOOT REST	67	532 42 17-56	SCREW #10 X 0.500
14	532 44 20-75	FOOTREST STRUCTURAL	68	532 43 98-51	SHIELD HEAT
15	532 44 20-69	SUPPORT, FOOT REST	69	532 43 74-27	BRACKET MOUNT CABLE
16	584 97 69-13	PANEL CONTROL ASM	70	532 44 20-68	CONSOLE CENTER CUPHOLDER
18	---	ENGINE MCCULLOCH, LLC 352 (591070901)	71	532 43 78-57	THROTTLE ASM
20	819 11 12-16	WASHER 11/32 X 3/4 X 16	72	532 19 51-61	STUD FASTNER
22	586 04 19-01	DECK CLUTCH ASM	73	873 90 05-00	NUT LOCK FLANGE 5/16-18
23	532 14 98-46	KNOB	78	532 43 70-56	BRACKET SUPPORT ROD
24	532 41 63-58	SCREW #10 X 0.750	79	532 43 70-57	BRAKE WELDMENT
25	872 14 04-24	BOLT	80	532 42 96-93	BRAKE PEDAL COVER
26	593 35 64-01	NUT FLANGE M6 SERRATED	81	532 43 73-74	WELDMENT LINK CONNECTING
27	584 82 34-01	GUARD, PAN EXTENSION PLASTIC	82	532 16 94-84	RETAINER CLIP
29	501 60 69-01	BOLT HEX 7/16-20 X 3 GR.5	83	587 68 64-03	COLUMN REAR STERRING ASM
30	585 92 69-01	ENG. PLATE EXTENSION	84	587 38 86-07	STEERING BOOT FRONT
31	532 14 08-11	RIVET	85	532 43 76-60	PARKING BRAKE HANDLE
32	817 12 06-16	SCREW 3/8-16 X 1 SMGL TAP	86	532 43 87-62	ACTUATOR PARKING BRAKE
33	587 61 33-01	SPRING, SEAT	87	532 16 54-92	SHOULDER BOLT
34	532 12 37-40	SPRING	94	874 49 05-48	BOLT
35	872 05 04-12	BOLT, 1/4-20 X 1 1/2	97	581 43 80-01	PULLEY ENGINE
37	532 14 18-41	SCREW 10-16 x .65	105	532 44 79-92	ENGINE COVER
38	532 19 93-72	KNOB SEAT	106	532 43 68-34	STRAP BATTERY
39	532 13 43-00	SPACER	108	532 43 71-68	COVER REAR TRANSAXLE
40	532 12 12-48	BUSHING, NYLON SNAP	109	532 43 90-08	BRAKE HANDLE PLATE
41	532 12 39-76	NUT, LOCK	110	532 44 21-45	CONTROL PANEL HINGE PIN
42	587 90 78-01	BOLT, 5/16-18 X 5/8 SHOULDER	111	532 43 81-71	SHIELD CABLE, BRAKE
43	873 80 05-00	NUT, 5/16-18	118	532 44 50-02	SUPPORT CONTROL PANEL RH
44	581 46 20-01	SEAT	120	588 06 46-02	BELT KEEPER ENGINE
45	817 00 05-12	BOLT, 5/16-18 X 3/4	121	817 60 04-06	SCREW 1/4-20 X 3/8
49	817 06 05-16	SCREW			
51	585 92 03-02	BRACKET STEERING			
52	532 14 50-06	CLIP PUSH-IN HINGED			

NOTE: All component dimensions given in U.S. inches
1 inch = 25.4 mm

RIDING MOWER -- MODEL NO. M110-77X (96021003600), PRODUCT NO. 96021 00-36
DRIVE **40**

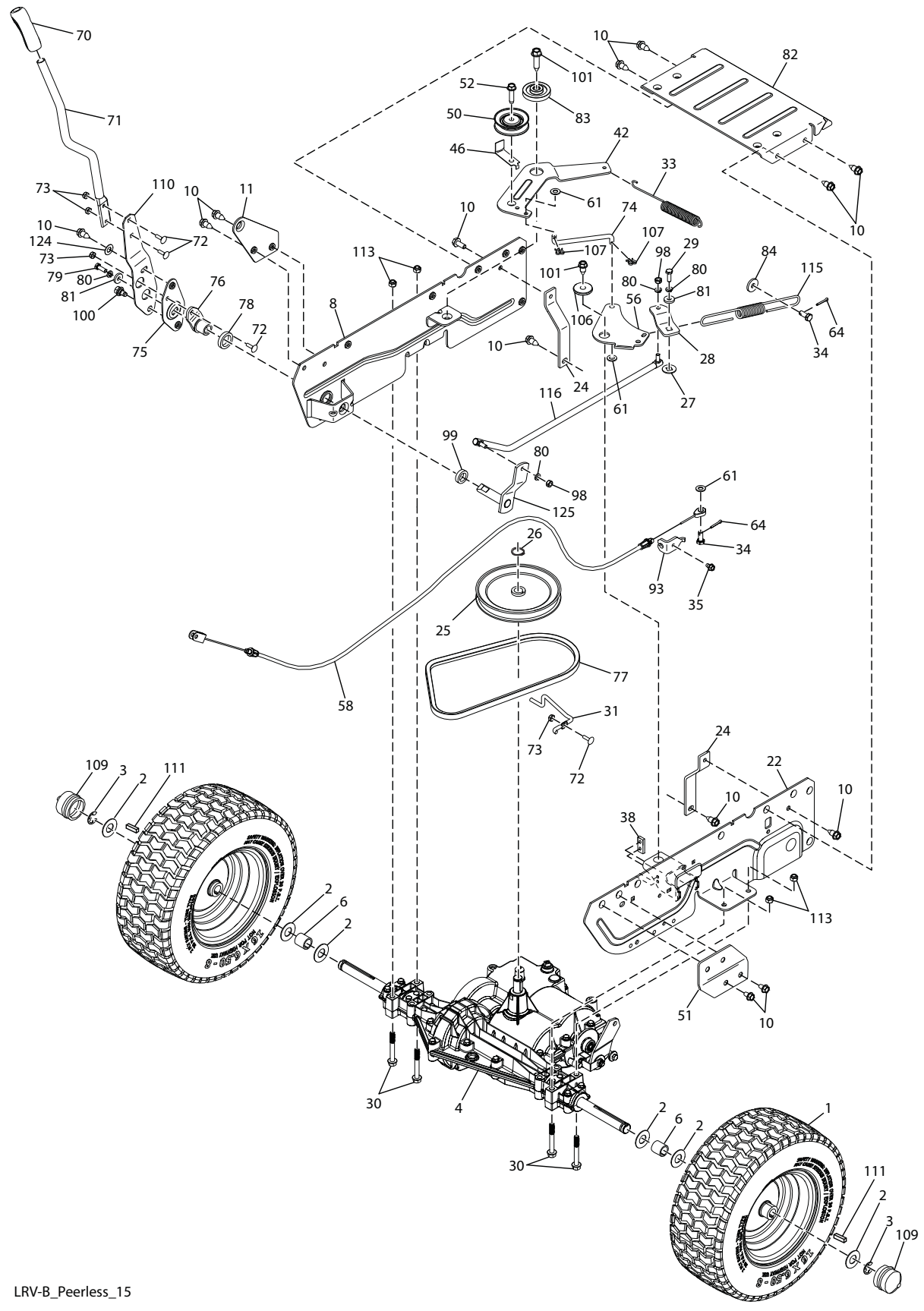

LRV-B_Peerless_15

**RIDING MOWER-- MODEL NO. M110-77X (96021003600), PRODUCT NO. 960 21 00-36
DRIVE 40**

KEY NO.	PART NO.	DESCRIPTION	KEY NO.	PART NO.	DESCRIPTION
1	532 44 20-79	WHEEL ASM (REAR)	74	580 96 12-01	LINK CLUTCHING
2	532 12 17-48	WASHER, 16 GA.	75	532 42 84-64	BRACKET MOUNT SHIFT
3	812 00 00-01	E-CLIP	76	532 44 43-04	HUB SHIFT
4	584 83 63-01	TRANSMISSION	77	581 60 59-01	BELT, DRIVE GOUND
6	532 15 69-72	SPACER AXLE	78	532 42 90-55	SPACER NYLON .866X1.25X.250
8	581 52 47-02	WELDMENT.SIDEPLATE.RH	79	874 78 04-12	BOLT, HEX.1/4-20 UNC X .75
10	817 00 05-12	SCREW 5/16 - 18 X 3/4	80	810 04 04-00	WASHER LOCKH VYHLCLSPRING
11	532 43 67-41	BRACKET.SUPPORT.RH	81	819 09 12-10	WASHER 9/32 X 3/4 X 10 GA.
22	581 52 46-02	WELDMENT.SIDEPLATE.LH	82	581 52 52-02	COVER, REAR
24	580 96 08-02	STRAP.TORQUE	83	532 19 43-21	SPACER RETAINER
25	581 43 77-01	PULLEY.INPUT	84	819 11 16-10	WASHER
26	812 00 00-28	RING RETAINER	93	532 42 80-70	BRAKE MOUNT
27	532 10 57-01	WASHER PLATE	98	532 15 03-60	NUT LOCK CENTER 1/4-28
28	580 94 93-02	ARM, SHIFTER	99	581 04 92-01	SPACER.ARM SHIFTER
29	874 55 04-12	BOLT.1/4-28	100	532 16 54-92	BOLT,SHOULDER 5/16-18X .561
30	874 49 05-40	BOLT.HXFLGHD.5/16-18X2.1/5 G5	101	817 06 06-24	SCREW, 3/8-16X1-1/2 SMGML. TAP/R
31	581 43 81-02	KEEPER.BELT.DRIVE	106	532 19 90-92	SPACER RETAINER
33	581 59 31-01	SPRING ADJUSTER TENSION	107	532 17 80-62	CLIP
34	581 52 50-01	PIN, CROSSDRILLED	109	532 19 32-68	CAP, HUB AXLE 1.50 X 1.00
35	817 49 04-06	SCREW.1/4-20X3/8	110	532 42 84-61	BRACKET SHIFTER FLEX
38	581 22 30-01	PLATE.NUT	111	532 12 35-83	KEY, SQUARE
42	580 96 13-02	ARM, CLUTCHING	113	873 90 05-00	NUT LOCK HEX FLANGE 5/16-18
46	581 44 42-02	KEEPER.BELT CLUTCHING	115	581 49 38-01	SPRING BRAKE
50	532 19 95-34	PULLEY V-IDLER	116	580 94 92-01	SUBASM, LINK
51	532 43 67-39	BRACKET SUPPORT LH	124	532-16 60-02	WASHER, SRRTD 5/16IDX 1.0 X125TK
52	817 58 05-20	SCREW, THDRL	125	580 94 98-02	SHAFT, SHIFT, GEARDRIVE
56	581 44 40-02	BELLCRANK			
58	581 53 16-01	CABLE, BRAKE			
61	819 11 11-16	WASHER			
64	876 02 04-12	PIN, COTTER			
70	580 96 23-01	GRIP HANLDE LIFT			
71	532 43 68-65	TUBE SHIFT LRV			
72	539 11 56-20	BOLT, CARRAIGE.1/4-20 X 3/4			
73	873 68 04-00	NUT CROWNLOCK 1/4 - 20 UNC			

NOTE: All component dimensions given in U.S. inches
1 inch = 25.4 mm

RIDING MOWER -- MODEL NO. M110-77X (96021003600), PRODUCT NO. 96021 00-36
 STEERING ASSEMBLY **41**

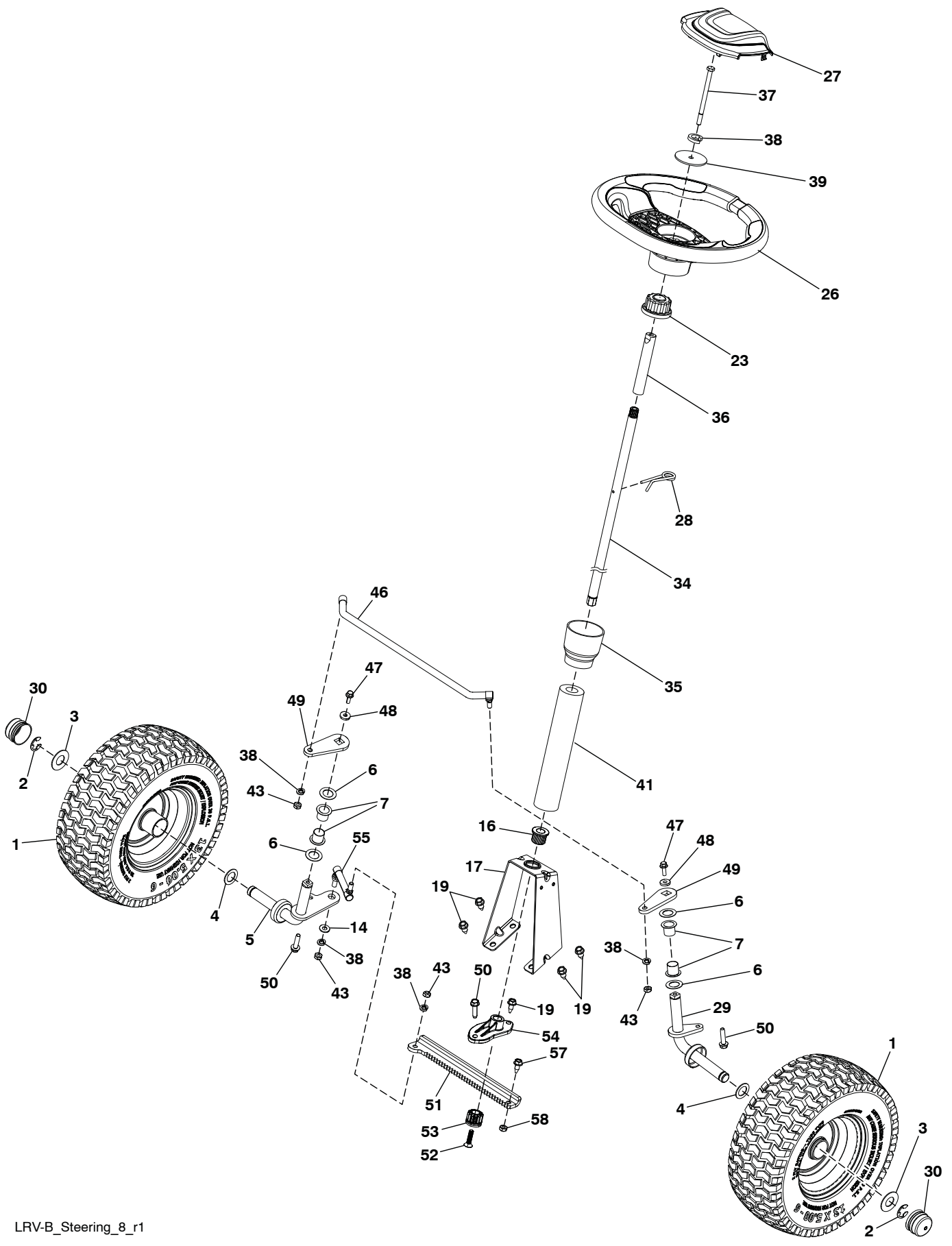

**RIDING MOWER-- MODEL NO. M110-77X (96021003600), PRODUCT NO. 960 21 00-36
STEERING ASSEMBLY **41****

KEY PART NO.	PART NO.	DESCRIPTION
1	532 44 20-64	WHEEL TUBE
2	812 00 00-01	E-CLIP
3	532 18 89-67	WASHER, HARDENED
4	532 12 17-49	WASHER, 1/4 X 3/4
5	588 07 84-02	SPINDLE, RH
6	532 12 49-31	WASHER, HARDENED THRUST
7	532 12 49-37	BEARING, STEERING COLUMN
14	819 11 11-16	WASHER 11/32 X 11/16 X 16 GA.
16	585 92 06-01	BEARING FLANGED
17	532 43 61-78	SUPPORT, UPPER STEERING
19	817 00 05-12	BOLT, 5/16-18 X 3/4
23	532 43 77-47	ADAPTER, STEERING WHEEL
26	532 42 45-43	WHEEL, STEERING
27	532 42 46-91	CAP, STEERING WHEEL
28	532 19 98-49	CLIP, RETAINER SPRING
29	588 07 85-02	SPINDLE, LH
30	532 19 32-68	CAP, HUB, AXLE
34	587 23 69-02	SHAFT STEERING UPPER
35	532 44 20-66	BOOT LOWER STEERING WHEEL
36	532 44 49-81	SHAFT EXTENSION STEERING SPLINE
37	747 80 51-04	HEX HEAD SCREW 5/16-18 X 6.5
38	539 99 01-87	WASHER LOCK
39	819 11 38-12	WASHER
41	532 43 65-90	FOAM SHAFT STEERING
43	873 54 05-00	CROWNLOCK NUT 5/16-24 UNF
46	587 46 35-01	LINK STEERING FRONT
47	589 02 85-01	SCREW FLG. LOCKING 1/4-20 X .75
48	819 09 12-10	WASHER 9/32 X 3/4 X 1.0
49	588 07 83-02	ARM STEERING UPPER
50	587 59 21-01	SCREW THDROL 5/16-18 X 1.25
51	585 92 01-02	STEERING RACK
52	580 68 36-01	SCREW HEAD SOCKET
53	580 68 37-01	PINION SHAFT STEERING
54	585 92 02-01	SUPPORT BUSHING STEERING
55	585 92 05-01	DRAG LINK RH
57	874 49 05-12	BOLT 5/16-18 X 3/4
58	873 90 05-00	NUT LOCK HEX FLANGE

NOTE: All component dimensions given in U.S. inches
1 inch = 25.4 mm

RIDING MOWER -- MODEL NO. M110-77X (96021003600), PRODUCT NO. 96021 00-36
MOWER DECK **44**

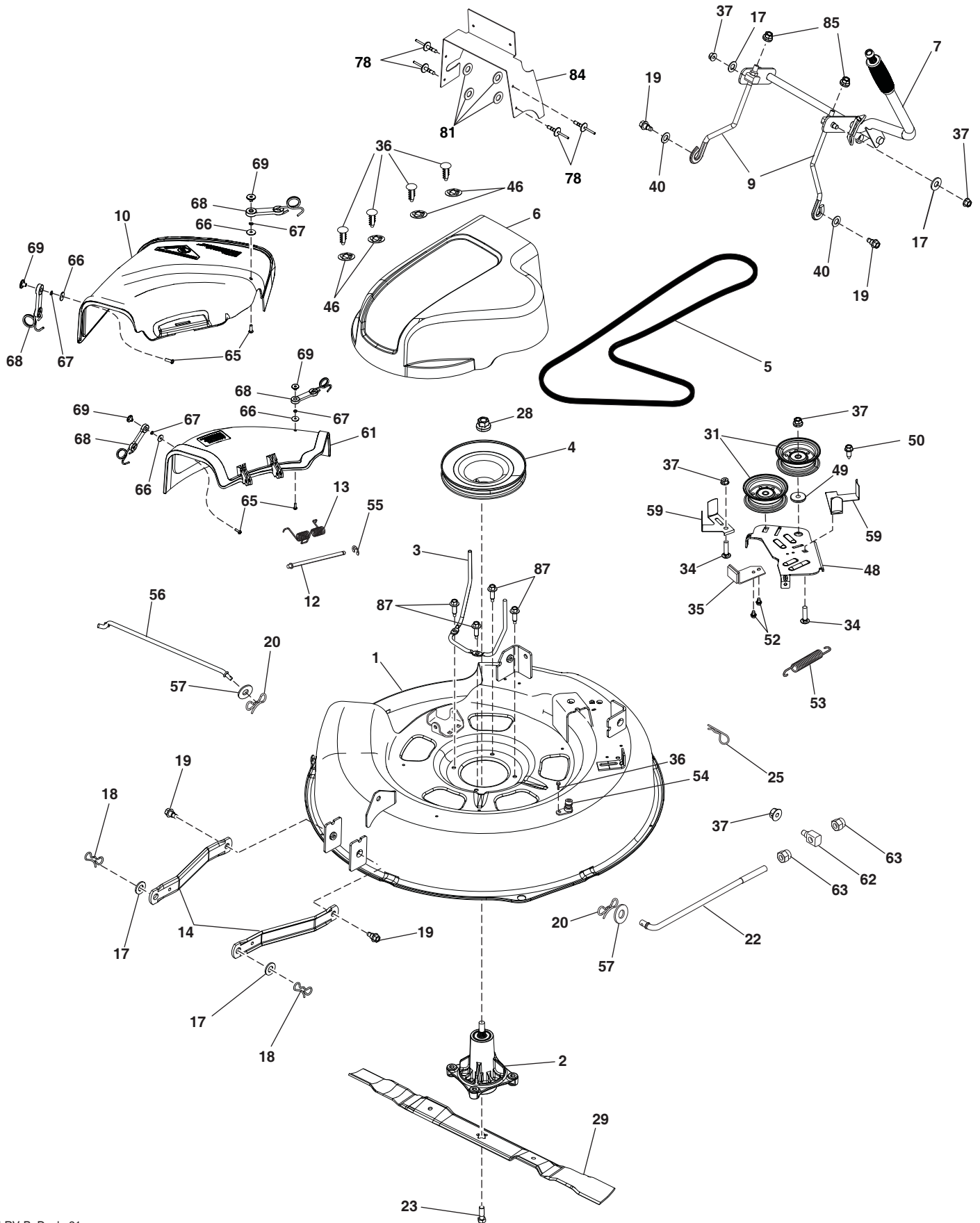

**RIDING MOWER-- MODEL NO. M110-77X (96021003600), PRODUCT NO. 960 21 00-36
MOWER DECK 44**

KEY PART NO.	PART NO.	DESCRIPTION
1	584 46 83-02	DECK
2	587 25 33-01	MANDREL ASM
3	584 44 45-02	KEEPER, BELT
4	584 44 44-02	PULLEY, MANDREL
5	584 29 37-01	BELT
6	532 44 50-24	COVER, MANDREL
7	586 58 09-01	LIFT ASM, DECK
9	582 34 27-01	LINK. ASM LIFT ADJUSTABLE
10	532 43 64-56	DEFLECTOR; 30" LRVB
12	532 43 66-47	PIN, HINGE
13	532 43 74-62	SPRING, TORSION
14	587 58 17-02	FRONT DECK LINK
17	819 19 19-12	WASHER
18	532 19 42-09	PIN
19	532 19 65-39	BOLT, SHOULDER
20	532 19 42-08	PIN COTTER 5/16 BOW TIE LOCK
22	584 97 75-03	LINK ASM DECK
23	584 30 93-01	SCREW SEMS 7/16-20 X 1 HEX
25	532 12 47-88	RETAINER SPRING 1"
28	532 40 02-34	NUT FLANGE LOCK TOP
29	532 41 92-73	BLADE
31	532 19 31-97	PULLEY, IDLER
34	872 11 06-12	BOLT, 3/8-16 X 1 1/2
35	532 19 94-77	ARM, BRAKE
36	532 13 77-29	SCREW THD ROLL 1/4-20 X 5/8
37	873 90 06-00	NUT, 3/8-16 FLANGE
40	819 17 16-16	WASHER, 16 GA.
46	532 42 30-62	PALNUT
48	586 84 36-01	ARM CLUTCHING
49	532 19 90-92	SPACER RETAINER
50	817 00 06-16	SCREW 3/8-16 X 1
52	817 60 04-06	SCREW 1/4-20 X 3/8
53	585 04 91-01	SPRING RETURN DECK
54	532 41 55-98	PORT WAHSOUT
55	532 43 79-88	E-RING 5/16
56	532 40 48-51	ROD ANTI-SWAY
57	819 13 13-12	WASHER 13/32 X 13/16 X 12 GA
59	532 43 68-58	GUARD TUV IDLER
61	532 43 64-55	COVER MULCH 30 INCH
62	532 17 62-05	TRUNION SUSPENSION ARM
63	532 17 59-94	NUT LIFT LINK 7/16-20
65	871 08 10-10	SCREW PAN HEAD 10-24 x 5/8
66	819 06 12-16	WASHER FLAT #10
67	810 07 10-00	LOCKWASHER
68	532 16 07-93	LATCH SUB ASSEMBLY
69	532 00 20-29	WELDNUT 10-24
78	532 14 08-11	RIVET
81	532 14 08-10	WASHER .194 X .625 X .060
84	584 82 33-02	GUARD MANDREL EXTENSION
85	873 35 06-00	NUT HEX JAM 3/8-16 UNC
87	584 95 39-01	BOLT, HEX, WASHER

NOTE: All component dimensions given in U.S. inches
1 inch = 25.4 mm

TRACTOR - - MODEL NO. M110-77X (96021003600), PRODUCT NO. 960 21 00-36
MCCULLOCH ENGINE (352 CC)

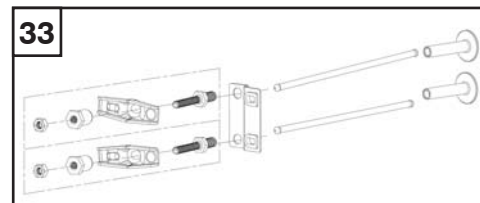
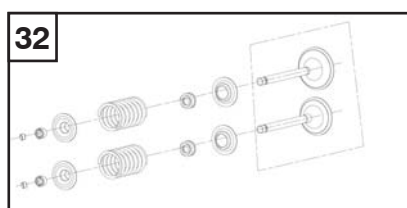
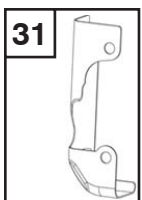
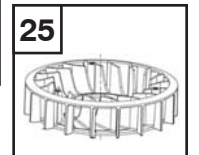
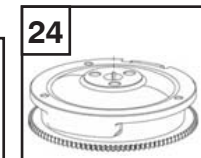
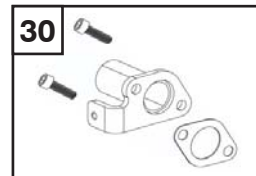
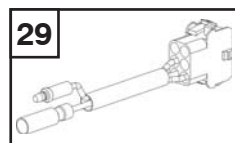
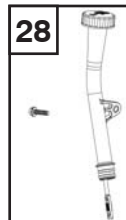
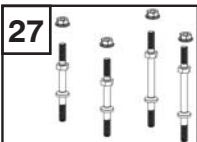
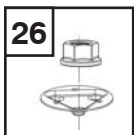
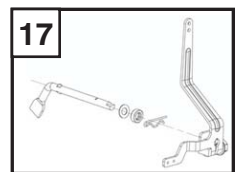
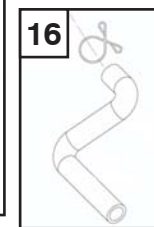
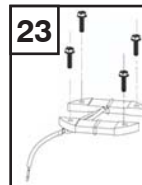
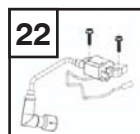
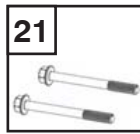
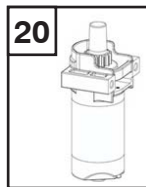
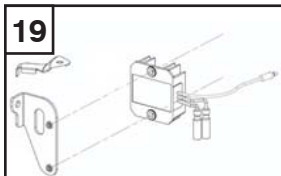
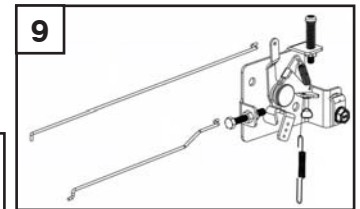
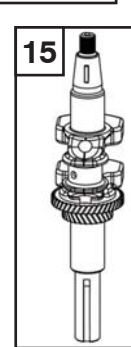
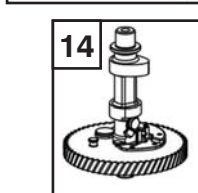
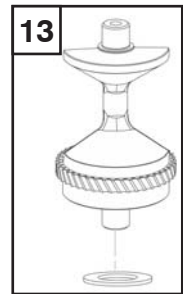
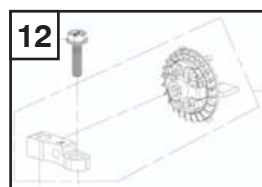
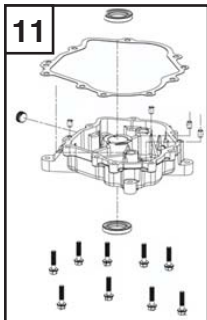
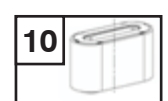
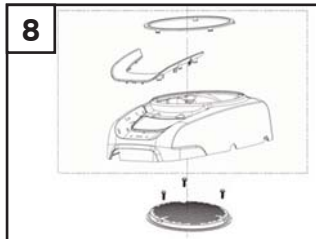
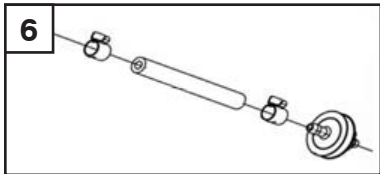
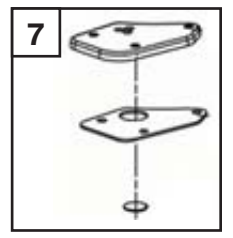
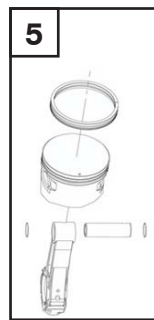
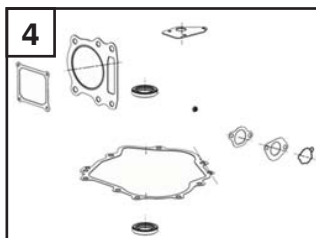
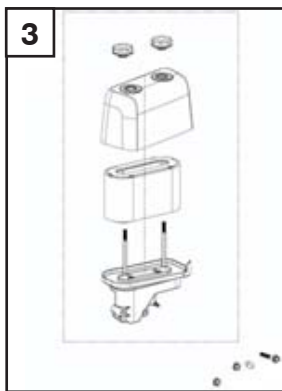
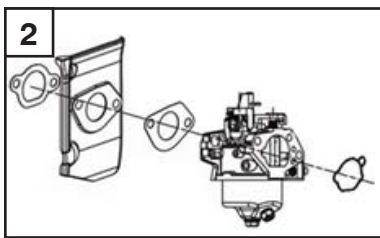
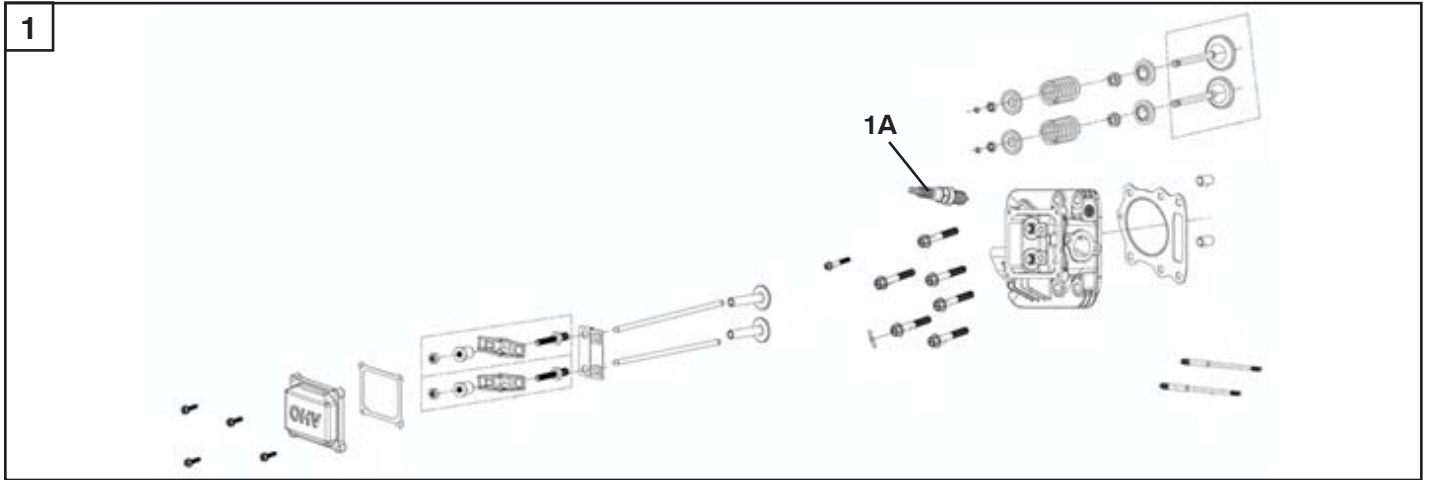

**TRACTOR - - MODEL NO. M110-77X (96021003600), PRODUCT NO. 960 21 00-36
MCCULLOCH ENGINE (352 CC)**

ITEM NO.	PART NO.	DESCRIPTION	QTY.
1	590903601	CYLINDER HEAD COMP KIT	1
1A	591165501	SPARK PLUG	1
2	590903701	CARBURETOR KIT	1
3	590903901	AIR CLEANER KIT	1
4	590904201	GASKET AND SEAL KIT	1
5	590904301	PISTON AND RING SET,PISTON KIT	1
6	590904401	FUEL SYSTEM KIT	1
7	590904701	COVER COMP BREATHER AND VALVE, BREATHER CHAMBER KIT	1
8	590904801	START COVER KIT	1
9	590966001	THROTTLE AND CHOKE ROD KIT	1
10	590970601	AIR FILTER	1
11	590967901	CRANKCASE COVER KIT	1
12	590968001	GOVENOR GEAR KIT	1
13	590968101	BALANCING SHAFT KIT	1
14	590968201	CAMSHAFT	1
15	590968301	CRANKSHAFT	1
16	590968401	BREATHER TUBE KIT	1
17	591165601	SPEED REGULATING ARM KIT	1
18	590968601	HEXAGON BOLT WITH FLANGE	1
19	590968801	VOLTAGE REGULATOR KIT	1
20	590968901	STARTER MOTOR KIT	1
21	592951201	STARTER MOTOR BOLTS	1
22	590969001	IGNITION COIL KIT	1
23	590969101	CHARGING ARMATURE KIT	1
24	590969201	FLYWHEEL KIT	1
25	590969901	IMPELLER KIT	1
26	590969601	STARTING DISC KIT	1
27	590969701	STUD KIT	1
28	590969801	FILL TUBE KIT	1
29	590970001	CONNECTING WIRE	1
30	590970101	EXHAUST PIPE KIT	1
31	590970201	AIR DEFLECTOR	1
32	590970301	VALVE KIT	1
33	590970401	ROCKER ARM KIT	1

