



**Operator's manual**  
**M105-85F**  
**M125-85FH**

Please read the operator's manual carefully and make sure you understand the instructions before using the machine.



**English**

# CONTENTS

## Contents

<b>CONTENTS</b>	
Contents .....	2
<b>INTRODUCTION</b>	
Dear Customer, .....	3
Driving and transport on public roads .....	3
Towing .....	3
Use .....	3
Good service .....	3
<b>Service journal</b>	
Pre-delivery service .....	4
After the first 8 hours .....	4
<b>KEY TO SYMBOLS</b>	
Symbols .....	5
<b>SAFETY INSTRUCTIONS</b>	
Safety instructions .....	7
Driving on slopes .....	8
Children .....	9
Maintenance .....	9
Transport .....	10
<b>WHAT IS WHAT?</b>	
Location of the controls .....	11
<b>PRESENTATION</b>	
Presentation .....	12
Cutting unit .....	13
Seat .....	13
Fueling .....	14
Release lever .....	14
<b>ASSEMBLY</b>	
Assembly .....	15
Fit the steering wheel .....	15
Fit the seat .....	15
Fit cutting unit .....	15
Removing the cutting unit .....	16
Charge the battery .....	16
Connecting the battery .....	16
<b>Driving</b>	
Before starting .....	17
Start the engine .....	17
Starting the engine with a weak battery .....	18
Driving the Rider .....	18
Cutting tips .....	19
Starting on a slope, manual gearbox .....	20
Stop the engine .....	20
<b>Maintenance</b>	
Maintenance schedule .....	21
Cleaning .....	22
Removing of the machine hoods .....	22
Lubrication of drive chain .....	22
Checking the brake .....	23
Adjusting the throttle wire .....	23
Replacing the air filter .....	23
Checking the tyre pressure .....	23
Ignition system .....	24
Fuses .....	24
Check the safety system .....	24
Checking the engine's cooling air intake .....	24
Checking the blades .....	25
<b>Lubrication</b>	
Checking the engine's oil level. ....	26
Replacing the engine oil .....	26
<b>Troubleshooting schedule</b>	
<b>Storage</b>	
Winter storage .....	28
Service .....	28
<b>TECHNICAL DATA</b>	
EC-declaration of conformity .....	30

---

# INTRODUCTION

---

## Dear Customer,

Thank you for choosing a McCulloch Frontmower. McCulloch Front Mower are built to a unique design with a front-mounted cutting unit. The machine is built to give maximum efficiency even in small and confined areas.

This operator's manual is a valuable document. By following its instructions (on operation, service, maintenance, etc.) you will significantly extend the life of the machine and even its second-hand value.

When you sell your McCulloch, make sure you pass on the operator's manual to the new owner. Ensure that all service steps are documented. A well-documented service history reduces the costs of seasonal maintenance and influences the second-hand value of the machine. Take the operator's manual along when the machine is left to the workshop for service.

## Driving and transport on public roads

Check the relevant road traffic regulations before driving the machine on a public road. If transporting the machine on another vehicle always use approved securing devices and make sure that the machine is securely held.

## Towing

When your machine is equipped with a hydrostatic transmission you should only tow the machine over short distances and at a low speed, otherwise there is a risk of damaging the transmission.

The power transmission must be disengaged when towing, see the instructions under the heading Clutch control.

## Use

This ride-on mower is designed to mow grass on open and level ground surfaces. In addition, there is a number of accessories recommended by the manufacturer that broadens the application area. Please contact your dealer for more information about which accessories are available. The machine may only be used with the equipment recommended by the manufacturer. All other types of use are incorrect. Compliance with and strict adherence to the conditions of operation, service and repair as specified by the manufacturer also constitute essential elements of the intended use.

This machine should be operated, serviced and repaired only by persons who are familiar with its particular characteristics and who are acquainted with the relevant safety procedures.

Accident prevention regulations, all other generally recognised regulations on safety and occupational medicine, and all road traffic regulations must be observed at all times.

Any arbitrary modifications carried out to this machine may relieve the manufacturer of liability for any resulting damage or injury.

## Good service

When you need spare parts or support in questions about service, warranty issues, etc., please consult the retail outlet.

- The machine's type designation.
- The manufacturer's type number.
- The machine's serial number.

State the type designation and serial number when ordering spare parts.

---

# Service journal

---

## Pre-delivery service

- 1 Charge the battery for 4 hours at max. 3 amp.
- 2 Fit steering wheel, seat and any optional equipment. See instructions under the heading Assembly.
- 3 Check and adjust tyre pressure. See instructions under the heading Technical data.
- 4 Check that the right amount of oil is in the engine. See instructions under the heading Technical data.
- 5 Connect battery. See instructions under the heading Assembly.
- 6 Fill with fuel and start engine.
- 7 Check that machine does not move in neutral.
- 8 Check:
  - Forward drive. Also see under the Drive system section.
  - Reverse drive. Also see under the Drive system section.
  - Operation of blades.
  - Seat safety switch. See the "Checking the safety system" section.
  - Safety switch for parking brake. See the "Checking the safety system" section.

## After the first 8 hours

- 1 Change engine oil See the "Engine oil change" section.

# KEY TO SYMBOLS

## Symbols

These symbols are on the machine and in the instructions.

**WARNING!** Careless or incorrect use can result in serious or fatal injury to the operator or others.



Please read the operator's manual carefully and make sure you understand the instructions before using the machine.



Always wear:

- Approved hearing protection



This product is in accordance with applicable EC directives.



Reverse



Neutral



Fast



Slow



Stop the engine.



Battery



Choke.



Fuel



Oil level



Cutting height



Backwards



Forwards



Ignition



Warning: rotating parts. Keep hands and feet clear.



Clutch in



Clutch out



Parking brake



Brake



Clutch



Noise emission to the environment according to the European Community's Directive. The machine's emission is specified in the Technical data chapter and on the label.



Rotary blades Keep hands and feet away from under the hood when the engine is running



Do not use the Rider on ground that slopes more than 10°.



Never use the machine if persons, especially children, or animals, are in the vicinity



Never carry passengers on the machine or equipment



Drive very slowly if no cutting unit is fitted



---

## KEY TO SYMBOLS

---

Before and during reversing procedures,  
look behind you.



Watch your hands and other body parts so  
they do not get caught and crushed  
between the belt and belt pulley.



Switch off the engine and take off the ignition  
cable before repairs or maintenance



# SAFETY INSTRUCTIONS

## Safety instructions

These instructions are for your safety. Read them carefully.

### Insure your Rider

- Check the insurance coverage for your new Rider.
- Contact your insurance company.
- You should have fully comprehensive insurance including: third party, fire, damage, theft and liability

### General use

- Read all the instructions in this operator's manual and on the machine before you start it. Ensure you understand them and then observe them.



**WARNING!** This machine produces an electromagnetic field during operation. This field may under some circumstances interfere with active or passive medical implants. To reduce the risk of serious or fatal injury, we recommend persons with medical implants to consult their physician and the medical implant manufacturer before operating this machine.

- Learn how to use the machine and its controls safely and learn to how to stop quickly. Also learn to recognize the safety decals.
- Only allow the machine to be used by adults who are familiar with its use.
- Make sure nobody else is in the vicinity of the machine when you start the engine, engage the drive or drive off.
- Clear the area of objects such as stones, toys, wires, etc. that may become caught in the blades and be thrown out.



- Stop the engine and prevent the engine from being started until you have cleaned the outlet channel.
- Look out for the ejector and do not direct it towards anyone.
- Stop the engine and prevent it from starting before you clean the cutting unit.
- Remember that the driver is responsible for dangers or accidents.

- Never carry passengers. The machine is only intended to be used by one person.



- Always look downwards and backwards before and while reversing. Keep watch for both large and small obstacles.
- Slow before cornering.
- Switch off the blades when you are not mowing.
- Take care when rounding a fixed object, so that the blades do not hit it. Never run the machine over foreign objects.



**WARNING!** This machine can sever hands and feet as well as throw objects. Failure to observe the safety instructions can result in serious injuries.



**WARNING!** Engine exhaust, some of its constituents and certain vehicle components contain or emit chemicals considered to cause cancer, birth defects or other reproductive impairment. The engine emits carbon monoxide, which is a colourless, poisonous gas. Do not use the machine in enclosed spaces.

- Only use the machine in daylight or in other well-lit conditions. Keep the machine at a safe distance from holes or other irregularities in the ground. Pay attention to other possible risks.
- Never use the machine if you are tired, if you have consumed alcohol, or if you are taking other drugs or medication that can affect your vision, judgement or co-ordination.
- Keep an eye on the traffic when working close to a road or when crossing it.
- Never leave the machine unsupervised with the engine running. Always stop the blades, apply the parking brake, stop the engine and remove the keys before leaving the machine.

# SAFETY INSTRUCTIONS

- Never allow children or other persons not trained in the use of the machine to use or service it. Local laws may regulate the age of the user.



**WARNING!** You must use approved personal protective equipment whenever you use the machine. Personal protective equipment cannot eliminate the risk of injury but it will reduce the degree of injury if an accident does happen. Ask your dealer for help in choosing the right equipment.

- Use hearing protection to minimise the risk of hearing impairment.



- Never wear loose-fitting clothing, jewellery or similar that can get caught in moving parts.
- Never use the machine when barefoot. Always wear protective shoes or protective boots, preferably with steel toes.



- Make sure that you have first aid equipment close at hand when using the machine.



## Driving on slopes

Driving on slopes is one of the operations where the risk of the driver losing control of the machine or of it overturning is the greatest; this can result in serious injury or death. All slopes demand extra care. If you cannot reverse up a slope or if you feel unsure, do not mow it.

### IMPORTANT INFORMATION

Do not drive down slopes with the cutting deck raised.

## This is what you do

- Remove obstacles such as stones, branches, etc.
- Mow upwards and downwards, not sideways.

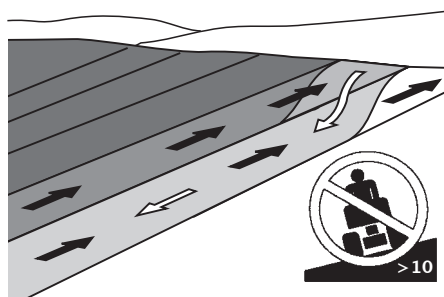

- Do not use the machine on ground that slopes more than 10°.
- Take extra care if any attachments are fitted that can change the stability of the machine.
- Avoid starting or stopping on a slope. If the tyres start to slip, stop the blades and drive slowly down the slope.
- Always drive smoothly and slowly on slopes.
- Do not make any sudden changes in speed or direction.
- Avoid unnecessary turns on slopes, if necessary, turn slowly and gradually downwards if possible. Drive slowly. Do not turn the wheel sharply.

**McCulloch M105-85F:** Select a low gear so that you will not need to stop to change gear. The machine engine-brakes even better in low gear.

- Watch out for and avoid driving over furrows, holes and bumps. It is easier for the machine to overturn on uneven ground. Tall grass can hide obstacles.



- Do not mow too close to edges, ditches or banks. The machine can suddenly overturn if one wheel comes over the edge of a steep slope or a ditch, or if an edge gives way.
- Do not mow wet grass. It is slippery, and tyres can lose their grip so that the machine skids.
- Do not try to stabilize the machine by putting your foot on the ground.
- When cleaning the chassis, the machine may never be driven near verges or ditches.
- When mowing, keep away from bushes and other materials in order to avoid a heating effect.



# SAFETY INSTRUCTIONS

## Children

- Serious accidents may occur if you fail to be on your guard for children in the vicinity of the machine. Children are often attracted to the machine and mowing. Never assume that children will remain where you last saw them.
- Keep children away from the area to be mowed and under close supervision by another adult.
- Keep an eye out and shut off the machine if children enter the work area.
- Before and during reversing procedures, look behind you and down for small children.
- Never allow children to ride along. They can fall off and seriously injure themselves or be in the way for safe maneuvering of the machine.
- Never allow children to operate the machine.

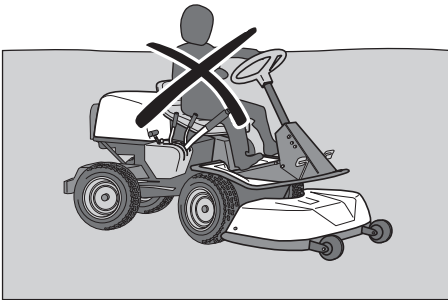

- Be particularly careful near corners, bushes, trees or other objects that block your view.

## Maintenance

- Stop the engine. Prevent starting by removing the ignition cable from the spark plug or remove the ignition key before making any adjustments or carrying out maintenance.
- Never fill the fuel tank indoors.



- Petrol and petrol fumes are poisonous and extremely flammable. Be especially careful when handling petrol, as carelessness can result in personal injury or fire.
- Only store fuel in containers approved for the purpose.
- Never remove the fuel cap and fill the fuel tank when the engine is running.
- Allow the engine to cool before refuelling. Do not smoke. Do not fill with fuel in the vicinity of sparks or naked flames.
- Handle oil, oil filters, fuel and the battery carefully, of environmental considerations. Follow the local recycling requirements.

- Electrical shocks can cause injuries. Do not touch cables when the engine is running. Do not test the ignition system with your fingers.



**WARNING! The engine and the exhaust system become very hot during operation. Risk of burn injuries if touched. When mowing, keep away from bushes and other materials in order to avoid a heating effect.**

- If leaks arise in the fuel system, the engine must not be started until the problem has been resolved.
- Store the machine and fuel in such a way that there is no risk that leaking fuel or fumes can cause any damage.
- Check the fuel level before each use and leave space for the fuel to expand, because the heat from the engine and the sun may otherwise cause the fuel to expand and overflow.
- Avoid overfilling. If you spill petrol on the machine, wipe up the spill and wait until it has evaporated before starting the engine. If you spill on your clothing, change your clothing.
- Allow the machine to cool before performing any actions in the engine compartment.



**WARNING! The battery contains lead and lead pollutants, chemicals that are considered to cause cancer, birth defects or other reproductive impairment. Wash your hands after touching the battery.**

- Be especially careful when handling battery acid. Acid on the skin can cause serious corrosive injuries. In the event of spillage on the skin wash immediately with water.
- Acid in the eyes can cause blindness. Rinse immediately with plenty of water for at least 20 minutes and contact a doctor immediately.
- Take care with battery maintenance. Explosive gases form in the battery. Never perform maintenance on the battery while smoking or in the vicinity of open flames or sparks. This can cause the battery to explode and cause serious injuries.

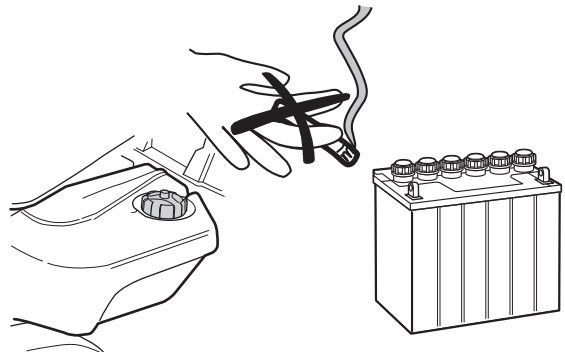

- Make sure all nuts and bolts are tightened correctly and that the equipment is in good condition.
- Do not modify safety equipment. Check regularly to be sure it works properly. The machine must not be driven if protective plates, protective covers, safety switches or other protective devices are not fitted or are defective.

# SAFETY INSTRUCTIONS

- Observe the risk of injury caused by moving or hot parts if the engine is started with the engine cover open or protective cowlings removed.
- Do not change the setting of governors. If you run too fast, you risk damaging the machine components.
- Never use the machine indoors or in spaces lacking proper ventilation. Exhaust fumes contain carbon monoxide, an odourless, poisonous and highly dangerous gas.

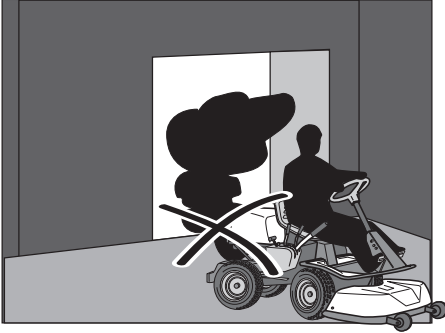

- Stop and inspect the equipment if you run over or into anything. If necessary, make repairs before starting.
- Never make adjustments with the engine running.
- The machine is tested and approved only with the equipment originally provided or recommended by the manufacturer.
- The blades are sharp and can cause cuts. Wrap the blades or wear protective gloves when handling them.
- Check regularly that the parking brake works. Adjust and maintain as required.
- Reduce the risk of fire by removing grass, leaves and other debris that may have fastened on the machine. Allow the machine to cool before putting it in storage.

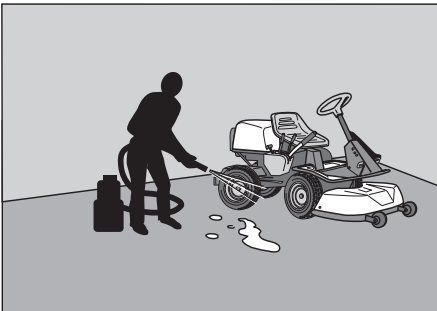

## Transport

### IMPORTANT INFORMATION

The parking brake is not sufficient to lock the machine during transport. Ensure you secure the machine firmly to the transporting vehicle.

- The machine is heavy and can cause serious crush injuries. Take extra care when loading it onto or off a vehicle or trailer.
- Use an approved trailer to transport the machine.  
To secure the machine on the trailer, two approved tension belts and four wedge shaped wheel blocks should be used.

Engage the parking brake and tie the tension belts around stable parts on the machine, e.g. frame or rear wagon. Secure the machine by tensioning the belts towards the back and the front of the trailer respectively.

Place the wheel blocks in front of and behind the rear wheels.

- Check and observe local road traffic regulations before transporting or driving the machine on roads.

# WHAT IS WHAT?

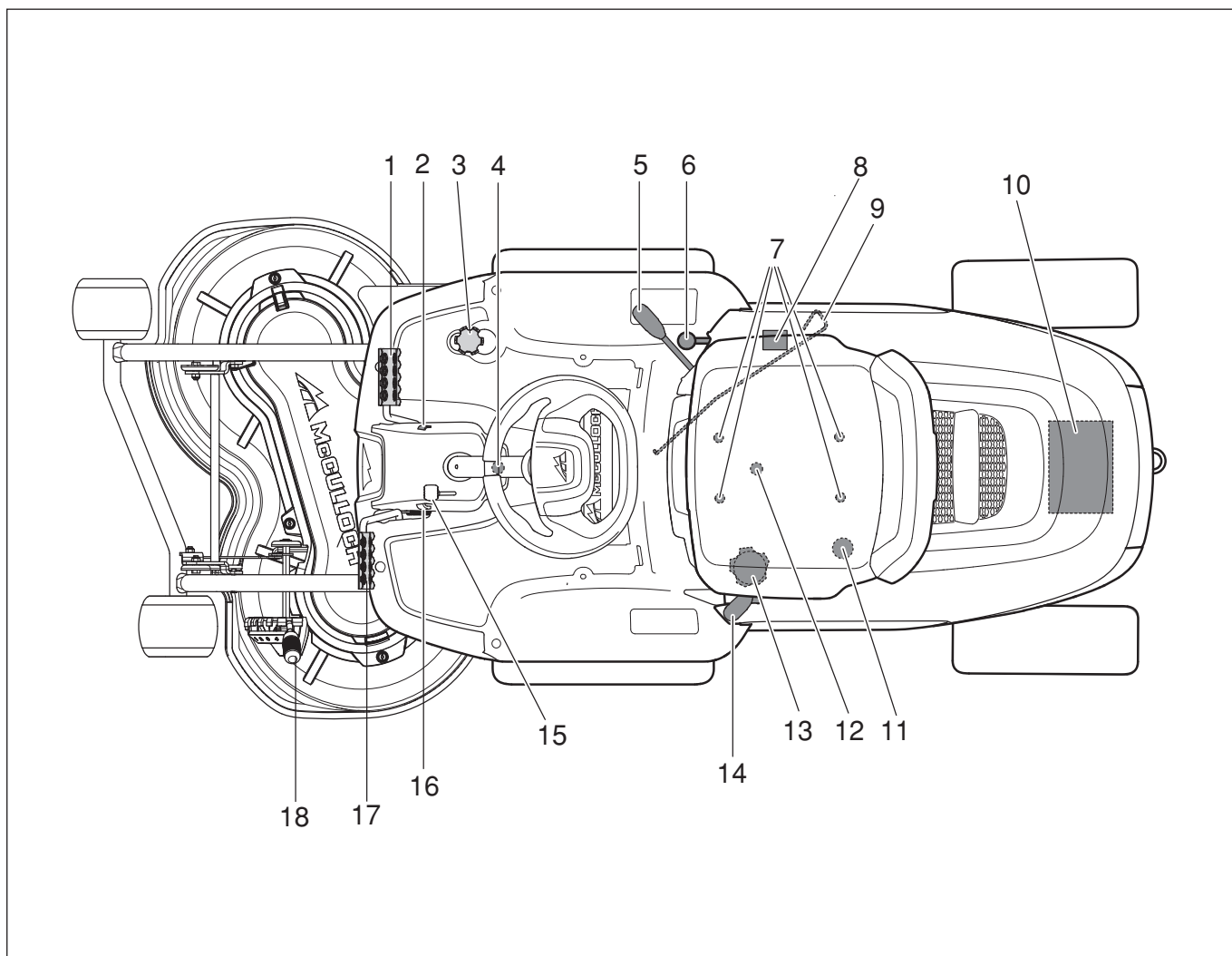

## Location of the controls

- |   |   |    |  |
|---|---|----|--|
| 1 | Speed limiter for driving forward M125-85FH<br>Clutch pedal, neutral and parking brake M105-85F | 10 | Battery  |
| 2 | Lock button for parking brake M105-85F  | 11 | Dipstick                                       |
| 3 | Speed limiter for reversing, M125-85FH  | 12 | Cover lock                                     |
| 4 | Ignition lock   | 13 | Fuel cap                                       |
| 5 | Gear shift lever, M105-85F  | 14 | Controls for operating the cutting unit blades |
| 6 | Parking brake, M125-85FH  | 15 | Throttle control/choke control                 |
| 7 | Seat adjustment.  | 16 | Lock button for the cutting deck (suspended)   |
| 8 | Product and serial number plate   | 17 | Lifting pedal for cutting deck                 |
| 9 | Lever to disengage the drive M125-85FH  | 18 | Cutting height adjustment lever                |

# PRESENTATION

## Presentation

Congratulations on your choice of an excellent quality product that will give you great pleasure for many years.

McCulloch M105-85F has a gearbox of "inline" type with 3 forward gears and 1 backward gear.

On McCulloch M125-85FH, the power transmission is handled by a hydrostatic gearbox which allows variable variation of the speed.

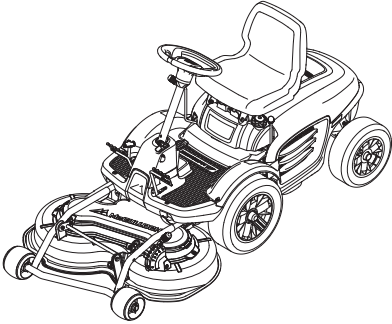

## Brake/Clutch pedal M105-85F

One pedal in the machine is used as a brake and clutch.

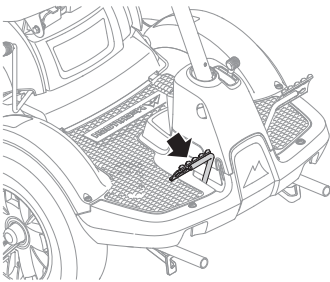

The brake and clutch are engaged by pressing down the pedal entirely. The clutch pedal disengages the engine and stops propulsion. The blade drive is not affected by the clutch pedal.

The brake pedal activates a disc brake that is located on the gearbox and stops the drive gear.

## Parking brake M105-85F

The parking brake is applied as follows:

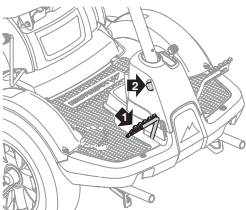

- 1 Press down the parking brake pedal.
- 2 Press in the lock button on the steering column.
- 3 Release the parking brake pedal while keeping the button pressed in.

The parking brake lock disengages automatically when the brake pedal is pressed.

## Parking brake M125-85FH

The parking brake is applied as follows:

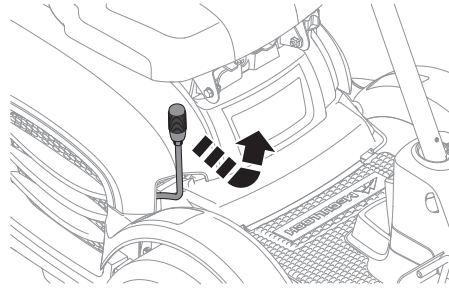

- 1 Slide the parking brake lever forward.
- 2 Hook the lever in place in the most forward position.

## Throttle and choke controls

The throttle control regulates the engine speed, and thereby also the rotation speed of the blades.

The control is also used to activate the choke. When the choke is engaged a richer fuel and air mixture is fed to the engine, which facilitates starting in the cold.

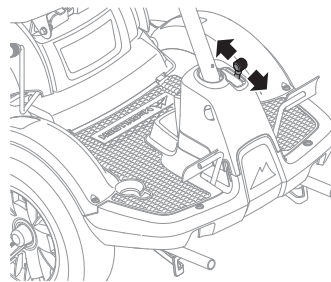

## Speed limiter M125-85FH

The speed of the machine is steplessly regulated with two pedals. Pedal (1) is used to drive forwards, and pedal (2) to drive backwards.

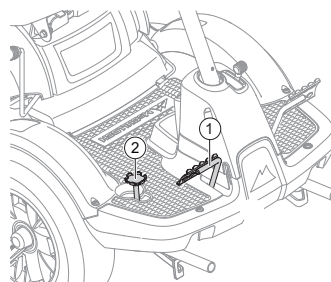

**WARNING!** Make sure that branches do not obstruct the pedals when mowing under bushes. Otherwise there is a risk you may lose control.

# PRESENTATION

## Cutting unit

The machines have cutting units with rear ejection, i.e. clippings are thrown behind the cutting unit.

## Lifting pedal for cutting deck

The lifting pedal is used to put the cutting deck in either the transport or mowing positions.

If the pedal is pressed down, the cutting deck is raised to the transport position.

The transport position is activated as follows:

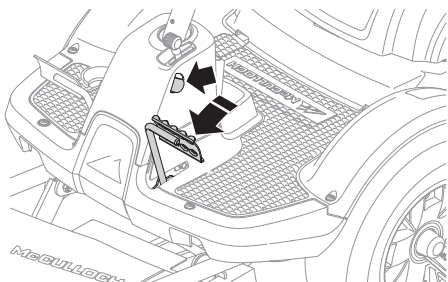

- 1 Press down the lifting pedal for the cutting deck.
- 2 Press in the lock button on the steering column.
- 3 Release the lifting pedal while keeping the button pressed in.

If the lifting pedal is released without pressing in the lock button, the cutting deck will be lowered to the mowing position.

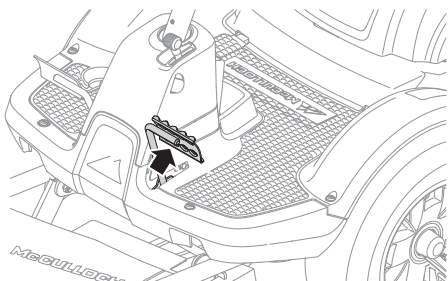

The pedal can also be used to temporarily adjust the cutting height, such as when passing a minor bump in the lawn.

## Operation of blades.

Loosen the lever, move it forward and the blades start to rotate.

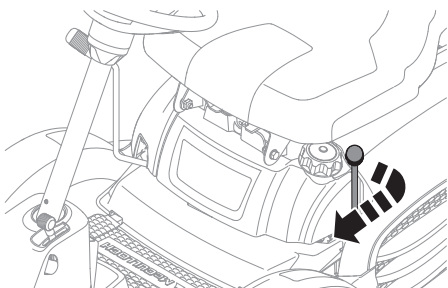

Move the lever back and lock it to stop the blades from rotating.

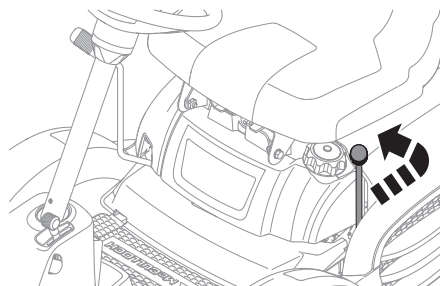

## Cutting height adjustment lever

The cutting height can be adjusted to 5 (1-5) different positions with the cutting height lever.

Position 1 indicates the lowest cutting height and position 5 the highest.

Never use position S when mowing. Position S is the service position.

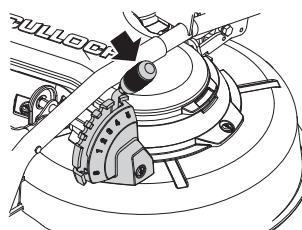

## Seat

The seat has a jointed attachment on the front edge and can be tipped forward.

The seat can also be adjusted lengthways.

Loosen the bolts under the seat and adjust it forwards or backwards to the desired position.

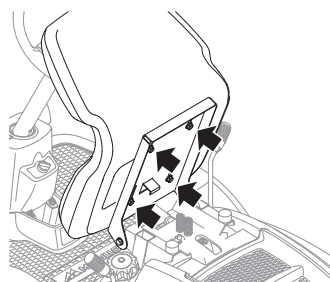

# PRESENTATION

## Fueling

The engine runs on unleaded petrol with a minimum octane rating of 85 (not mixed with oil). We recommend the use of biodegradable alkylate petrol.

Always use fresh and clean, unleaded petrol. Do not use petrol that contains methanol.

Do not fill the tank completely, leave an expansion area of at least 2.5 cm (1").

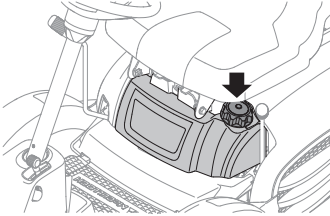

**WARNING! Petrol is highly inflammable. Exercise care and refuel outdoors (see safety instructions).**

### IMPORTANT!

Do not use the fuel tank as a support area.

## Release lever M125-85FH

The release control must be pulled out in order for the machine to be moved when the engine is shutoff. Pull the controls to the end positions, do not use an intermediate position.

- Turn off the motor.
- Pull out the control to disengage the drive system.

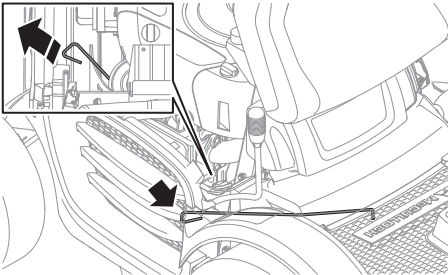

- Push in the control to engage to the drive system.

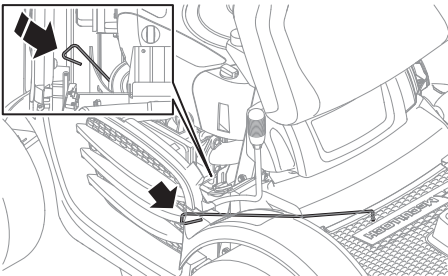

# ASSEMBLY

## Assembly

The ride-on mower must first be assembled before it can be used.

### Fit the steering wheel

Fit the steering wheel/steering rod on the control rod shaft, ensure that the holes are aligned, and knock the spring pin in all the way through the steering rod.

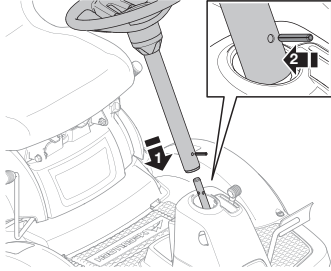

### Fit the seat

Fit the seat with the four supplied washers and screws.

Adjust the seat to the required position.

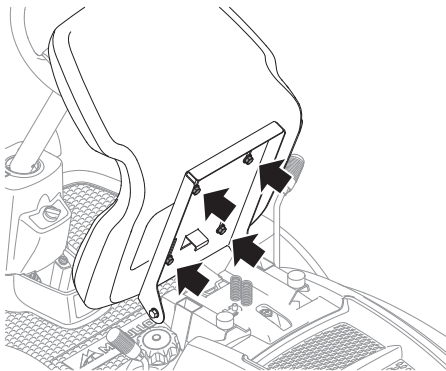

### Fit cutting unit.

Attach the cutting deck according to the following instructions, which can also be found under the cutting deck cover.

- 1 Apply and lock the parking brake.
- 2 Place the belt under the stay of the cutting deck.

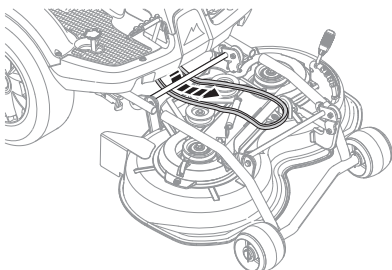

- 3 Check that the lever for setting the cutting height is in the S position.

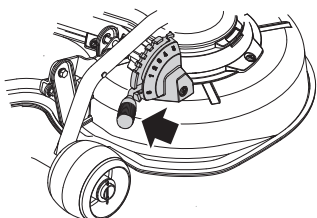

- 4 Fit the cutting deck's pipe together with the deck frame's pipe.

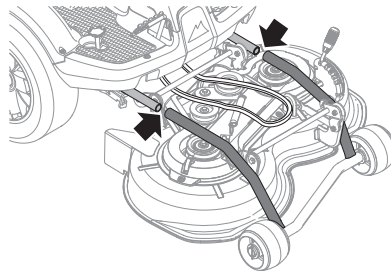

- 5 Push the cutting deck in and make sure the guide bolts fit into the grooves on the deck frame, one on each side.

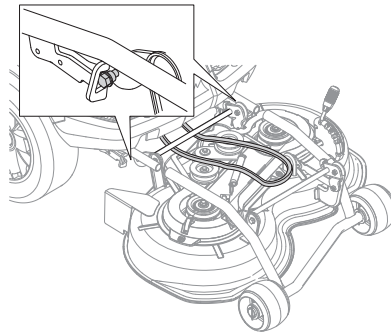

- 6 Grab the pipes and push the deck in. Push the deck until you feel the pipes touch bottom.

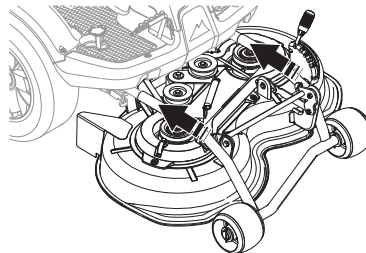

- 7 Fit the belt according to the picture.

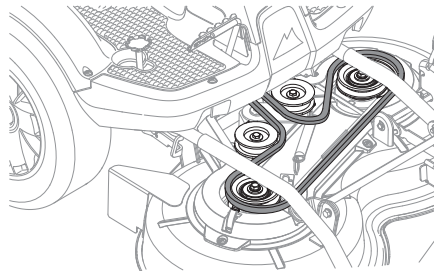

- 8 Tension the belt with the belt adjuster.

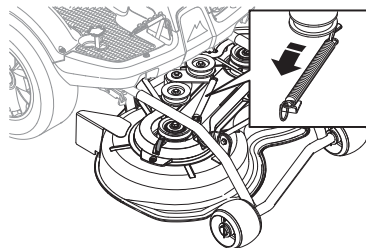

# ASSEMBLY

- 9 Fit the front cover.

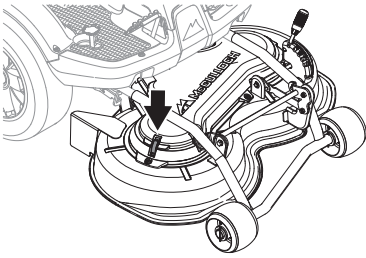

- 10 Set the cutting deck height control in any of the positions 1-5.

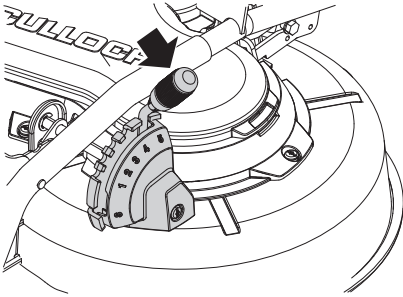

## Removing the cutting unit

The cutting deck can be removed in order to facilitate cleaning and servicing.

To remove the cutting deck proceed as follows:

- 1 Position the machine on flat ground.
- 2 Apply and lock the parking brake.
- 3 Check that the lever for setting the cutting height is in the S position.

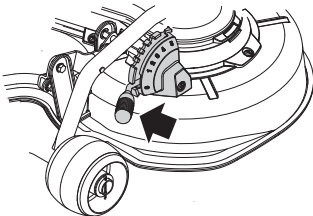

- 4 Lower the cutting deck to the mowing position.

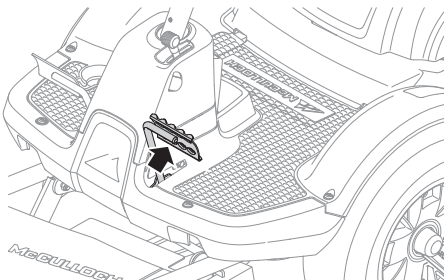

- 5 Release the clip on the right side of the mower deck and lift the cover off the mower deck.

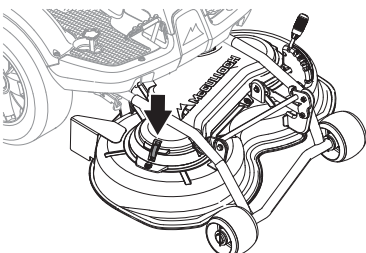

- 6 Disengage the spring for the drive belt tensioning wheel.

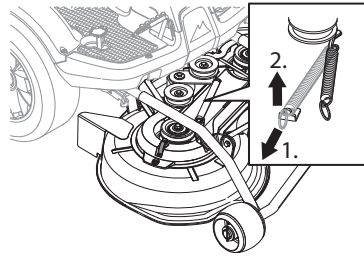

- 7 Remove the belt.

- 8 Grab the upper pipe construction of the deck and pull it out.

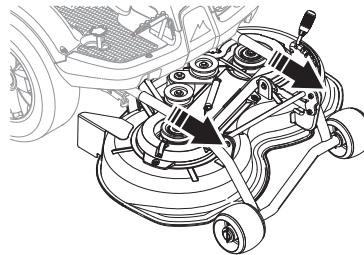

## Charge the battery

The battery must be charged with max. 3 Amp for 4 hours before using the lawnmower for the first time. See the battery charger instructions on how to connect the battery charger.

## Connecting the battery

When the battery is fully charged, connect the red cable to the positive pole (+pole) of the battery and the black and blue cable to the negative pole (-pole).

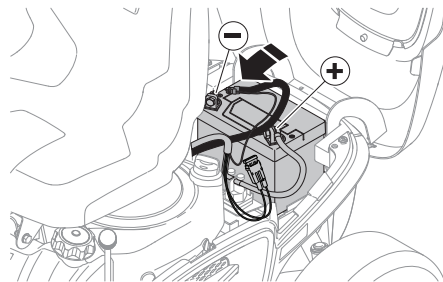



## Before starting

### IMPORTANT!

The air intake grille in the engine cover behind the driver's seat must not be blocked by, for example, clothing, leaves, grass or dirt.

Impaired cooling of the engine. Risk of major engine damage.

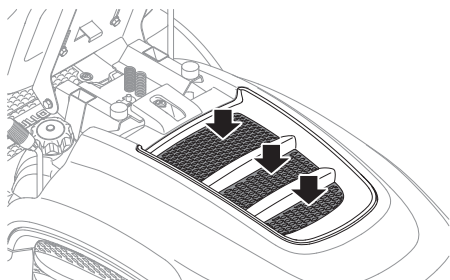

- Read the safety instructions and information concerning the placement of controls and functions before starting.
- Perform daily maintenance before starting as set out in the Maintenance schedule.

Adjust the seat to the required position.

## Start the engine

- 1 **M125-85FH** Make sure that the clutch control is depressed. (Run position)

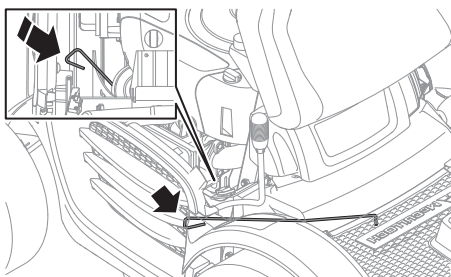

- 2 Make sure the blades are not rotating by sliding the lever backwards and locking it in the locked position.

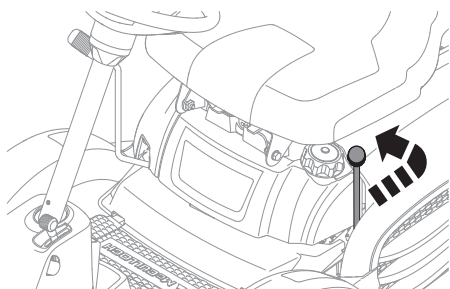

- 3 Activate the parking brake. This is done as follows:

### M105-85F

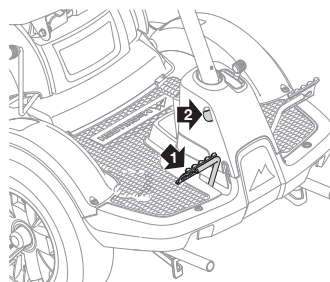

- Press down the parking brake pedal (1).
- Press in the lock button (2) on the steering column.
- Release the brake pedal while holding the button pressed.

The parking brake lock disengages automatically when the brake pedal is pressed.

### M125-85FH

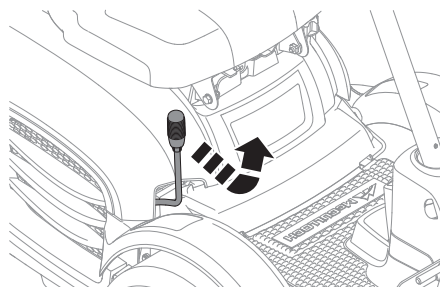

- Slide the parking brake lever forward.
- Hook the lever in place in the most forward position.

The engine can not be started if the parking brake is not pressed down.

### 4 M105-85F

Put the gear shift lever in the "N" position (neutral).

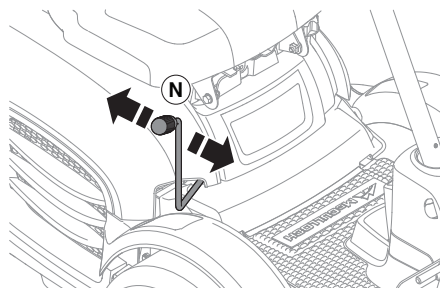

- 5 Move the throttle to position 3 (choke position). In this position the engine is fed with a richer mixture, which means the engine is easier to start.

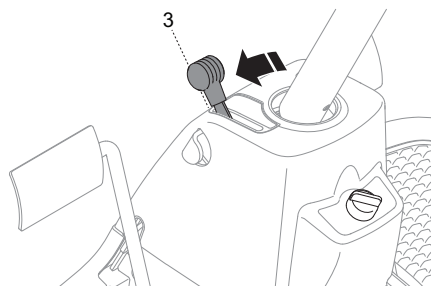

# Driving

- 6 Move the throttle in between positions 1 and 2.

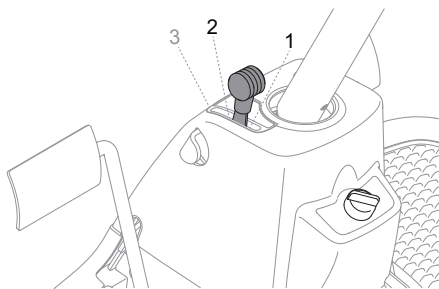

- 7 Turn the ignition key to the start position.

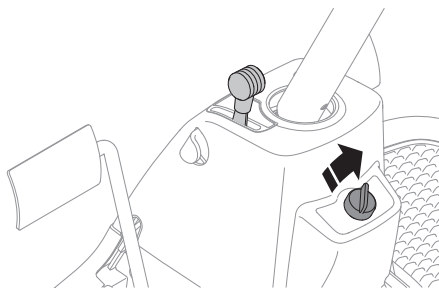

## IMPORTANT INFORMATION

If the engine does not start wait about 1 minute before trying again.

- 8 When the engine starts release the ignition key immediately back to neutral position.

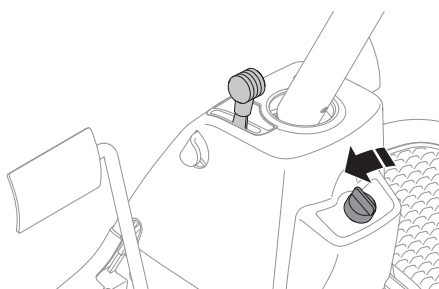

- 9 Move the throttle backwards gradually once the engine has started. Let the engine run at moderate speed or half throttle for 3-5 minutes before subjecting it to heavy load.
- 10 Set the required engine speed with the throttle control.



**WARNING!** Never run the engine indoors, in enclosed or poorly ventilated areas. The exhaust fumes contain toxic carbon monoxide.

## Starting the engine with a weak battery

If the battery is too weak to start the engine, it should be recharged. Charge the battery for 4 hours at max. 3 amp.

When jump leads are used for emergency starting, follow the procedure below:



**IMPORTANT INFORMATION** Your Rider is equipped with a 12-volt system with negative earth. The other vehicle must also have a 12-volt system with negative earth.

## Connecting the jump leads

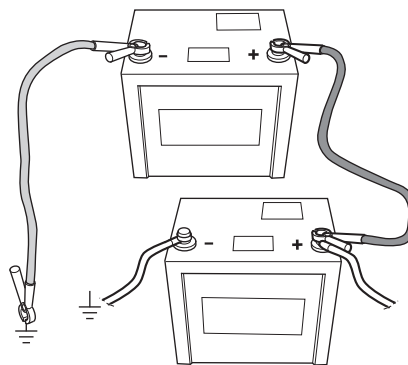

- Connect each end of the red cable to the POSITIVE pole (+) on each battery, exercise care not to short circuit any of the ends against the chassis.

Connect one end of the black cable to the NEGATIVE pole (-) on the fully charged battery.

- Connect the other end of the black cable to a good CHASSIS EARTH, away from the fuel tank and the battery.

## Remove the cables in the reverse order

- The BLACK cable is removed from the chassis and then the fully charged battery.
- Finally the RED cable from both batteries.

## Driving the Rider

- 1 Release the parking brake.

### M105-85F

Release the parking brake by first pressing down the parking brake pedal and then releasing it.

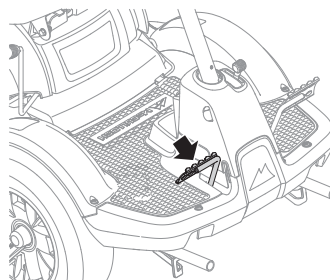

### M125-85FH

Release the parking brake by moving the lever backwards.

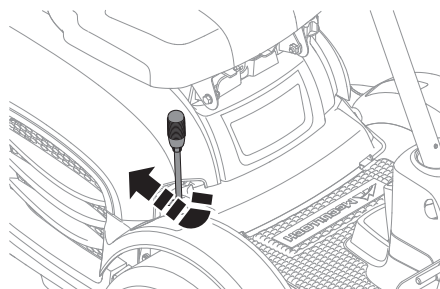

- 2 M105-85F

Disengage the engine and select the required gear. Gradually release the clutch pedal.

# Driving

Starting can take place independent of which gear is engaged.

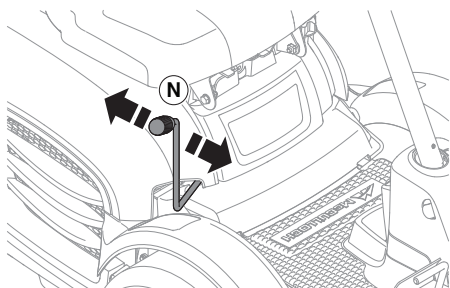

Lift and pull the lever backwards to reverse.

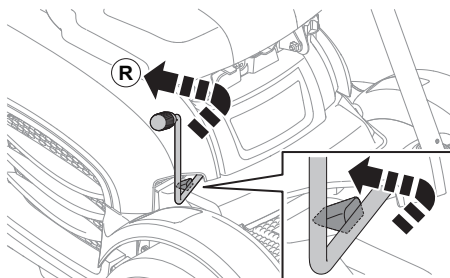

**IMPORTANT!** Gear changes between forward gears must not be made while the machine is moving.

The engine must be disengaged during each gear change.

Stop the machine before changing between forward and reverse gears, otherwise this may result in damage to the gearbox.

Never use force to engage a gear. If a gear does not engage immediately, release the clutch pedal and press it down again. Now try to engage the gear again.

### 3 M125-85FH

Carefully press down one of the pedals until the required speed is obtained. Pedal (1) is used to drive forwards, and pedal (2) to drive backwards.

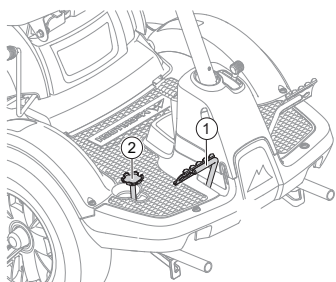

### 4 Select the required cutting height (1-5) using the cutting height lever.

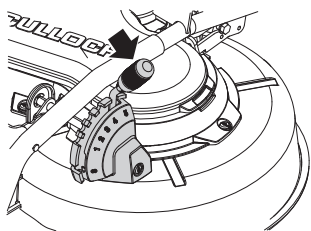

**IMPORTANT!**

Never use position S when mowing. Position S is the service position.

### 5 Lower the cutting unit.

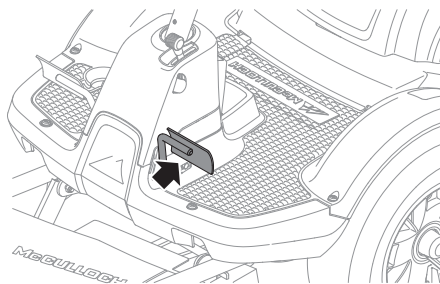

### 6 Start the blades by first releasing the lever and then moving it forward.

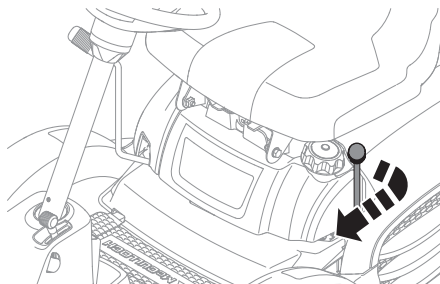

### IMPORTANT INFORMATION

The life span of the drive belts is increased significantly if the engine runs at a low speed when the blades are engaged. Therefore apply full throttle first when the cutting unit has been moved to the mowing position.

## Cutting tips

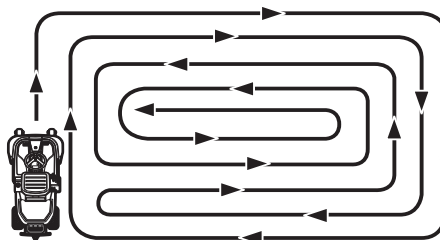

**WARNING!** Clear the lawn from stones and other objects which can be thrown out by the blades.

- Localise and mark stones and other fixed objects to avoid collision.
- Start with a high cutting height and reduce down until the required mowing results are obtained.
- The mowing result will be best with the highest permitted engine speed, see technical data, (the blades rotate rapidly) and low speed (the Mower moves slowly). If the grass is not too high and thick, the driving speed can be increased without noticeably depreciating the mowing result.
- The best lawns are achieved if the grass is cut often. Mowing becomes more uniform and the grass cuttings become more evenly distributed over the surface. The total time consumption is not greater since it is possible to select a higher driving speed without inferior mowing results.

# Driving

- In order to obtain an even cutting height, it is important that the air pressure is the same in both front wheels. See the "Technical data" section.
- Avoid mowing a wet lawn. The mowing results are inferior since the wheels sink down into the soft lawn.
- Hose down the cutting unit with water underneath each time it is used.



**WARNING! Do not use the machine on ground that slopes more than 10°. Mow slopes upwards and downwards, never across. Avoid sudden changes in direction.**

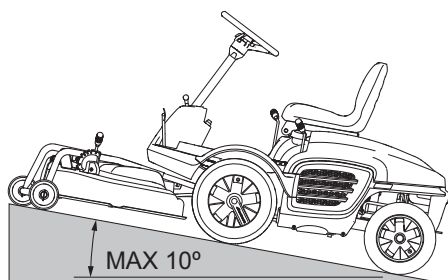

## Starting on a slope, manual gearbox M105-85F

- 1 Press down the parking brake pedal.
- 2 Push the throttle control to full throttle position.
- 3 Disengage the engine and select 1st gear.
- 4 Gradually release the clutch pedal.

## Stop the engine

Preferably allow the engine to idle for a minute to obtain normal working temperature before stopping it if it has been working hard. Avoid idling the engine for long periods, as there is a risk of carbon build-up on the spark plugs.

- 1 Disengaging the blades.

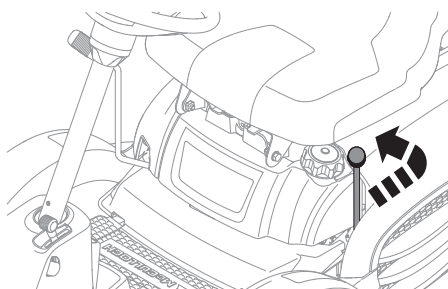

- 2 Lift up the cutting deck by stepping on the lifting pedal and pressing in the lock button.

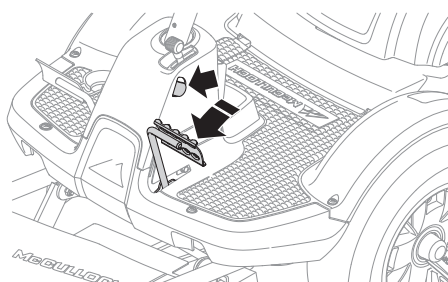

- 3 **M105-85F** Pull back the throttle and move the gear shift lever to "N" – neutral position. Turn the ignition key to the "STOP".

**M125-85FH** Pull back the throttle and turn the ignition key to the "STOP" position.

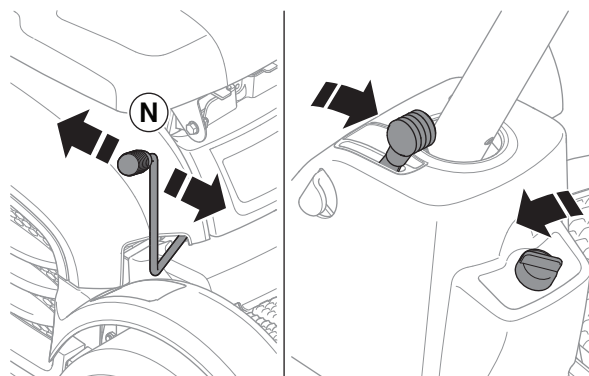

- 4 When the ride-on mower is at a standstill, engage the parking brake.

# Maintenance

## Maintenance schedule

The following is a list of the maintenance which should be conducted on the machine. For those points not described in this manual, visit an authorised service workshop.

Maintenance	Daily maintenance before starting	At least once a year	Maintenance interval in hours			
			25	50	100	200
Cleaning	X					
Check the engine's oil level	X					
Check the engine's cooling air intake	X					
Check the brakes	X					
Check the battery	X					
Lubricate the drive chain, M105-85F	X					
Check the safety system	X					
Check nuts and screws	O					
Check for fuel and oil leakage.	O					
Clean around the silencer	O					
Change engine oil <sup>1)</sup>			X	X		
Replace the air filter <sup>2)</sup> .			X			
Check the cutting deck			X			
Check the tyre pressures.			X			
Lubricate joints and shafts <sup>3)</sup>			X			
Check the V-belts			O			
Checking and adjusting of throttle wire				X		
Replace the fuel filter					O	
Replace the spark plug.					X	
Check the fuel hose. Replace if necessary . <sup>4)</sup>		O				

<sup>1)</sup>First change after 8 hours. When operating with a heavy load or at high ambient temperatures, replace every 25 hours. <sup>2)</sup>Clean and replace the filter more often in dusty conditions. <sup>3)</sup>If the machine is used daily it should be lubricated twice a week. <sup>4)</sup>Conducted by authorised service workshop.

X = Described in this operator's manual

O = Not described in this operator's manual



**WARNING! No service procedures must be conducted on the engine or cutting unit unless:**

**The engine is switched off.**

**The ignition key is removed.**

**The ignition cable has been removed from the spark plug.**

**The parking brake is applied.**

**The cutting unit is disengaged.**

# Maintenance

## Cleaning

Clean the machine directly after use. It is much easier to wash off grass cuttings before they dry.

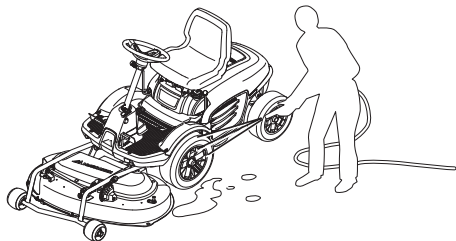

Oily dirt can be removed using a cold degreasing agent. Spray on a thin layer.

Rinse at normal water pressure. Do not use a high pressure washer to clean the machine.

Do not direct the jet towards electrical components or bearings.

Do not rinse hot surfaces such as the engine and exhaust system.

Hose down the cutting unit with water underneath each time it is used.

It is recommended that you start the engine and run the mower for a short period after cleaning, so that any remaining water is blown off.

Lubricate the machine if necessary after cleaning. Carry out extra lubrication when the bearings have been exposed to a degreaser or a water jet.

**IMPORTANT!** Avoid using a high pressure washer or a steam cleaner.

There is a major risk of water penetrating into bearings and electrical connections. Corrosion attack can result, which will lead to running problems. Cleaning additives generally aggravate the damage.

## Removing of the machine hoods

### Engine cover

The engine becomes accessible for service when the engine cover is opened.

Fold the seat forward, loosen the screw under the seat and push the cover backwards.

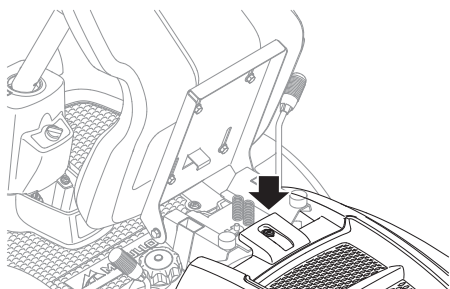

### Front cover

Release the clip on the right side of the mower deck and lift the cover off the mower deck.

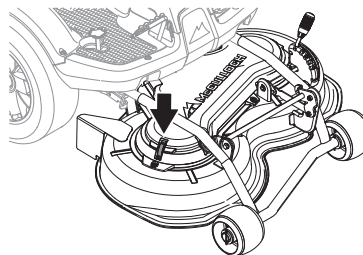

### Service hatch

Loosen the service cover by inserting a screwdriver in the front edge and lift off the cover.

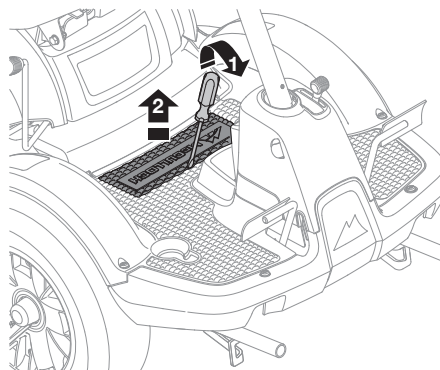

To put back the cover, it must first be bent and inserted at the sides. Then press down the cover.

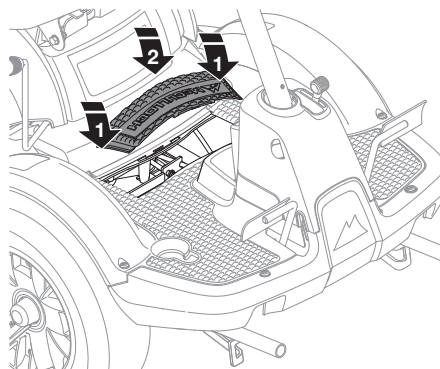

## Lubrication of drive chain M105-85F

- 1 Remove the service hatch.

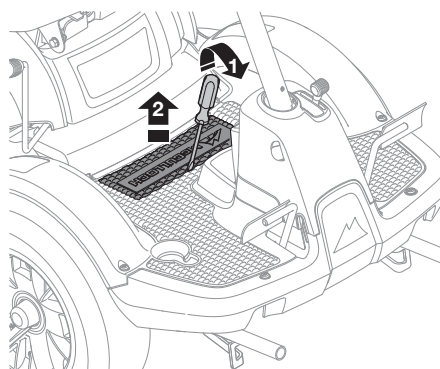

# Maintenance

- 2 Lubricate the drive chain with engine oil or other good quality oil. This is required every 10 hours of running time to maintain full functionality and service life.

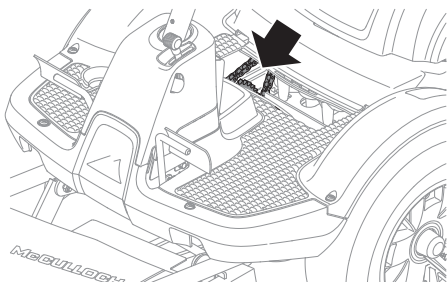

- 3 Refit the service cover.

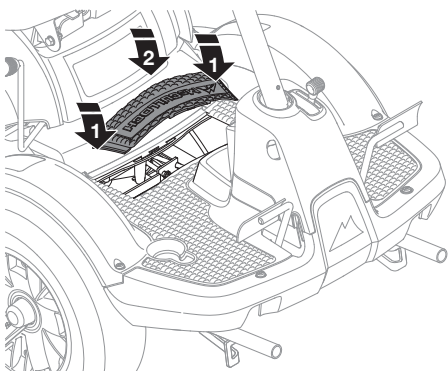

## Checking the brake M105-85F

The brake is a disc brake and is located on the gearbox.

Make sure the brake is adjusted correctly by braking sharply at full speed on level ground. Use a service workshop to perform this task.

## Adjusting the throttle wire

The throttle cable may need to be adjusted, if the engine does not respond as it should when accelerating, if it produces black smoke or maximum revs are not reached. Use a service workshop to perform this task.

## Replacing the air filter

If the engine seems to lack power or does not run smoothly this may be because the air filter is clogged. It is therefore important to replace the air filter at regular intervals (see Maintenance/Maintenance Schedule for the correct service interval).

Replace the air filter as follows:

- 1 Open the engine cover.

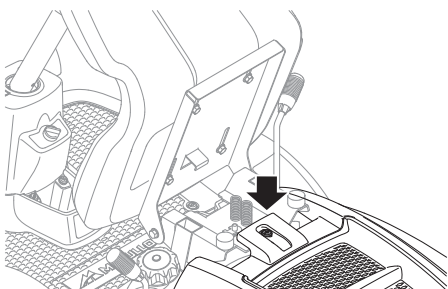

- 2 Loosen the knobs holding the filter cover in place and remove it.

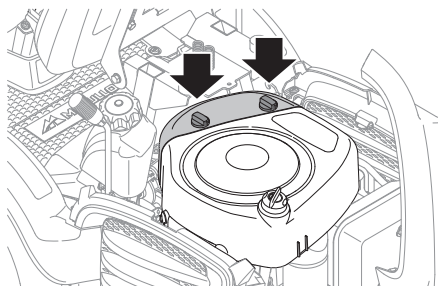

- 3 Lift out the air filter cartridge from the fan housing.

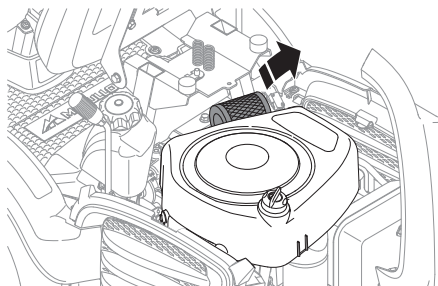

- 4 Replace the air filter cartridge, if clogged with dirt.

### IMPORTANT INFORMATION

Do not use compressed air to clean the paper filter.

Do not oil the paper filter. They must be fitted dry. Carefully clean the fan housing so that dirt does not fall down into the carburettor.

- 5 Refit the air filter and air filter cover.

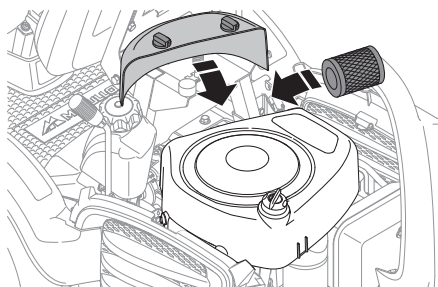

## Checking the tyre pressure

The tyre pressure should be 1 bar / 100 kPa / 14,5 PSI for all wheels

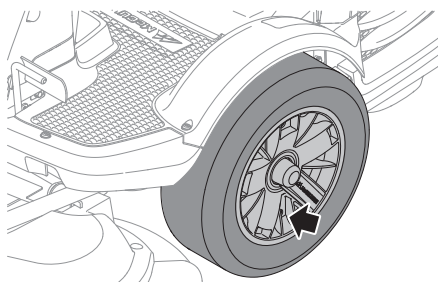

**IMPORTANT INFORMATION** Different tyre pressures on the front tyres will result in the blades cutting the grass at different heights.

# Maintenance

## Ignition system

The engine is equipped with an electronic ignition system. Only the spark plug requires maintenance.

For recommended spark plug, see Technical data.

### IMPORTANT INFORMATION

Fitting the wrong spark plug type can damage the engine.

## Replacing the spark plug

- 1 Remove the ignition cable shoe and clean around the spark plug.
- 2 Remove the spark plug with a 5/8" (16 mm) spark plug socket wrench.
- 3 Check the spark plug. Replace the spark plug if the electrodes are burned or if the insulation is cracked or damaged. Clean the spark plug with a steel brush if it is to be reused.
- 4 Measure the electrode gap with a gapping tool. The gap should be 0.75 mm/0.030". Adjust as necessary by bending the side electrode.
- 5 Reinsert the spark plug, turning by hand to avoid damaging the threads.

### IMPORTANT INFORMATION

Inadequately tightened spark plugs can cause overheating and damage the engine. Tightening the spark plug too much can damage the threads in the cylinder head.

- 6 Tighten the spark plug, once it touches the seating, with the spark plug spanner. Tighten the spark plug so that the washer is compressed. A used spark plug should be turned 1/8 of a turn from the seated position. A new spark plug should be turned a 1/4 turn from the seated position.
- 7 Replace the ignition cable shoe.

### IMPORTANT INFORMATION

Do not turn over the engine if the spark plug or ignition cable has been removed.

## Fuses

The main fuse is placed in a detachable holder behind the battery under the protective cover.

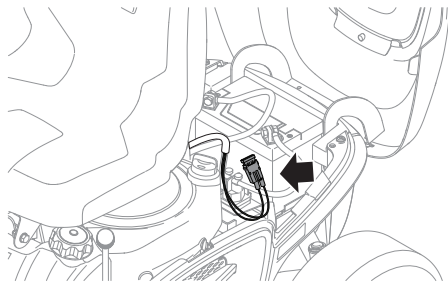

Type: Flat pin, 15 A.

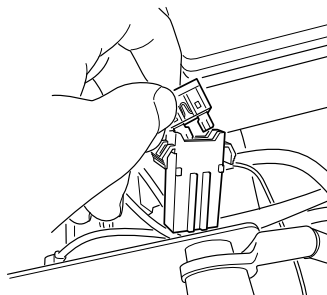

Do not use any other type of fuse when replacing.

A blown fuse is indicated by a burnt connector. Pull the fuse from the holder when replacing.

The fuse is there to protect the electrical system. If it blows again shortly after replacement, it is due to a short circuit, which must be fixed before the machine can be put into operation again.

## Check the safety system

The machine is equipped with a safety system that prevents starting or driving under the following conditions.

The engine must only be possible to start when the following conditions are met:

- Drive - blades deactivated
- The parking brake is applied.

The driver does not need to be seated in the driver's seat.

Check daily to ensure that the safety system works by attempting to start the engine when one of the conditions above is not met. Change the conditions and try again.

Check that the engine stops if you temporarily move out of the driver's seat while the mower blades are engaged.

## Checking the engine's cooling air intake

Clean the air intake grille in the engine cover behind the driver's seat.

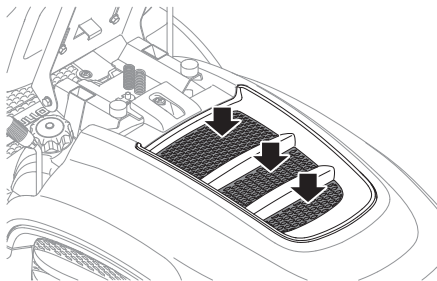

Open the engine cover.

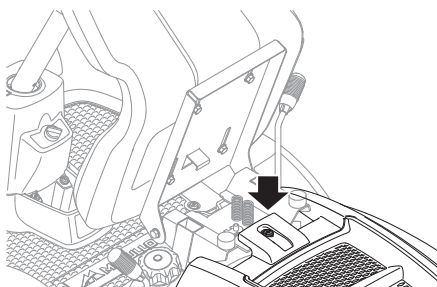



# Maintenance

Check that the cooling intake is free from leaves, grass and dirt.

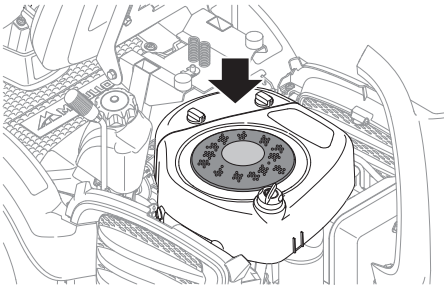

A blocked cooling intake will interfere with the cooling of the engine, which can damage the engine.



**WARNING!** The cooling air intake rotates when the engine is running. Mind your fingers.

## Checking the blades

To achieve the best mowing results it is important that the blades are undamaged and well-sharpened.

Check that the blades' attachment screws are tight.

- Remove the cutting deck. See the "Removing the Cutting Deck" section.

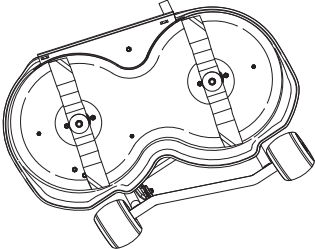

### IMPORTANT INFORMATION

Replacement or sharpening of the blades must be carried out by an authorised service workshop. The blades must be balanced after sharpening.

Damaged blades should be replaced when hitting obstacles that result in a breakdown. Let the service centre assess whether the blade can be sharpened or must be replaced.



**WARNING!** Do not use blades that are cracked, chipped, or otherwise show signs of damage or severe wear. Replace the blades. The risk increases if the blades are poorly balanced.

# Lubrication

## Checking the engine's oil level.

Check the oil level in the engine when the Rider stands horizontal with the engine switched off. Do not check the oil with the engine running.

Open the engine cover.

Loosen the dipstick, pull it up and wipe it off.

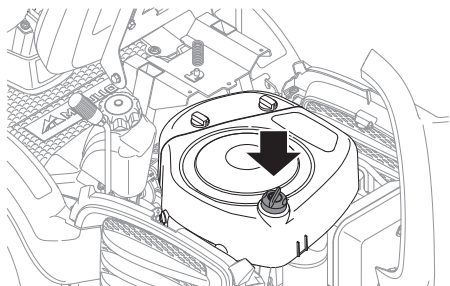

The dipstick should be **completely screwed down**

Pull the dipstick out again and read the oil level.

The oil level should be between the markings on the dipstick.

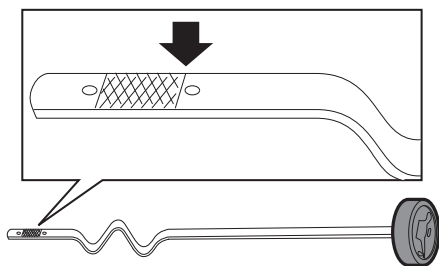

The oil is topped up through the hole the dipstick sits in.

Fill the oil slowly. Tighten the dipstick correctly before starting the engine. Start and run the engine at idling speed for approx. 30 seconds. Turn off the motor. Wait 30 seconds and check the oil level. If necessary fill so that the oil comes up to the upper marking on the dipstick.

See the "Technical data" section for type of engine oil.

Do not mix different types of oil.

## Replacing the engine oil

The engine oil should be changed the first time after 8 hours running time. It should then be changed after every 50 hours of running time.

When operating with a heavy load or at high ambient temperatures, replace every 25 hours.



**WARNING! Engine oil can be very hot if it is drained directly after stopping the engine. Allow the engine to cool somewhat first.**

- 1 Place a container underneath the engine oil drain plug.
- 2 Remove the dipstick.

- 3 Remove the drain plug from the engine.

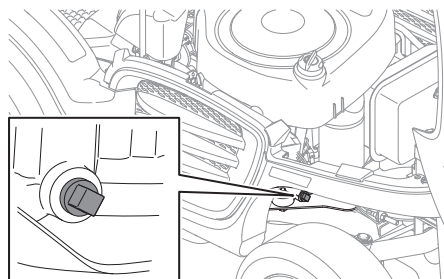

- 4 Let the oil run out into the container.
- 5 Fit the drain plug and tighten it.
- 6 Fill with oil up to the "FULL" mark on the dipstick. The oil is topped up through the hole the dipstick sits in. See Checking the engine's oil level for filling instructions.  
  
The engine holds 1.5 litres (1.6 USqt) when the oil filter is not replaced and 1.7 litres (1.8 USqt) of oil when the oil filter is replaced.
- 7 Run the engine warm, then check that there is no leakage from the oil plug.

### IMPORTANT INFORMATION

Used engine oil, antifreeze etc. is a health hazard and must not be disposed of on the ground or in nature; it should always be disposed of at a workshop or appropriate disposal location.

Avoid skin contact; wash with soap and water in case of spills.

# Troubleshooting schedule

Problem	Cause
<b>Engine does not start</b>	There is no fuel in the fuel tank
	Faulty spark plug.
	See the "Checking the Safety System" section if the controls are in the wrong position.
	Faulty spark plug connections or interchanged cables
	Dirt in the carburettor or fuel line
	Starter motor does not turn over the engine
	Dirt, water or stale fuel in the tank.
<b>Starter motor does not turn over the engine</b>	Incorrect fuel in the fuel tank
	Battery flat
	Bad contact between the cable and battery
	Lift lever for cutting unit in wrong position
	Main fuse blown.
	Ignition lock faulty
	Faulty starter motor
<b>Engine does not run smoothly</b>	Faulty spark plug.
	Carburettor incorrectly set
	Air filter clogged
	Fuel tank vent blocked
	Ignition key defective
	Dirt in the carburettor or fuel line
	Throttle in the choke position
<b>Engine seems to have no power</b>	Air filter clogged
	Spark plug defective
	Dirt in the carburettor or fuel line
	Carburettor incorrectly set
	Throttle in the choke position
<b>Engine overheats</b>	Engine overloaded
	Spark plug defective
	Air intake or cooling flanges blocked
	Fan damaged
	Too little or no oil in engine
<b>Battery does not charge</b>	One or more battery cells faulty
	Poor contact on the battery terminal cable connectors
<b>Machine vibrates</b>	Blades are loose
	One or more blades unbalanced, caused by damage or poor balancing after sharpening
<b>Uneven mowing</b>	Blades blunt
	Long or wet grass
	Grass blockage under hood
	Different tyre pressures on right and left sides
	Over-speeding
	Engine speed too low
	Drive belt slipping

# Storage

## Winter storage

At the end of the season, or if the machine is going to stand idle for more than 30 days, it should immediately be made ready for storage. Fuel which is left to stand for long periods (30 days or more) can leave tacky deposits which can block the carburettor and interfere with the engine.

Fuel stabiliser is an acceptable alternative to avoid tacky deposits during storage. Add stabiliser to the fuel in the tank or the storage container. Always use the mixing ratios indicated by the manufacturer. Run the engine for at least 10 minutes after adding the stabiliser so that it will reach the carburettor. Do not empty the fuel tank and carburettor if stabiliser has been added.



**WARNING! Never store a machine with fuel in the tank indoors or in poorly ventilated spaces where fuel vapour can come in contact with open flames, sparks, or a pilot light such as in a boiler, hot water tank, clothes drier, etc. Exercise caution when handling fuel. It is highly inflammable, and careless use can cause serious injury and damage to property. Drain off the fuel in an approved container outdoors and well clear of naked flames. Never use petrol for cleaning purposes. Use degreasing agents and hot water instead.**

To prepare the machine for storage follow these instructions:

- 1 Carefully clean the machine, especially under the cutting unit. Touch-up paint damage to avoid rust.
- 2 Inspect the machine for worn or damaged parts and tighten loose screws and nuts.
- 3 Change the engine oil, and take care of the waste oil.
- 4 Empty the fuel tank. Start the engine and run it until the carburettor is emptied of fuel.
- 5 Remove the plugs and pour about a tablespoon of engine oil into each cylinder. Pull round the engine to distribute the oil and screw the plugs back on.
- 6 Grease all grease nipples, joints and axles.
- 7 Remove the battery. Clean it, charge it, and store it in a cool place.
- 8 Store the machine in a clean and dry place and cover it over for extra protection.

## Service

Low season is the most suitable time to perform a service or overhaul of the machine in order to ensure high function safety during high season.

When ordering spare parts state your machine's purchase year, model, type, and serial number.

Always use genuine parts.

An annual check-up by an authorised servicing dealer is a good way to ensure that your ride-on mower performs at its best the following season.

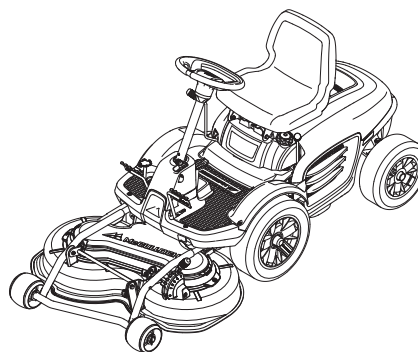

# TECHNICAL DATA

	M105-85F	M125-85FH
<b>Dimensions</b>		
Length with cutting unit, mm/ft	2057 / 6,75	2057 / 6,75
Width with cutting unit, mm/ft	1029 / 3,38	1029 / 3,38
Height, cm/in	107 / 42	107 / 42
Operating weight with cutting deck, kg/lb	190 / 419	190 / 419
Wheel base, mm/ft	800/2.62	800/2.62
Tyre size, front	16*6-10	16*6-10
Tyre size, back	13*5-8	13*5-8
Air pressure, rear - front, kPa / bar / PSI	150/1,5/22	150/1,5/22
<b>Engine</b>		
Brand / Model	Briggs & Stratton / 3105	Briggs & Stratton / 3125
Nominal engine output, kW (see note 1)	6,6	6,5
Displacement, cm <sup>3</sup> /cu.in	344/21	344/21
Max.motor speed, r/min	2900 ± 100	2900 ± 100
Fuel, minimum octane grade lead-free	85	85
Fuel tank capacity, litre	3,3	3,3
Oil, class SJ-CF	SAE 5W/30 or SAE 10W/30	SAE 5W/30 or SAE 10W/30
Oil tank capacity, litre/USqt	1,4/1,5	1,4/1,5
Starting	Electric starter	Electric starter
<b>Electrical system</b>		
Type	12 V, negative earthed	12 V, negative earthed
Battery	12 V, 18 Ah	12 V, 18 Ah
Spark plug	Champion QC12YC	Champion QC12YC
Electrode gap, mm/inch	0,75/0,030	0,75/0,030
Main fuse	Flat pin, 15 A.	Flat pin, 15 A.
<b>Noise emissions and cutting width</b> (see note 2)		
Sound power level, measured dB (A)	97	98
Sound power level, guaranteed dB(A)	98	99
Cutting width, cm/inch	85/33,5	85/33,5
<b>Sound levels</b> (see note 3)		
Sound pressure level at the operators ear, dB(A)	83	84
<b>Vibration levels</b> (see note 4)		
Vibration level on the steering wheel, m/s <sup>2</sup>	4,3	4,3
Vibration level in the seat, m/s <sup>2</sup>	1,3	1,3
<b>Transmission</b>		
Brand	Topec T7000	Tuff torq T36N
Lubricant	SAE 80W-90	SAE 10W/30
Number of forward gears	3	-
Number of reverse gears	1	-
Forward speed, km/h.	0-8	0-7,5
Reverse speed, km/h	0-4	0-7,5
<b>Cutting unit</b>		
Type	Mulching	Mulching
Cutting heights, 5 positions, mm/inch	25-70 / 1-2 3/4	25-70 / 1-2 3/4
Blade length, mm/inch	491 / 19,33	491 / 19,33

Note 1: The power rating of the engine indicated is the average net output (at specified rpm) of a typical production engine for the engine model measured to SAE standard J1349/ISO1585. Mass production engines may differ from this value. Actual power output for the engine installed on the final machine will depend on the operating speed, environmental conditions and other values.

Note 2: Noise emissions in the environment measured as sound power ( $L_{WA}$ ) in conformity with EC directive 2000/14/EC.

Note 3: Noise pressure level according to EN 836. Reported data for noise pressure level has a typical statistical dispersion (standard deviation) of 1.2 dB(A).

Note 4: Vibration level according to EN 836. Reported data for vibration level has a typical statistical dispersion (standard deviation) of 0.2 m/s<sup>2</sup> (steering wheel) and 0.8 m/s<sup>2</sup> (seat).

---

# TECHNICAL DATA

---

**IMPORTANT INFORMATION** When the service life of this product has been served and it is no longer used it should be returned to the dealer or to an applicable station for recycling.

**IMPORTANT INFORMATION** We reserve the right to change specifications and designs without prior notice so as to implement improvements. Note that no legal claims are valid on the basis of information in this manual. Use only genuine parts for repairs. The warranty is not valid if non genuine parts are used.

## EC-declaration of conformity (Applies to Europe only)

Husqvarna AB, SE-561 82 Huskvarna, Sweden, tel.: +46-36-146500, hereby declares that McCulloch M105-85F and M125-85FH from 2013's serial numbers and onwards (the year is clearly stated in plain text on the rating plate with subsequent serial number), complies with the requirements of the COUNCIL'S DIRECTIVE:

of May 17, 2006 "relating to machinery" **2006/42/EC**

of December 15, 2004 "relating to electromagnetic compatibility" **2004/108/EC**.

of May 8, 2000 "relating to the noise emissions in the environment" **2000/14/EC**.

Information regarding noise emissions and the mowing width, see Technical data

The following harmonised standards have been applied: **EN ISO 12100-2, EN-836**.

**0404, SMP Svensk Maskinprovning AB**, Fyrisborgsgatan 3, SE-754 50 Uppsala, has issued reports regarding the assessment of conformity according to annex VI of the COUNCIL'S DIRECTIVE of May 8, 2000 "relating to the noise emissions in the environment" 2000/14/EC.

The certificates have the numbers: 01/901/207, 01/901/208

Huskvarna January 3, 2013



Claes Losdal, Development Manager/Garden Products (Authorized representative for Husqvarna AB and responsible for technical documentation.)



**WWW.McCULLOCH.COM**

Original instructions

1155512-26



2013-01-11