

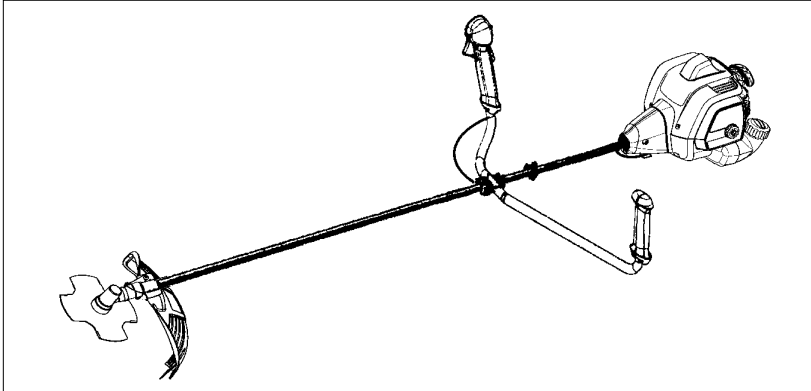

CABRIO 433B



GB

INSTRUCTION MANUAL

IMPORTANT INFORMATION: Please read these instructions carefully and make sure you understand them before using this unit. Retain these instructions for future reference.

FR

MANUEL D'INSTRUCTIONS

RENSEIGNEMENTS IMPORTANTS: Avant d'utiliser cet appareil, veuillez lire attentivement les instructions et assurez-vous de les avoir comprises. Conservez les instructions pour référence ultérieure.

DE

BETRIEBSANWEISUNG

WICHTIGE INFORMATION: Lesen Sie diese Hinweise zur Handhabung des Geräts aufmerksam durch. Verwenden Sie es erst, wenn Sie sicher sind, daß Sie alle Anweisungen verstanden haben und gut aufbewahren.

ES

MANUAL DE INSTRUCCIONES

INFORMACIÓN IMPORTANTE: Lea atentamente las instrucciones y asegúrese de entenderlas antes de utilizar esta aparato. Conserve las instrucciones para la referencia en el futuro.

TABLE OF CONTENTS

Identification (What is What?)	2	Service & Adjustments	13
Identification of Symbols	3	Storage	15
Safety Rules	3	Troubleshooting Table	16
Assembly	5	Declaration of Conformity	17
Operation	9	Technical Data	18
Maintenance	12		

IDENTIFICATION (WHAT IS WHAT?)

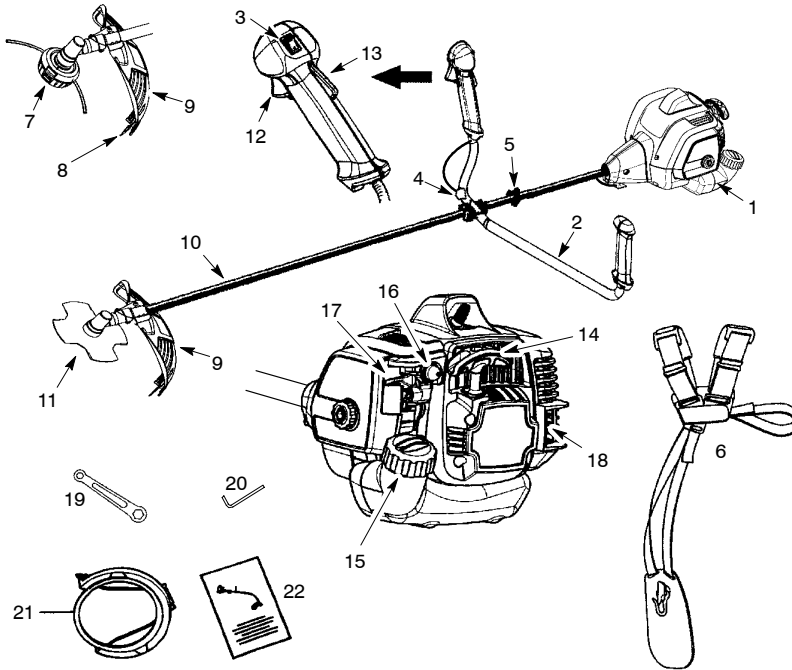

- | | |
|---------------------------|------------------------|
| 1. Fuel tank | 12. Throttle trigger |
| 2. Handlebar | 13. Throttle lock-out |
| 3. ON/STOP (I/O) switch | 14. Starter handle |
| 4. Throttle cable clip | 15. Fuel cap |
| 5. Shoulder harness clamp | 16. Primer bulb |
| 6. Shoulder harness | 17. Start lever |
| 7. Trimmer head | 18. Muffler |
| 8. Line limiter blade | 19. Wrench |
| 9. Combination shield | 20. Hex wrench |
| 10. Shaft | 21. Transport guard |
| 11. Blade | 22. Instruction manual |

IDENTIFICATION OF SYMBOLS

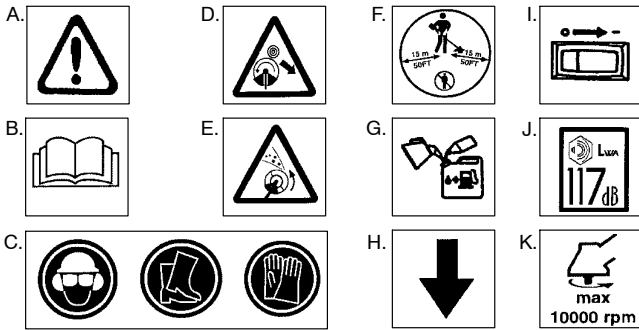

- A. **WARNING!** This brushcutter can be dangerous! Careless or improper use can cause serious or even fatal injury.
- B. Read and understand the instruction manual before using the brushcutter.
- C. Always use:
Ear protection, eye protection, head protection, boots, and gloves.
- D. **DANGER!** Blade can thrust violently away from material it does not cut. Blade thrust can cause amputation of arms or legs. Keep people and animals 15 meters away.
- E. **WARNING!** Blade/trimmer line can throw objects violently. You and others can be blinded or injured. Always wear eye protection and leg protection.
- F. The operator of the machine must insure that no one comes within a 15 meter radius while working. When several operators are working within the same area a safety distance of at least 15 meters must be observed.
- G. Use unleaded or quality leaded petrol and two-stroke oil mixed at a ratio of 2.5%.
- H. Handlebar to be positioned only below the arrow.
- I. Engine ON/STOP (I/O) Switch.
- J. Guaranteed sound power level according to Directive 2000/14/EC
- K. Maximum rotational frequency of the spindle, rpm

SAFETY RULES

⚠ WARNING: When using gardening appliances, basic safety precautions should always be followed to reduce the risk of fire and serious injury. Read and follow all instructions.

⚠ DANGER: *This power tool can be dangerous!* This unit can cause serious injury including amputation or blindness to the operator and others. The warnings and safety instructions in this manual must be followed to provide reasonable safety and efficiency in using the unit. The operator is responsible for following the warnings and instructions in this manual and on the unit. Read the entire instruction manual before assembling and using the unit! Restrict the use of this unit to persons who read, understand, and follow the warnings and instructions in this manual and on the unit. Never allow children to operate this unit.



INSTRUCTION
MANUAL



SAFETY INFORMATION
ON THE UNIT

⚠ DANGER: Blade can thrust violently away from material it does not cut. Blade thrust can cause amputation of arms or legs. Keep people and animals 15 meters away.



⚠ WARNING: Blade/trimmer line can throw objects violently. You and others can be blinded or injured. Wear safety glasses and leg protection.



⚠ WARNING: Hazard zone for thrown objects. Blade/Trimmer line can throw objects violently. Others can be blinded or injured. Keep people and animals 15 meters away.

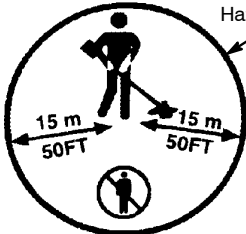

⚠ WARNING: Do not use trimmer head as a fastening device for the blade.



⚠ WARNING: The blade continues to spin after the throttle is released or, engine is turned off. The coasting blade can throw objects or seriously cut if accidentally touched. Stop the blade by contacting the right hand side of the coasting blade with material already cut.

Stop coasting blade by contact with cut material.

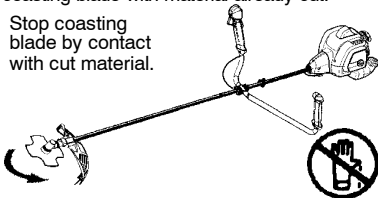

OPERATOR SAFETY

⚠ WARNING: This machine produces an electromagnetic field during operation. Under some circumstances, this field may interfere with active or passive medical implants. To reduce the risk of serious or fatal injury, we recommend persons with medical implants to consult their physician and the medical implant manufacturer before operating this machine.

- Dress properly. Always wear safety glasses or similar eye protection when operating, or performing maintenance, on your unit (safety glasses are available). Eye protection should be marked Z87.
- Always wear a helmet if the trees to be cleared are taller than 2 meters.
- Always wear face or dust mask if operation is dusty.
- Always wear heavy, long pants, long sleeves, boots, and gloves. Wearing safety leg guards is recommended.
- Always wear foot protection. Do not go barefoot or wear sandals. Stay clear of blade/spinning line.
- Secure hair above shoulder length. Secure or remove loose clothing or clothing with loosely hanging ties, straps, tassels, etc. They can be caught in moving parts.
- Being fully covered also helps protect you from debris and pieces of toxic plants thrown by spinning line.
- Stay alert. Do not operate this unit when you are tired, ill, upset or under the influence of alcohol, drugs, or medication. Watch what you are doing; use common sense.
- Wear hearing protection. Long or continuous exposure to high noise levels may cause permanent hearing impairment.
- Never start or run inside a closed room or building. Breathing exhaust fumes can kill.
- Keep handles free of oil and fuel.
- Always use the handlebar and a properly adjusted shoulder harness with a blade (see ASSEMBLY).

UNIT / MAINTENANCE SAFETY

- ⚠ WARNING:** Stop unit and disconnect the spark plug before performing maintenance (except carburetor adjustments).
- Throw away blades that are bent, warped, cracked, broken, or damaged in any other way. Replace trimmer head parts that are cracked, chipped, broken, or damaged in any other way before using the unit.
 - Maintain unit according to recommended procedures. Keep blade sharp. Keep cutting line at the proper length.
 - Use only 2,4 mm diameter McCulloch brand replacement line. Never use wire, rope, string, etc.
 - Install required shield properly before using the unit.
 - Use only specified blade or trimmer head; make sure it is properly installed and securely fastened.
 - Never start engine with clutch shroud removed. The clutch can fly off and cause serious injury.
 - Be sure blade or trimmer head stops turning when engine idles.
 - Make carburetor adjustments with the lower end supported to prevent blade or trimmer line from contacting any object. Hold unit by hand; do not use the shoulder harness for support.

- Keep others away when making carburetor adjustments.
- Use only recommended McCulloch accessories and replacement parts.
- Have all maintenance and service not explained in this manual performed by your authorized service dealer.

FUEL SAFETY

- Mix and pour fuel outdoors.
- Keep away from sparks or flames.
- Use a container approved for fuel.
- Do not smoke or allow smoking near fuel or the unit.
- Avoid spilling fuel or oil. Wipe up all fuel spills.
- Move at least 3 meters away from fueling site before starting engine.
- Stop engine and allow to cool before removing fuel cap.
- Always store petrol in a container approved for flammable liquids.

CUTTING SAFETY

⚠ WARNING: Inspect the area to be cut before each use. Remove objects (rocks, broken glass, nails, wire, string, etc.) which can be thrown or become entangled in the blade or trimmer head.

- Keep others including children, animals, bystanders, and helpers at least 50 feet (15 meters) away. Stop engine immediately if you are approached.
- Always keep engine on the right-hand side of your body.
- Hold the unit firmly with both hands.
- Keep firm footing and balance. Do not overreach.
- Keep blade or trimmer head below waist level. Do not raise engine above your waist.
- Keep all parts of your body away from blade, trimmer head, and muffler when engine is running. A hot muffler can cause serious burns.

- Cut from your left to your right. Cutting on right side of the shield will throw debris away from the operator.
- Use only in daylight or good artificial light.
- Use only for jobs explained in this manual.

TRANSPORTING AND STORAGE

- Allow the engine to cool; secure unit before storing or transporting in vehicle.
- Empty fuel tank before storing or transporting the unit. Use up fuel left in the carburetor by starting engine and letting it run until it stops.
- Store unit and fuel in an area where fuel vapors cannot reach sparks or open flames from water heaters, electric motors or switches, furnaces, etc.
- Store unit so line limiter cannot accidentally cause injury. Unit can be hung by the shaft.
- Always install transport guard on blade before transporting or storage.
- Store the unit out of the reach of children.
- Secure the machine during transport.

SPECIAL NOTICE: Exposure to vibrations through prolonged use of petrol powered hand tools could cause blood vessel or nerve damage in the fingers, hands, and joints of people prone to circulation disorders or abnormal swellings. Prolonged use in cold weather has been linked to blood vessel damage in otherwise healthy people. If symptoms occur such as numbness, pain, loss of strength, change in skin color or texture, or loss of feeling in the fingers, hands, or joints, discontinue the use of this tool and seek medical attention. An anti-vibration system does not guarantee the avoidance of these problems. Users who operate power tools on a continual and regular basis must monitor closely their physical condition and the condition of this tool.

ASSEMBLY

CARTON CONTENTS

Check carton contents against the following list:

- Brushcutter
- Blade
- Cupped washer
- Large nut for installing blade
- Trimmer head
- Combination shield
- Bolt
- Handlebar
- Handlebar bracket cover
- Handlebar bracket cover screws (2)
- Upper shoulder harness clamp
- Lower shoulder harness clamp
- Shoulder harness clamp screws (2)
- Shoulder harness
- Hex wrench
- Wrench
- Transport guard
- Throttle cable clip

⚠ WARNING: Always stop unit and disconnect spark plug before performing any assembly procedures.

⚠ WARNING: If received assembled, repeat all steps to ensure your unit is properly assembled and all fasteners are secure. Examine parts for damage. Do not use damaged parts. It is normal for the fuel filter to rattle in the empty fuel tank. Finding fuel or oil residue on muffler is normal due to carburetor adjustments and testing done by the manufacturer.

TOOLS REQUIRED

- Hex wrench (provided)
- Adjustable wrench
- Phillips screwdriver

ATTACHING THE HANDLEBAR

⚠ DANGER: To avoid serious injury, the barrier portion of the handlebar must be installed as shown to provide a barrier between operator and the spinning blade.

1. Remove the screw at the rear of the throttle handle.
2. Slide the throttle handle onto the right side of the handlebar (see illustration).
3. Align the screw hole in the throttle handle with the hole in the handlebar.
4. Refit the screw in the hole in the rear of the throttle handle.
5. Screw the screw through the handle and handlebar. Tighten the screw.
6. Fit the mounting components as shown.

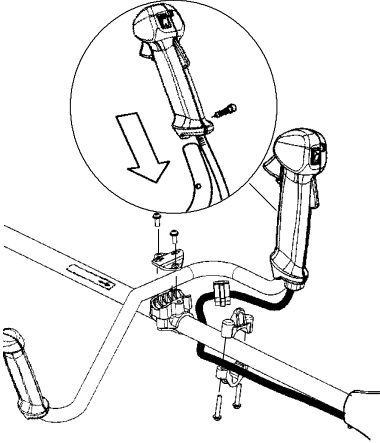

7. The handlebar mounting must be fitted above the arrow on the shaft.
8. Tighten the screws with a hex wrench.

ASSEMBLY OF SHOULDER HARNESS

⚠ WARNING: When using a brushcutter, it must always be hooked securely to the shoulder harness. Otherwise, you will be unable to safely control the brushcutter. This can result in injury to yourself or others. Proper shoulder harness and handlebar adjustments must be made with the engine completely stopped before using unit. A well-adjusted shoulder harness and machine makes work much easier.

ATTACHING SHOULDER HARNESS CLAMP (if not already attached)

1. Place the upper shoulder harness clamp over the shaft.

2. Position the lower shoulder harness clamp under the shaft and align the upper and lower clamp screw holes. Clamp must be fitted above the arrow on the shaft (see illustration above).

NOTE: Fit throttle wire in groove of lower harness clamp before tightening screws.

3. Insert two screws into the screw holes.
4. Secure shoulder harness clamp by tightening screws with a hex wrench.

SHOULDER HARNESS ADJUSTMENT

At the front of the shoulder harness is an easily accessible quick release. Use the quick release in any emergency situation that requires you to free yourself from the machine and harness.

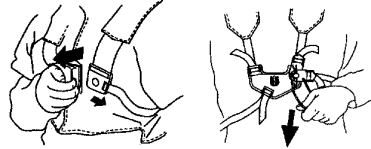

1. Put on the harness. Adjust the harness for the best working position.
2. Tension the side straps so that the weight is evenly distributed across both shoulders.



NOTE: It may be necessary to relocate the shoulder harness clamp on the shaft for proper balancing of unit.

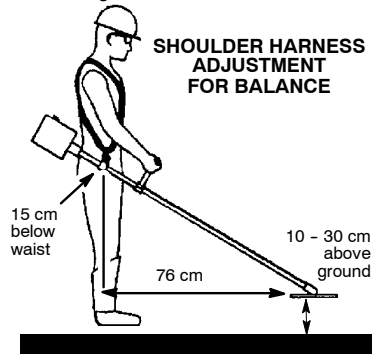

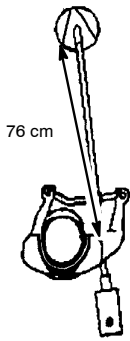

ATTACHING THE SHIELD

WARNING: The shield must be properly installed. The shield provides partial protection to the operator and others from the risk of thrown objects, and is equipped with a line limiter blade which cuts excess line to the proper length. The line limiter blade (on underside of shield) is sharp and can cut you.

1. Insert bracket into slot on shield.
2. Pivot shield to align holes in shield and bracket.

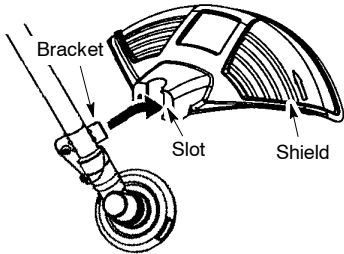

3. Secure shield to bracket with bolt.

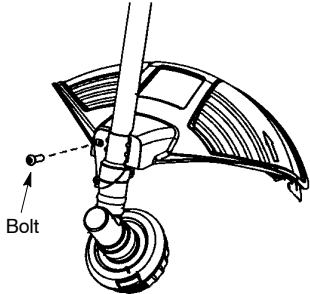

CONFIGURING YOUR UNIT

You can configure your unit using a cutting head for grass and light weeds, or a weed blade for cutting grass, weeds, and brush up to 1 cm in diameter. To assemble your unit, go to the section for the desired configuration and follow the instructions.

ASSEMBLY INFORMATION - TRIMMER HEAD

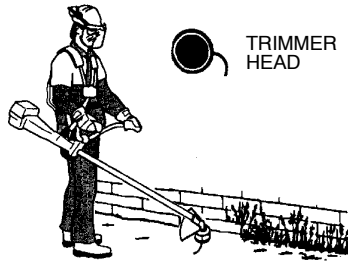

NOTE: Remove the blade before attaching the trimmer head. To remove blade, align hole in the dust cup with the hole in the side of the gearbox by rotating the blade. Insert a small screwdriver into aligned holes. This will keep the shaft from turning while loosening the blade nut. Remove blade nut by turning clockwise. Remove the screwdriver. Remove both washers and blade. See INSTALLATION OF THE METAL BLADE for illustrations. Be sure to store all parts and instructions for future use.

INSTALLATION OF THE TRIMMER HEAD

NOTE: If your unit has a plastic cover over the threads on the threaded shaft, remove the covering to expose the threads. Before installing the trimmer head, make sure the dust cup and retaining washer are positioned on the gearbox.

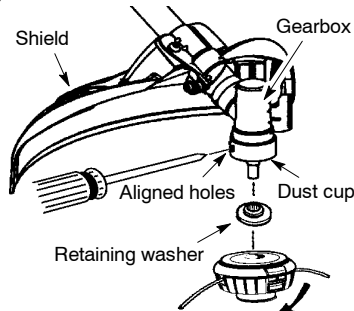

NOTE: Make sure all parts are properly installed as shown in the illustration before installing the trimmer head.

1. Align hole in the dust cup with the hole in the side of the gearbox by rotating the dust cup.
2. Insert a small screwdriver into aligned holes. This will keep the shaft from turning while tightening trimmer head.
3. While holding the screwdriver in position, thread trimmer head onto the shaft in the direction shown on the decal (counterclockwise). Tighten until secure.

NOTE: The retaining washer must be positioned with the raised section facing toward the gearbox.

ASSEMBLY INFORMATION - WEED BLADE

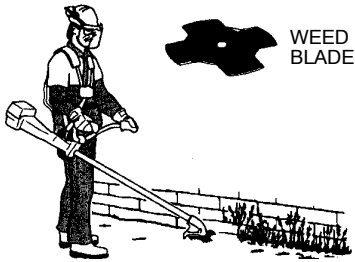

NOTE: Remove the trimmer head before installing the weed blade. To remove the trimmer head, align hole in the dust cup with the hole in the side of the gearbox by rotating the dust cup. Insert a small screwdriver into aligned holes. This will keep the shaft from turning while loosening the trimmer head. Remove the trimmer head by turning clockwise. Remove the screwdriver. See **INSTALLATION OF THE CUTTING HEAD** for illustrations. Be sure to store all parts and instructions for future use. Never use the trimmer head with the metal blade installed.

INSTALLATION OF THE METAL BLADE

WARNING: Wear protective gloves when handling or performing maintenance on the blade to avoid injury. The blade is sharp and can cut you even when it is not moving.

WARNING: Do not use any blades, or fastening hardware other than the washers and nuts shown in the following illustrations. These parts must be provided by McCulloch and installed as shown below. Failure to use proper parts can cause the blade to fly off and seriously hurt you or others.

NOTE: The dust cup is located on the gearbox shaft and not in the parts bag. All other fasteners mentioned in the following assembly steps are in the parts bag.

1. Install the blade and the retaining washer over the threaded shaft.
2. Make sure the raised part of the retaining washer is facing the gearbox and the raised area fits into the hole in the center of the blade.
3. Slide the blade and retaining washer onto the shaft of the gearbox.
4. Place the cupped washer onto the shaft. Make sure the cupped side of the washer is toward the blade.
5. Install the blade nut by threading onto the shaft counterclockwise.

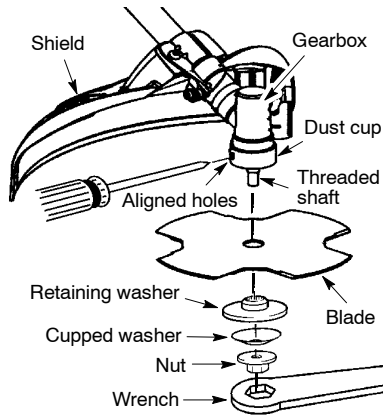

NOTE: Make sure all parts are in place as illustrated, and the blade is sandwiched between the dust cup and the retaining washer. There should be no space between the blade and the dust cup or the retaining washer.

6. Align hole in dust cup with hole in side of gearbox by rotating the blade.
7. Insert a small screwdriver into aligned holes. This will keep the shaft from turning while tightening the blade nut.
8. Tighten blade nut firmly with a wrench (provided) while holding screwdriver in position.
9. Remove the screwdriver.
10. Turn blade by hand. If the blade binds against the shield, or appears to be uneven, the blade is not centered, and you must reinstall.

NOTE: To remove blade, insert screwdriver into aligned holes. Unthread the nut and remove parts. Be sure to store parts and instructions for future use.

ATTACHING THE TRANSPORT GUARD

NOTE: The transport guard must always be attached to the blade when the machine is being transported or in storage.

1. Remove ends of wire retainer from the clips on the transport guard.
2. Lift wire retainer and position blade in transport guard.
3. Place wire retainer over blade and insert both ends of wire retainer back into clips.

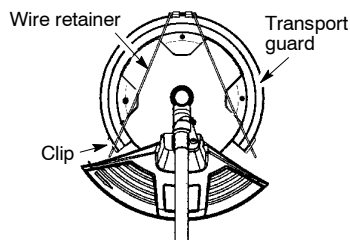

OPERATION

WARNING: Be sure to read the fuel information in the safety rules before you begin. If you do not understand the safety rules, do not attempt to fuel your unit. Contact an authorized service dealer.

FUELING ENGINE

WARNING: Remove fuel cap slowly when refueling.

This engine is certified to operate on unleaded petrol. Before operation, petrol must be mixed with a good quality 2-cycle air-cooled engine oil designed to be mixed at a ratio of 40:1. A 40:1 ratio is obtained by mixing 5 liters of unleaded petrol with 0,125 liter of oil. **DO NOT USE** automotive oil or marine oil. These oils will cause engine damage. When mixing fuel, follow instructions printed on oil container. Once oil is added to petrol, shake container momentarily to assure that the fuel is thoroughly mixed. Always read and follow the safety rules relating to fuel before fueling your unit.

CAUTION: Never use straight petrol in your unit. This will cause permanent engine damage.

FUEL REQUIREMENTS

Use good quality unleaded petrol. The lowest recommended octane grade is 90 (RON).

IMPORTANT

Use of alcohol blended fuels (more than 10% alcohol) can cause major engine performance and durability problems.

WARNING: Incorrect use of fuel and/or lubricants will cause problems such as: improper clutch engagements, overheating, vapor lock, power loss, lubrication deficiency, deterioration of fuel lines, gaskets and internal carburetor components, etc. Alcohol blended fuels will cause a high absorption of moisture in the fuel/oil mixture, causing the separation of oil and fuel.

HOW TO STOP YOUR UNIT

- To stop the engine, move the ON/STOP (I/O) switch to the STOP (O) position.

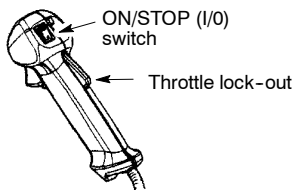

HOW TO START YOUR UNIT

WARNING: Avoid any contact with the muffler. A hot muffler can cause serious burns.

STARTING A COLD ENGINE (or a warm engine after running out of fuel)

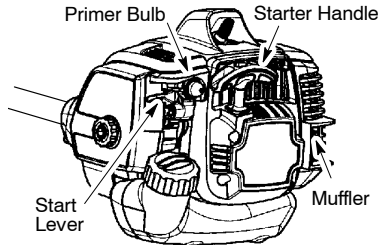
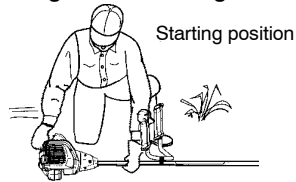

NOTE: The throttle lock-out is designed to prevent unintentional use of the throttle trigger. The lock-out must be pressed with the palm of your hand as you grip the throttle handle before the trigger can be used. **DO NOT** squeeze the throttle trigger until the engine has started and runs.

1. Set unit on a flat surface.
2. Move ON/STOP (I/O) switch to the ON (I) position.
3. Slowly press the primer bulb 6 times.
4. Move the start lever to the START position.
5. Pull starter rope handle sharply until engine starts and runs.
6. Allow unit to run for 10-15 seconds, then fully squeeze the throttle trigger to disengage the starting system.

STARTING A WARM ENGINE

1. Move ON/STOP (I/O) switch to the ON (I) position.
2. Pull starter rope sharply until engine starts and runs.

NOTE: Normally, the warm starting procedure can be used within 5 - 10 minutes after the unit is turned off. If the unit sits for more than 10 minutes without being run, it will be necessary to start the unit by following the steps under STARTING A COLD ENGINE or following the starting instruction steps shown on the unit.

STARTING A FLOODED ENGINE

Move the start lever to the RUN position and fully squeeze throttle trigger. Pull the starter handle repeatedly while squeezing throttle trigger until engine starts and runs. This could require pulling the starter handle many times, depending on how badly the unit is flooded. If the unit still doesn't start, refer to TROUBLE-SHOOTING TABLE.

OPERATING POSITION

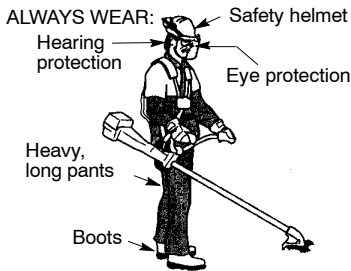

Cut from your left to your right.

When operating unit, clip shoulder harness onto clamp, stand as shown and check for the following:

- Wear eye protection and heavy clothing.
- Extend your left arm and hold handlebar grip with your left hand.
- Hold throttle grip with your right hand with finger on throttle trigger.
- Keep unit below waist level.
- Maintain full weight of tool on both shoulders.
- Without bending over, keep the blade or trimmer head near and parallel to the ground and not crowded into material being cut.

OPERATING INSTRUCTIONS FOR USE WITH TRIMMER HEAD

WARNING: Always wear eye protection. Never lean over the trimmer head. Rocks or debris can ricochet or be thrown into eyes and face and cause blindness or other serious injury.

Before trimming, bring engine to a speed sufficient to cut material to be trimmed.

Do not run the engine at a higher speed than necessary. The cutting line will cut efficiently when the engine is run at less than full throttle. At lower speeds, there is less engine noise and vibration. The cutting line will last longer and will be less likely to "weld" onto the spool.

Always release the throttle trigger and allow the engine to return to idle speed when not cutting.

To stop engine:

- Release the throttle trigger.
- Move ON/STOP (I/O) switch to the STOP (0) position.

TRIMMER LINE ADVANCE

Advance line by tapping the bottom of the cutting head lightly on the ground while engine is running at full speed. The metal line limiter blade attached to the guard will cut the line to the proper length.

WARNING: Use only 2,4 mm diameter line. Other sizes of line will not advance properly and can cause serious injury. Do not use other materials such as wire, string, rope, etc. Wire

can break off during cutting and become a dangerous missile that can cause serious injury.

CUTTING METHODS

WARNING: Use minimum speed and do not crowd the line when cutting around hard objects (rock, gravel, fence posts, etc.), which can damage the trimmer head, become entangled in the line, or be thrown causing a serious hazard.

- The tip of the line does the cutting. You will achieve the best performance and minimum line wear by not crowding the line into the cutting area. The right and wrong ways are shown below.

Tip of line does the cutting.

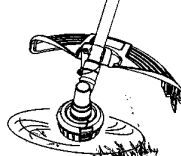

Right

Line crowded into work area.

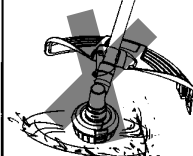

Wrong

- The line will easily remove grass and weeds from around walls, fences, trees and flower beds, but it also can cut the tender bark of trees or shrubs and scar fences.
- For trimming or scalping, use less than full throttle to increase line life and decrease head wear, especially:
 - During light duty cutting.
 - Near objects around which the line can wrap such as small posts, trees or fence wire.
- For mowing or sweeping, use full throttle for a good clean job.

TRIMMING - Hold the bottom of the trimmer head about 8 cm above the ground and at an angle. Allow only the tip of the line to make contact. Do not force trimmer line into work area.

Trimming

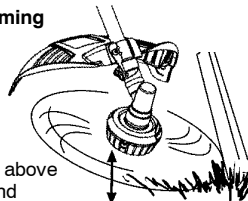

8 cm above ground

SCALPING - The scalping technique removes unwanted vegetation down to the ground. Hold the bottom of the trimmer head about 8 cm above the ground and at an angle. Allow the tip of the line to strike the ground around trees, posts, monuments, etc. This technique increases line wear.

Scalping

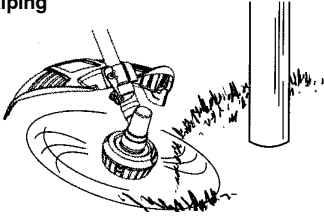

MOWING - Your trimmer is ideal for mowing in places conventional lawn mowers cannot reach. In the mowing position, keep the line parallel to the ground. Avoid pressing the head into the ground as this can scalp the ground and damage the tool.

Mowing

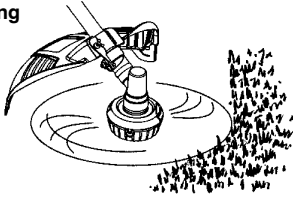

SWEEPING - The fanning action of the rotating line can be used to blow away loose debris from an area. Keep the line parallel to and above the area surface and swing the tool from side to side.

Sweeping

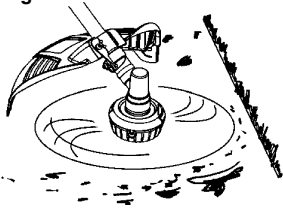

OPERATING INSTRUCTIONS FOR USE WITH WEED BLADE

- **Blade Thrust** is a reaction that only occurs when using a bladed unit. This reaction can cause serious injury such as amputation. Carefully study this section. It is important that you understand what causes blade thrust, how you can reduce the chance of its occurring, and how you can remain in control of unit if blade thrust occurs.
- **WHAT CAUSES BLADE THRUST - Blade Thrust** can occur when the spinning blade contacts an object that it does not cut. This contact causes the blade to stop for an instant and then suddenly move or "thrust" away from the object that was hit. The "thrusting" reaction can be violent enough to cause the operator to be propelled in any direction and lose control of the unit. The uncontrolled unit can cause serious injury if the blade contacts the operator or others.

- **WHEN BLADE THRUST OCCURS - Blade Thrust** can occur without warning if the blade snags, stalls, or binds. This is more likely to occur in areas where it is difficult to see the material being cut. By using the unit properly, the occurrence of blade thrust will be reduced and the operator will be less likely to lose control.



- Cut only grass, weeds, and woody brush up to 1 cm in diameter with the weed blade. Do not let the blade contact material it cannot cut such as stumps, rocks, fences, metal, etc., or clusters of hard, woody brush having a diameter greater than 1 cm.
 - Keep the blade sharp. A dull blade is more likely to snag and thrust.
 - Cut only at full throttle. The blade will have maximum cutting power and is less likely to bind or stall.
 - "Feed" the blade deliberately and not too rapidly. The blade can thrust away if it is fed too rapidly.
 - Cut only from your left to your right. Cutting on right side of the shield will throw debris away from the operator.
 - Use the shoulder harness and keep a firm grip on the unit with both hands. A properly adjusted shoulder harness will support the weight of the unit, freeing your arms and hands to control and guide the cutting motion.
 - Keep feet comfortably spread apart and braced for a possible sudden, rapid thrust of unit. Do not overreach. Keep firm footing and balance.
 - Keep blade below waist level; it will be easier to maintain control of unit.
 - Do not raise the engine above your waist as the blade can come dangerously close to your body.
 - Do not swing unit with such force that you are in danger of losing your balance.
- Bring the engine to cutting speed before entering the material to be cut. If the blade does not turn when you squeeze the throttle trigger, make sure shaft is fully inserted into the engine. Always release the throttle trigger and allow engine to return to idle speed when not cutting. The blade should not turn while the engine is running at idle. If the blade turns at idle, do not use your unit. Refer to the CARBURETOR ADJUSTMENT section or contact your authorized service dealer.
- Maintain good firm footing while using the unit. Do this by planting feet firmly in a comfortable apart position.
 - Cut while swinging the upper part of your body from left to right.

- As you move forward to the next area to cut, be sure to maintain your balance and footing.

RECOMMENDED CUTTING POSITION

Cut using the 2 o'clock to 4 o'clock position of the blade

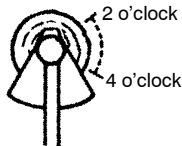

⚠ WARNING: The operator or others must not try to clear away cut material with the engine running or the blade turning to avoid serious injury. Stop engine and blade before removing materials wrapped around blade or shaft.

MAINTENANCE

The life span of the machine can be reduced and the risk of accidents can increase if machine maintenance is not carried out correctly and if service and/or repairs are not carried out professionally. If you need further information, please contact your nearest authorised service dealer.

⚠ WARNING: Disconnect the spark plug before performing maintenance except for carburetor adjustments.

CHECK FOR LOOSE FASTENERS AND PARTS

- Spark Plug Boot
- Air Filter
- Housing Screws
- Handlebar Screws
- Combination Shield

CHECK FOR DAMAGED OR WORN PARTS

Contact an authorized service dealer for replacement of damaged or worn parts.

- ON/STOP (I/O) Switch - Ensure ON/STOP (I/O) switch functions properly by moving the switch to the STOP (O) position. Make sure engine stops; then restart engine and continue.
- Fuel Tank - Discontinue use of unit if fuel tank shows signs of damage or leaks.
- Combination Shield - Discontinue use of unit if shield is damaged.

INSPECT AND CLEAN UNIT AND LABELS

- After each use, inspect complete unit for loose or damaged parts. Clean the unit and labels using a damp cloth with a mild detergent.
- Wipe off unit with a clean dry cloth.

CLEAN AIR FILTER

A dirty air filter decreases engine performance and increases fuel consumption and harmful emissions. Always clean after every 5 hours of operation.

1. Clean the cover and the area around it to keep dirt from falling into the carburetor chamber when the cover is removed.
2. Remove parts as illustrated.

NOTE: Do not clean filter in petrol or other flammable solvent to avoid creating a fire hazard or producing harmful evaporative emissions.

3. Wash the filter in soap and water.
4. Allow filter to dry.
5. Replace parts.

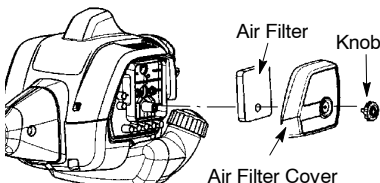

REPLACE SPARK PLUG

Replace the spark plug each year to ensure the engine starts easier and runs better. Set spark plug gap at 0.6 mm. Ignition timing is fixed and nonadjustable.

1. Twist, then pull off spark plug boot.
2. Remove spark plug from cylinder and discard.
3. Replace with Champion RCJ-6Y spark plug and tighten securely with a 19 mm socket wrench.
4. Reinstall the spark plug boot.

SERVICE AND ADJUSTMENTS

REPLACING THE LINE

1. Press the tabs on the side of the trimmer head and remove cover and spool.

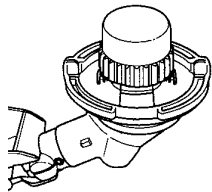
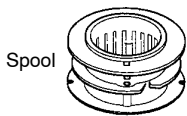
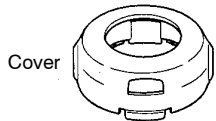
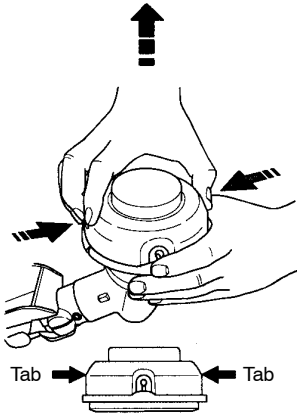

2. Remove any remaining line.
3. Clean dirt and debris from all parts. Replace spool if it is worn or damaged.
4. Replace with a pre-wound spool, or replace line using a 4,5 meters length of 2,4 mm diameter McCulloch brand line.

⚠ WARNING: Never use wire, rope, string, etc., which can break off and become a dangerous missile.

5. When installing new line on an existing spool, hold the spool as shown.

6. Bend the line at the midpoint and insert the bend into the slot in the center rim of the spool. Ensure line snaps into position in the slot.

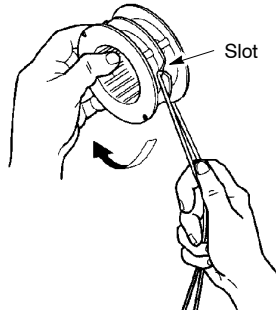

7. With your finger between the lines, wrap the lines evenly and firmly around the spool in a clockwise direction.

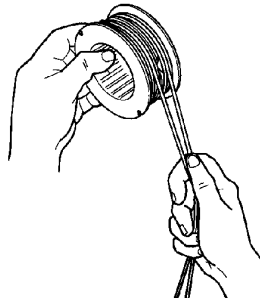

8. Position the lines in the guide slots.

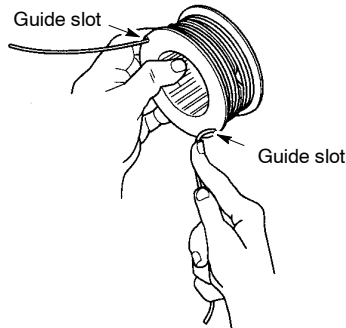

9. Place the spool in the cover as shown below.

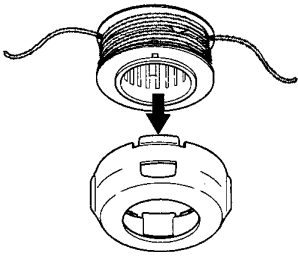

10. Insert the ends of the lines through exit holes in the sides of the cover.

Line exit hole

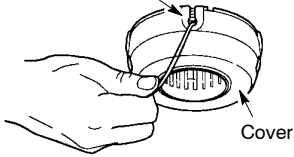

11. Reinstall the spool and cover onto the trimmer head. Push until cover snaps into place.

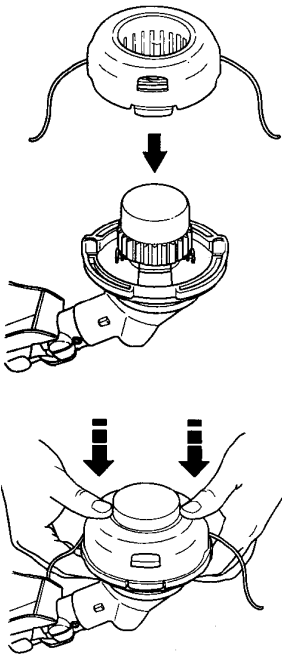

BLADE REPLACEMENT

Refer to the ASSEMBLY section for blade replacement instructions and illustrations.

CARBURETOR ADJUSTMENT

⚠ WARNING: Keep others away when making idle speed adjustments. The trimmer head will be spinning during most of this procedure. Wear your protective equipment and observe all safety precautions. After making adjustments, the trimmer head must not move/spin at idle speed.

The carburetor has been carefully set at the factory. Adjustments may be necessary if you notice any of the following conditions:

- Engine will not idle when the throttle is released.
- The trimmer head moves/spins at idle speed. Make adjustments with the unit supported so the cutting attachment is off the ground and will not make contact with any object. Hold the unit by hand while running and making adjustments. Keep all parts of your body away from the cutting attachment and muffler.

Idle Speed Adjustment

Allow engine to idle. Adjust speed until engine runs without trimmer head moving or spinning (idle speed too fast) or engine stalling (idle speed too slow).

- Turn idle speed screw clockwise to increase engine speed if engine stalls or dies.
- Turn idle speed screw counterclockwise to decrease engine speed if trimmer head moves or spins at idle speed.

⚠ WARNING: Recheck the idle speed after each adjustment. The trimmer head must not move or spin at idle speed to avoid serious injury to the operator or others.

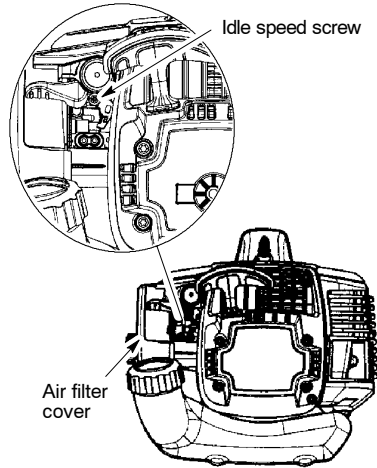

If you require further assistance or are unsure about performing this procedure, contact an authorized service dealer.

STORAGE

⚠ WARNING: Perform the following steps after each use:

- Allow engine to cool before storing or transporting.
- Store unit and fuel in a well ventilated area where fuel vapors cannot reach sparks or open flames from water heaters, electric motors or switches, furnaces, etc.
- Empty fuel tank before storing or transporting the unit.
- Store unit and fuel well out of the reach of children.
- Store unit with all guards in place. Position unit so that any sharp object cannot accidentally cause injury.

SEASONAL STORAGE

Prepare unit for storage at end of season or if it will not be used for 30 days or more.

If your unit is to be stored for a period of time:

- Clean the entire unit before lengthy storage.
- Store in a clean dry area.
- Lightly oil external metal surfaces.

ENGINE

- Remove spark plug and pour 1 teaspoon of 40:1, 2-cycle engine oil (air cooled) through the spark plug opening. Slowly pull the starter rope 8 to 10 times to distribute oil.
- Replace spark plug with new one of recommended type and heat range.
- Clean air filter.
- Check entire unit for loose screws, nuts, and bolts. Replace any damaged, broken, or worn parts.
- At the beginning of the next season, use only fresh fuel having the proper petrol to oil ratio.

OTHER

- Do not store petrol from one season to another.
- Replace your petrol can if it starts to rust.

TROUBLESHOOTING TABLE

⚠ WARNING: Always stop unit and disconnect spark plug before performing all of the recommended remedies below except remedies that require operation of the unit.

TROUBLE	CAUSE	REMEDY
Engine will not start.	<ol style="list-style-type: none"> 1. ON/STOP (I/O) switch in STOP position. 2. Engine flooded. 3. Fuel tank empty. 4. Spark plug not firing. 5. Fuel not reaching carburetor. 6. Carburetor requires adjustment. 	<ol style="list-style-type: none"> 1. Move ON/STOP (I/O) switch to ON (I) position. 2. See "Starting a Flooded Engine" in Operation Section. 3. Fill tank with correct fuel mixture. 4. Install new spark plug. 5. Check for dirty fuel filter; replace. Check for kinked or split fuel line; repair or replace. 6. Contact an authorized service dealer.
Engine will not idle properly.	<ol style="list-style-type: none"> 1. Carburetor requires adjustment. 2. Crankshaft seals worn. 3. Compression low. 	<ol style="list-style-type: none"> 1. See "Carburetor Adjustment" in Service and Adjustments Section. 2. Contact an authorized service dealer. 3. Contact an authorized service dealer.
Engine will not accelerate, lacks power, or dies under a load.	<ol style="list-style-type: none"> 1. Air filter dirty. 2. Spark plug fouled. 3. Carburetor requires adjustment. 4. Carbon build-up on muffler outlet screen. 5. Compression low. 	<ol style="list-style-type: none"> 1. Clean or replace air filter. 2. Clean or replace plug and regap. 3. Contact an authorized service dealer. 4. Contact an authorized service dealer. 5. Contact an authorized service dealer.
Engine smokes excessively.	<ol style="list-style-type: none"> 1. Choke partially on. 2. Fuel mixture incorrect. 3. Air filter dirty. 4. Carburetor requires adjustment. 	<ol style="list-style-type: none"> 1. Adjust choke. 2. Empty fuel tank and refill with correct fuel mixture. 3. Clean or replace air filter. 4. Contact an authorized service dealer.
Engine runs hot.	<ol style="list-style-type: none"> 1. Fuel mixture incorrect. 2. Spark plug incorrect. 3. Carburetor requires adjustment. 4. Carbon build-up on muffler outlet screen. 	<ol style="list-style-type: none"> 1. Empty fuel tank and refill with correct fuel mixture. 2. Replace with correct spark plug. 3. Contact an authorized service dealer. 4. Contact an authorized service dealer.

DECLARATION OF CONFORMITY

EC Declaration of Conformity (Only applies to Europe)

We, **Husqvarna AB**, SE-561 82 Huskvarna, Sweden, tel: +46-36-146500, as authorised representative in the Community, declare that the brushcutter model **McCulloch Cabrio 433B** with serial numbers dating from 2009 and onwards (the year is clearly stated on the rating plate, followed by the serial number), comply with the requirements of the **COUNCIL'S DIRECTIVES**:

of 17 May 2006 "relating to machinery" **2006/42/EC**;

of 15 December 2004 "relating to electromagnetic compatibility" **2004/108/EC**, and applicable supplements; and

of 8 May 2000 "relating to the noise emissions in the environment" in accordance with Annex V of **2000/14/EC**. For information relating to noise emissions, see Technical data section.

The following standards have been applied: **EN ISO 12100-1/A1:2009**, **EN ISO 12100-2/A1:2009**, **CISPR 12:2007**, **EN 11806:2008**.

SMP, The Swedish Machinery Testing Institute, Fyrisborgsgatan 3 S-754 50 Uppsala, Sweden, has performed voluntary type examination on behalf of Husqvarna AB. The certificate(s) are numbered: **SEC/09/2034**.

09-11-01



Ronnie E. Goldman, Director of Engineering
Authorized representative for Husqvarna AB and
responsible for technical documentation

TECHNICAL DATA SHEET

MODEL: Cabrio 433B

ENGINE

Cylinder displacement, cm ³	33
At maximum engine power, rpm	7000
Maximum rotational frequency of the spindle	10000
Engine speed at recommended maximum spindle rotational frequency	7400
Recommended speed idling, rpm	2900
Maximum engine power, measured in accordance with ISO 8893, kW	0,9

IGNITION SYSTEM

Spark plug	Champion RCJ-6Y
Electrode gap, mm	0,6

FUEL AND LUBRICATION SYSTEM

Fuel tank capacity, cm ³	480
-------------------------------------	-----

WEIGHT

Weight without fuel, cutting attachment and guard, kg	6,8
---	-----

NOISE EMISSIONS

(see Note 1)

Sound power level, measured dB(A)	112,3
Sound power level, guaranteed L _{WA} dB(A)	117,0

NOISE LEVELS

(see Note 2)

Equivalent sound pressure level at the operators' ear, measured according to EN/ISO 11806 and ISO 22868, dB(A)	
Equipped with grass blade (original)	102,0
Equipped with trimmer head (original)	99,8

VIBRATION LEVELS

(see Note 3)

Equivalent vibration levels (a _{h,eq}) at handles, measured according to EN ISO 11806 and ISO 22867, m/s ²	
Equipped with grass blade (original), left/right	6,7/5,1
Equipped with trimmer head (original), left/right	4,0/3,6

Note 1: Noise emissions in the environment measured as sound power (L_{WA}) in conformity with EC directive 2000/14/EC. Reported sound power level for the machine has been measured with the original cutting attachment that gives the highest level. The difference between guaranteed and measured sound power is that the guaranteed sound power also includes dispersion in the measurement result and the variations between different machines of the same model according to Directive 2000/14/EC.

Note 2: Reported data for equivalent sound pressure level for the machine has a typical statistical dispersion (standard deviation) of 1 dB(A).

Note 3: Reported data for equivalent vibration level has a typical statistical dispersion (standard deviation) of 1 m/s².

Model Cabrio 433B (3/8 LH arbor shaft thread)		
Centre hole in blades/cutters, Ø 25,4 mm		
Approved accessories	Type	Cutting attachment /guard, part. no.
Grass blade/grass cutter	Grass (Ø 20 cm, 4-teeth)	530 05 58 92 / 575 35 27 01
Trimmer head	TNG7 (Ø 2,4 mm line)	537 41 92-02 / 575 35 27 01