

Husqvarna

40cm Petrol Wheeled Rotary Lawnmower

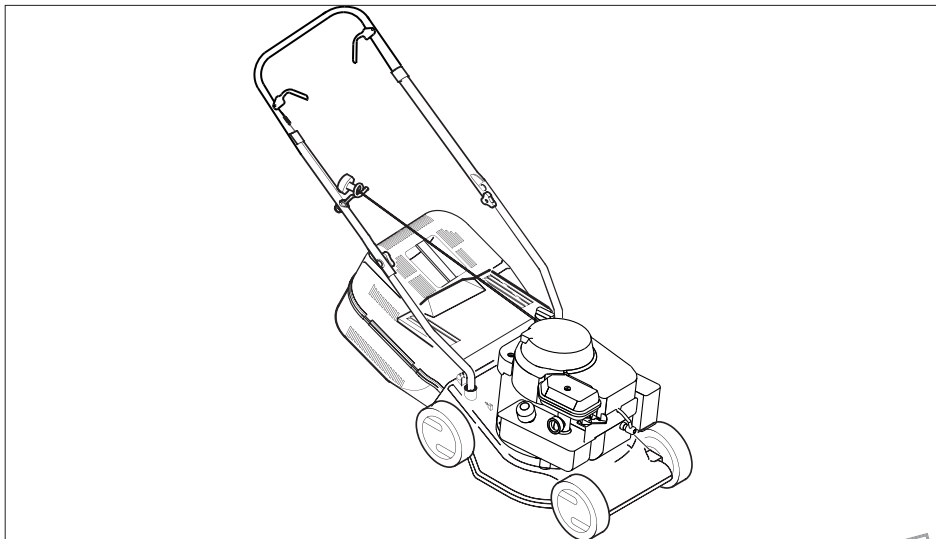

Original Instructions



IMPORTANT INFORMATION
Read before use
& retain for future reference

For all customer enquiries or for replacement parts, contact:-



01325 300303



www.flymo.com



customer.services@husqvarna.co.uk

Carton Contents

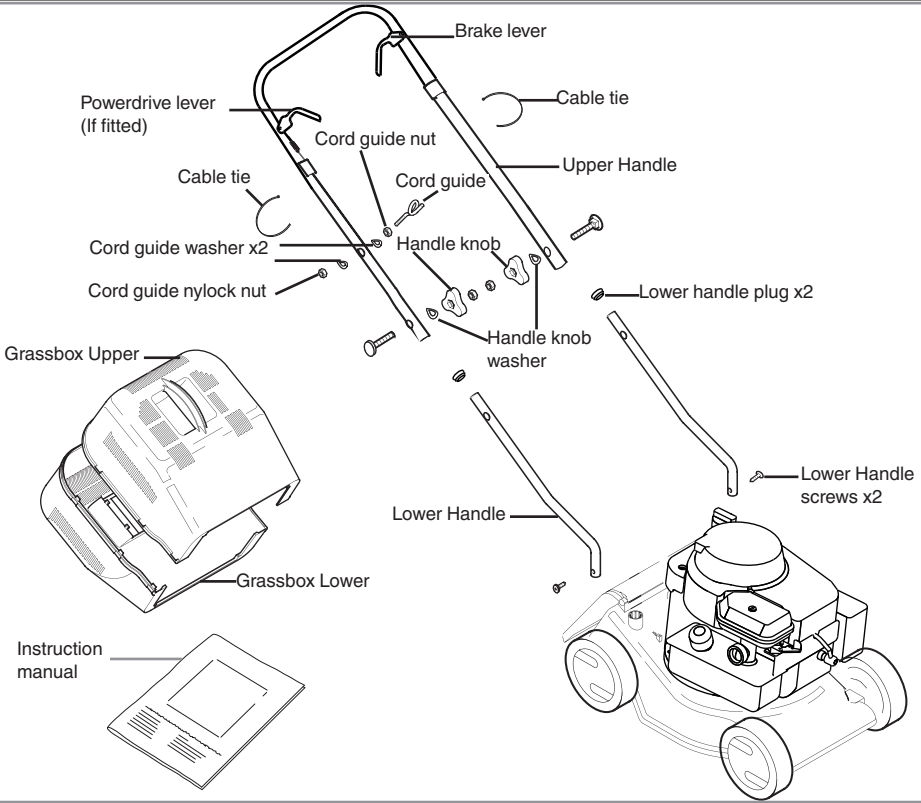

IMPORTANT!

Please check the contents of the carton are correct **BEFORE** assembling your new Flymo product.
IF ANY PARTS ARE MISSING CONTACT:- Husqvarna UK Ltd. Customer Service Department direct
 Telephone : 01325 300303 Fax : 01325 302530

Explanation of Symbols on your product



Warning



Read the user instructions carefully to make sure you understand all the controls and what they do.



Always keep the product on the ground when operating. Tilting or lifting the product may cause stones to be thrown out. Keep bystanders away. Do not mow whilst people especially children or pets are in the area.



Beware of severing toes or hands.



Do not put hands or feet near a rotating blade.



Risk of breathing in toxic gases! Do not use the appliance in closed or poorly ventilated environments.



Risk of explosion! Do not top up with fuel with engine running



Caution! Hot surface



Disconnect the spark plug before attempting any maintenance, cleaning or adjustment, or if you are going to leave the lawnmower unattended for any period.

Safety Precautions



If not used properly this lawnmower can be dangerous! This lawnmower can cause serious injury to the operator and others, the warnings and safety instructions must be followed to ensure reasonable safety and efficiency in using this lawnmower. The operator is responsible for following the warning and safety instructions in this manual and on the lawnmower. Never use the mower unless the grassbox or guards provided by the manufacturer are in the correct position.

General

1. Read the instructions carefully. Be familiar with the controls and the proper use of the equipment.
2. Never allow children or people unfamiliar with these instructions to use the mower. Local regulations may restrict the age of the operator.
3. Never mow while people, especially children, or pets are nearby.
4. Only use the lawnmower in the manner and for the functions described in these instructions.
5. Never operate the lawnmower when you are tired, ill or under the influence of alcohol, drugs or medicine.
6. The operator or user is responsible for accidents or hazards occurring to other people or their property.

Fuel Safety

WARNING - Petrol is highly flammable

- Wear protective clothing when handling any fuels and lubricants.
- Avoid contact with skin. If affected, wash liberally with soap and water.
- Remove petrol and engine oil before transporting the product.
- Store fuel in a cool place in a container specifically designed for the purpose.
- refuel outdoors only and do not smoke while refuelling
- add fuel **BEFORE** starting the engine. Never remove the cap of the fuel tank or add fuel while the engine is running or when the engine is hot
- if petrol is spilled, do not attempt to start the engine but move the machine away from the area of spillage and avoid creating any source of ignition until petrol vapours have dissipated
- replace all fuel tanks and container caps securely
- move the product away from the fuelling area before starting
- Fuel should be stored in a cool place away from naked flames

Preparation

1. While mowing, always wear substantial footwear and long trousers. Do not operate the equipment when barefoot or wearing open sandals.
2. The use of ear protection is recommended.
3. Make sure the lawn is clear of sticks, stones, bones, wire and debris; they could be thrown by the blade.
4. Before using the machine and after any impact, check for signs of wear or damage and repair as necessary.
5. Replace worn or damaged blades together with their fixings in sets to preserve balance.
6. Have faulty silencers replaced.

Use

1. Caution - Do not touch rotating blade.
2. Do not operate the engine in a confined space where exhaust fumes (carbon monoxide) can collect.
3. Use the lawnmower only in daylight or good artificial light.
4. Avoid operating your lawnmower in wet grass, where feasible.
5. Take care in wet grass, you may lose your footing.
6. On slopes, be extra careful of your footing.
7. Mow across the face of slopes, never up and down.
8. Exercise extreme caution when changing direction on slopes.

9. Mowing on banks and slopes can be dangerous. Do not mow on **banks** or excessively **steep** slopes.
10. Do not walk backwards when mowing, you could trip. Walk never run.
11. Never cut grass by pulling the mower towards you.
12. Release the brake lever to stop the engine before pushing the mower across surfaces other than grass and when transporting the lawnmower to and from the area to be mowed.
13. Never operate the lawnmower with damaged guards or without guards in place.
14. Do not overspeed the engine or alter governor settings. Excessive speed is dangerous and shortens lawnmower life.
15. Disengage all blade and drive clutches before starting.
16. Keep hands and feet away from the cutting means at all times and especially when switching on the engine.
17. Do not tilt lawnmower when starting the engine.
18. Never pick up or carry a lawnmower while the engine is running
19. Spark plug wire may be hot - handle with care.
20. Do not attempt any maintenance on your lawnmower when the engine is hot.
21. Release the brake lever, to stop the engine, and wait until the blade has stopped:-
 - before leaving the mower unattended for any period.
22. Release the brake lever, to stop the engine, wait until the blade has stopped and disconnect the spark plug lead and wait until the engine has cooled:-
 - whenever you leave the lawnmower;
 - before refuelling;
 - before clearing a blockage or unclogging chute
 - before checking, cleaning or working on the lawnmower;
 - if you hit an object. Do not use your lawnmower until you are sure that the entire lawnmower is in a safe operating condition;
 - if the lawnmower starts to vibrate abnormally. Check immediately. Excessive vibration can cause injury.

Maintenance and storage

1. Keep all nuts, bolts and screws tight to be sure the lawnmower is in safe working condition.
2. Replace worn or damaged parts for safety.
3. Check the grass catcher frequently for wear or deterioration.
3. Only use the replacement blade, blade bolt, spacer and impeller specified for this product.
4. Never store the lawnmower with fuel in the tank inside a building where fumes can reach an open flame or spark.
5. Allow the engine to cool before storing in any enclosure.
6. To reduce fire hazard, keep the engine, silencer, battery compartment and fuel storage area free of grass, leaves or excessive grease.
7. If the fuel tank has to be drained, this should be done outdoors.
8. Be careful during adjustment of the machine to prevent entrapment of the fingers between moving blades and fixed parts of the machine.

Assembly Instructions

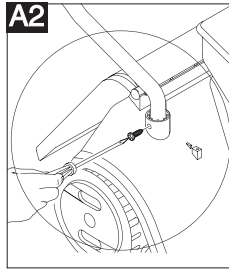
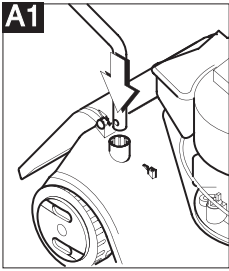

Lower Handles

1. Insert the lower handle into the deck as shown in **Fig. A1**
2. Push the handle firmly down until it is located securely into the deck.
3. Insert the screw into the hole using a pozidrive screwdriver and tighten fully. (**A2**). Repeat for other side

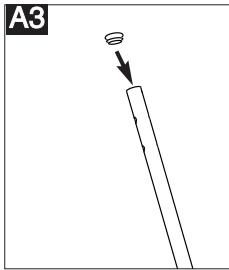

Lower Handle Plug

1. Insert the two lower handle plugs into the top of each of the lower handles (**A3**).

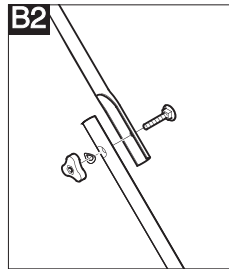

Upper Handles

When viewing product from the rear the yellow Warning labels should be facing upwards.

1. Insert the nut into the handle knob (**B1**)
2. Align the holes in the upper and lower handles and secure with the bolt, washer and handle knob (**B2**).
3. Fit the cables to the handles with the cable ties provided, making sure the cables are not trapped between the upper and lower handles.

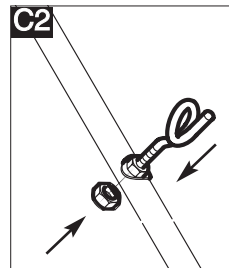
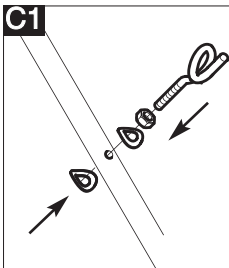

Cord Guide

1. Attach the cord guide, nut and washers as illustrated in **Fig. C1** using a 10mm spanner.
2. Using a spanner, attach the locknut to the cord guide until it is secure, (**C2**) ensuring the cord guide is in the correct position (**C3**).

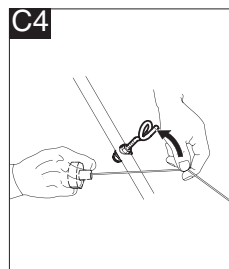
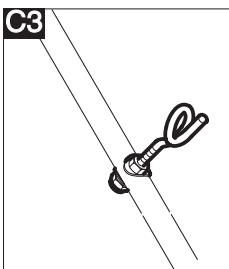

3. Disconnect the spark plug lead.
4. Pull the brake lever fully towards the handle (on left hand side of handle when viewed from the rear).
5. Extend the pull cord fully.
6. Locate the cord in the cord guide positioned on the handle (**C4**).

Assembly Instructions cont'

D1

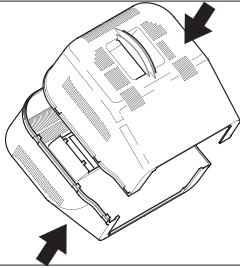

D2

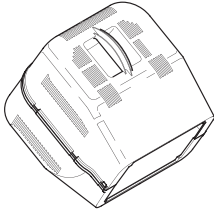

Grassbox Assembly

1. Position the two grassbox halves together (**D1**) and press each location point into position **without** fully connecting the clips.
2. When the location points are matched correctly firmly press the grassbox together until all clips are securely connected. (**D2**)

Cutting Height Adjustment

E1

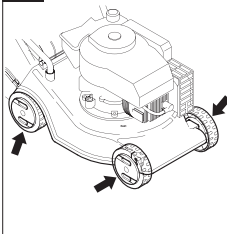

E2

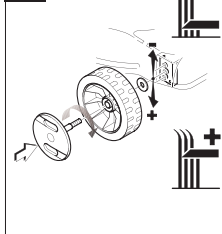

Cutting Height

The cutting height can be adjusted by removing the front and back wheels on the product.

1. Remove the wheel by turning the wheel hub in an anti-clockwise direction (**E1**) and relocate in new hole turning the wheel hub in a clockwise direction to tighten (**E2**). Repeat for other wheels adjusting to the same position.

POWERDRIVE VERSION

1. When the rear wheels are removed the height adjustment holes can be viewed by moving the drive wheel disc up and down,

Engine Notes

Oil

1. To fill with oil:-
 - a) Remove oil filter cap.
 - b) Fill to the FULL mark on the dipstick.
2. Use a good quality SAE 30 four stroke oil.
3. Check oil level periodically and after every five hours of operation.
4. Add oil as necessary to keep the level to the FULL mark on the dipstick.
5. Change the oil after the first **five hours** operation and thereafter every 25 working hours.
6. Always change the oil while the engine is warm - but not hot - never attempt any maintenance on a hot engine.
Refer to the Engine Operators Manual for further information.

Petrol

1. Use fresh regular grade lead free petrol.
2. **NEVER USE LEADED PETROL**
Using leaded petrol will make the exhaust smoke and cause irreparable damage to engines fitted with a catalytic converter.
3. Do not fill the fuel tank when the engine is hot.
4. Do not fill the fuel tank while smoking.
5. Do not fill the fuel tank while the engine is running.
6. To avoid introducing dirt into the fuel system, wipe all grass and dirt from the petrol filler cap before unscrewing it.
7. It is recommended that you fill the tank through a funnel with a filter.
8. Wipe away spillages before starting.

Starting and Stopping

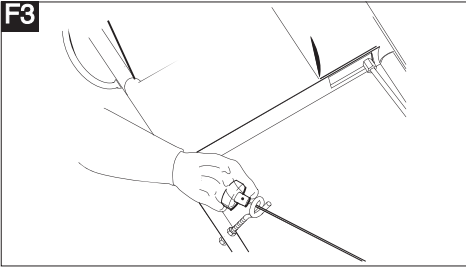
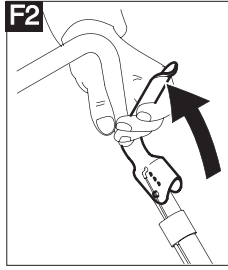
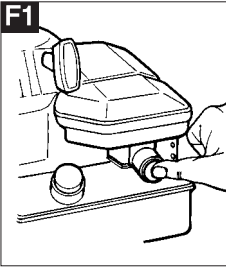

Please note:- When starting the engine for the first time, fill with oil and petrol as described above in the Engine Notes section.

PUSH LAWNMOWER

1. Connect the spark plug lead.

Starting the cold engine

Push primer bulb firmly **3 times** before starting cold engine.

- (F1)** (Also, if the engine has stopped because it has run out of fuel, refuel engine and push primer 3 times).

Starting the warm engine

NOTE: Priming is usually unnecessary when restarting a warm engine. However, cool weather (55°F/13°C or below) may require priming to be repeated.

2. Pull the brake lever fully towards the handle **(F2)** (on left hand side of handle when viewed from the rear).

3. Pull the recoil starter **(F3)** cord towards you until you feel the full resistance, return the handle slowly then pull the handle firmly towards you to its full extent.

4. After the engine has started, allow to run for 30 seconds before commencing to use.

To stop your lawnmower - release the start/stop lever
POWERDRIVE LAWNMOWER

1. Follow the procedure for **Push** lawnmowers.
2. Forward drive is engaged and disengaged with the Powerdrive lever (on right hand side of handle when viewed from the rear).
3. Releasing the Powerdrive Lever stops the forward drive automatically.

To stop your lawnmower - release the Powerdrive lever, then the start/stop lever.

Maintenance

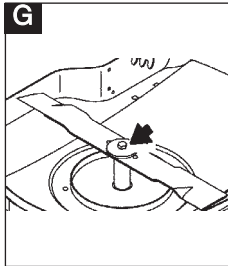

Always remove the spark plug lead before repair, cleaning or maintenance work.

All nuts, bolts and screws should be checked for tightness after 5 hours use.

Check the oil.

Push the handle down to ground level when tilting the mower for cleaning purposes. This will avoid oil spillage.

Regularly

1. Hose down or brush off all grass, leaves, etc., from the mower.
2. Check the oil level.

Always handle the blade with care - sharp edges could cause injury.

USE GLOVES

Renew your metal blade after 50 hours mowing or 2 years whichever is the sooner - regardless of condition. **If the blade is cracked or damaged replace it with a new one.**

ANNUALLY CARRY OUT THE FOLLOWING:

1. Sharpening and balancing the cutter blade.
 - Remove the spark plug lead. Remove the cutter blade and take it to a service workshop for sharpening and balancing. When reassembling the blade ensure that the retaining washer is flat and not dished, tighten the bolt to a torque of 35-40 Nm. **(G)**
2. Change the oil after each season or after 25 hours. Run the engine until warm. **Remove the spark plug lead.** Remove the blade to gain access to the oil drain plug, using a 3/8" sq. drain plug key. Refer to the Engine Owners Manual. Open the drain plug underneath the mower and let the oil run out. Refit the plug and fill with new oil.
3. Remove cover and take out the air filter. **(H1 & H2)**
4. Clean the filter with warm, soapy water and dry thoroughly. Add 2-3 spoons of oil, distributing evenly throughout the filter.

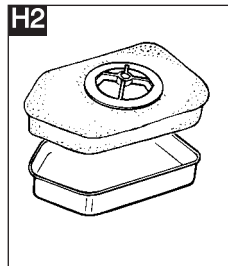
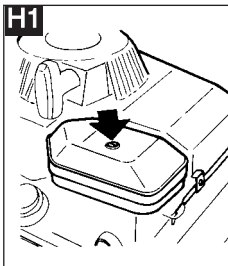

Maintenance cont'

Transport

Remove the spark plug lead

Loosen the wire/cable from the handle before carefully folding it. Avoid damaging the wire/cable.
Empty the petrol tank. The machine must be drained of oil and fuel when moving it by public transport.

Service

When ordering spare parts, always quote the mower's product number. Always check oil level after service.

At the End of the Mowing Season

1. Replace blade, bolts, nuts or screws, if necessary.
2. Clean your lawnmower thoroughly.
3. Ask your local Service Centre to clean the air filter thoroughly and carry out any service or repairs required.
4. Drain engine of oil.

Storing your Lawnmower

1. Do not store your lawnmower immediately after use.
2. Wait until the engine has cooled to avoid a potential fire hazard.
3. Clean your lawnmower
4. Store in a cool, dry place where your lawnmower is protected from damage.

Service Recommendations

Your product is uniquely identified by a silver and black product rating label.

We strongly recommend that your product is serviced at least every twelve months, more often in a professional application.

Engine Maintenance Schedule

Follow the hourly or calendar intervals, whichever occur first. More frequent service is required when operating in adverse conditions.

First 5 hours - Change oil.

Every 5 hours or daily - Check oil level.

Clean finger guard. Clean around muffler.

Every 25 hours or every season - Change oil if operating under heavy load or high ambient temperature. Service air cleaner.

Every 50 hours or every season - Change oil. Inspect spark arrester, if equipped.

Every 100 hours or every season - Clean cooling system*. Replace spark plug.

* Clean more often under dusty conditions, or when airborne debris is present or after prolonged operation cutting tall, dry grass.

Engine Servicing & Guarantee

The engine fitted to your lawnmower is guaranteed by the Engine Manufacturer.

Fault Finding

Fault Finding

Engine Will Not Start

1. Check that there is sufficient fuel in the tank and the cap air vent is clear.
 2. Remove and dry the spark plug.
 3. Petrol may be stale. Replace. Once petrol has been replaced, it may take a little time for fresh petrol to filter through.
 4. Check that the blade bolt is tight. A loose bolt could cause difficult starting.
 5. **If the engine will still not start, immediately disconnect the spark plug lead.**
 6. **CONSULT YOUR LOCAL APPROVED SERVICE CENTRE.**
- #### Lack of Engine Power and/or Overheating

1. Disconnect the spark plug lead and allow the engine to cool down.
2. Clean grass clippings and debris from around the engine and air inlets and the underside of the deck.

3. Clean the engine air filter (Ask your local Approved Service Centre to clean the engine air filter thoroughly).
4. Petrol may be stale. Replace. Once petrol has been replaced, it may take a little time for fresh petrol to filter through.
5. **If the engine still lacks power and/or is overheating, immediately disconnect the spark plug lead.**

6. **CONSULT YOUR LOCAL APPROVED SERVICE CENTRE.**

Excessive Vibration

1. Disconnect the spark plug lead.
2. Check that the blade is correctly fitted.
3. If the blade is damaged or worn replace it with a new one.
4. If vibration persists, turn the blade through 180° by first loosening the blade bolt, turning the blade and re-tightening the blade bolt.
5. **If vibration persists, immediately disconnect the spark plug lead.**
6. **CONSULT YOUR LOCAL APPROVED SERVICE CENTRE.**

Guarantee & Guarantee Policy

If any part is found to be defective due to faulty manufacture within the guarantee period, Husqvarna UK Ltd., through its Authorised Service Repairers will effect the repair or replacement to the customer free of charge providing:

- (a) The fault is reported directly to the Authorised Repairer.
- (b) Proof of purchase is provided.
- (c) The fault is not caused by misuse, neglect or faulty adjustment by the user.
- (d) The failure has not occurred through fair wear and tear.
- (e) The machine has not been serviced or repaired, taken apart or tampered with by any person not authorised by Husqvarna UK Ltd.
- (f) The machine has not been used for hire.
- (g) The machine is owned by the original purchaser.
- (h) The machine has not been used commercially.

* This guarantee is additional to, and in no way diminishes the customers statutory rights. Failures due to the following are not covered, therefore it is important that you read the instructions contained in this Operator's Manual and understand how to operate and maintain your machine:

Failures not covered by guarantee

- * Replacing worn or damaged blades.
- * Failures as a result of not reporting an initial fault.
- * Failures as a result of sudden impact.
- * Failures as a result of not using the product in accordance with the instructions and recommendations contained in this Operator's Manual.
- * Machines used for hire are not covered by this guarantee.
- * The following items listed are considered as wearing parts and their life is dependent on regular maintenance and are, therefore not normally subject to a valid warranty claim: Blade, Electric Mains cable, belt.
- * **Caution!** Husqvarna UK Ltd. does not accept liability under the warranty for defects caused in whole or part, directly or indirectly by the fitting of replacement parts or additional parts that are not either manufactured or approved by Husqvarna UK Ltd., or by the machine having been modified in any way.

Service Recommendations

1. We strongly recommend that your product is serviced at least every twelve months, more often in a professional application.
2. Always use genuine Husqvarna Spare Parts.
3. Prepacked spares are available from most Husqvarna UK Ltd. stockists.
4. Your product is uniquely identified by a silver and black product rating label
5. If you have a problem with your machine contact your local Approved Service Centre ensuring you have full details of your product as described on the product rating label.
6. **Should it be necessary for work to be carried out by**

your Service Centre, it is important to take your complete machine.

A network of specialist dealers can be found in your local Yellow Pages.

To obtain service on your Husqvarna product simply telephone or visit your local Service Centre.

Should you require service under the terms of our guarantee the Service Centre will require proof of purchase.

All of the centres listed stock genuine Husqvarna Spare Parts.

NOTE: Our Service Repairers act on their own behalf and are not empowered to commit or legally bind Husqvarna UK Ltd. in any manner whatsoever.

Environmental Information

ENVIRONMENTAL INFORMATION

Husqvarna UK Ltd. are manufactured under an Environmental Management System (ISO 14001) using, where practical, components manufactured in the most environmentally responsible manner, according to company procedures, and with the potential for recycling at the end of the products' life.

- Packaging is recyclable and plastic components have been labelled (where practical) for categorised recycling.
- Awareness of the environment must be considered when disposing of 'end-of-life' product.
- If necessary, contact your local authority for disposal information.

DISPOSAL OF FUELS AND LUBRICATING OILS

- Wear protective clothing when handling any fuels and lubricants.
- Avoid contact with skin.
- Remove petrol and engine oil before transporting the product.
- Contact your local authority for information of your nearest Recycling/Disposal Station.



Do NOT dispose of used fuels/oils with household waste



Waste fuels/oils are harmful, but can be recycled and should be disposed of through the recognised facilities.



Do NOT dispose of used fuels/oils to water.



Do NOT incinerate

EC Declaration of Conformity

Husqvarna UK Ltd., Aycliffe Industrial Park
Newton Aycliffe, Co. Durham, DL5 6UP, England

Declare under our sole responsibility that the product(s);

Category.....**Petrol Lawnmower**
Type(s)**540, 540D**
Identification of Series.....**See Product Rating Label**
Year of Construction.....**See Product Rating Label**

Conforms to the essential requirements & provisions of the following EC Directives:
98/37/EC (until 31.12.09), 2006/42/EC (from 01.01.10), 2004/108/EC, 2000/14/EC
based on the following EU harmonized standards applied:

EN 836, EN ISO 14982, EN ISO 20643, EN ISO 3744, EN ISO 11201

The maximum A weighted sound pressure level L_{pA} at the operator's position, recorded on a sample of the above product(s) corresponds to the **Level** given in the table.

The maximum hand / arm vibration weighted value measured according to EN ISO 5349 on a sample of the above product(s) corresponds to the **Value** given in the table.

2000/14/EC: The Measured Sound Power L_{WA} & Guaranteed Sound Power L_{WA} values are according to the tabulated figures.

Conformity Assessment Procedure..... Annex VI
Notified Body..... Intertek, Cleeve Road
Leatherhead, Surrey
KT22 7SB, England

Newton Aycliffe 12/12/2008
M.Bowden
Research & Development Director
Husqvarna UK Ltd.



Type	540	540D
Width of Cut (cm)	40	40
Speed of Rotation of Cutting Device (rpm)	3000	3000
Measured Sound Power L_{WA} (dB(A))	95	95
Guaranteed Sound Power L_{WA} (dB(A))	96	96
Level (dB(A))	81	81
Value (m/s ²)	5	5
Weight (Kg)	21	23

Husqvarna UK LTD.
Aycliffe Industrial Park
NEWTON AYCLIFFE
Co.Durham DL5 6UP
ENGLAND

Telephone - 01325 302302 Fax - 01325 310339

Our policy of continuous improvement means that the specification of products may be altered from time to time without prior notice.

