

- GB** **INSTRUCTION MANUAL**  
**IMPORTANT INFORMATION:** Please read these instructions carefully and make sure you understand them before using this unit. Retain these instructions for future reference.
- DE** **BETRIEBSANWEISUNG**  
**WICHTIGE INFORMATION:** Lesen Sie diese Hinweise zur Handhabung des Geräts aufmerksam durch. Verwenden Sie es erst, wenn Sie sicher sind, daß Sie alle Anweisungen verstanden haben und gut aufbewahren.
- FR** **MANUEL D'INSTRUCTIONS**  
**RENSEIGNEMENTS IMPORTANTS:** Avant d'utiliser cet appareil, veuillez lire attentivement les instructions et assurez-vous de les avoir comprises. Conservez les instructions pour référence ultérieure.
- NL** **HANDLEIDING**  
**BELANGRIJKE IMPORTANTS:** Lees deze handleiding aandachtig en zorg dat u alles begrijpt alvorens de kettingzaag te gebruiken en bewaar ze voor toekomstige raadpleging.
- NO** **BRUKERHÅNDBOK**  
**VIKTIG INFORMASJON:** Les disse anvisningene nøye og forsikre deg om at du forstår dem før du bruker enheten og oppbevar dem for senere bruk.
- FI** **OHJEKIRJA**  
**TÄRKEÄÄ TIETOA:** Lue nämä ohjeet huolellisesti ja varmista, että olet ymmärtänyt ne, ennen kuin alat käyttää tätä laitetta ja säilytä myöhempää tarvetta varten.
- SE** **BRUKSANVISNING**  
**VIKTIG INFORMATION:** Läs instruktionerna noggrant och försäkra dig om att du förstår dem innan du använder utrustningen och sp för framtida behov.
- DK** **BRUGERHÅNDBOG**  
**VIGTIGE OPLYSNINGER:** Læs instruktionerne omhyggeligt, før du bruger enheden og gemme til senere henvisning.
- ES** **MANUAL DE INSTRUCCIONES**  
**INFORMACIÓN IMPORTANTE:** Lea atentamente las instrucciones y asegúrese de entenderlas antes de utilizar esta aparato. Conserve las instrucciones para la referencia en el futuro.
- PT** **MANUAL DO OPERADOR**  
**INFORMAÇÕES IMPORTANTES:** Queira ler cuidadosamente estas instruções e tenha certeza de entendê-las antes de usar a serra e guarde para consulta futura.
- IT** **LIBRETTO D'ISTRUZIONI**  
**INFORMAZIONI IMPORTANTI:** Leggere le istruzioni attentamente e capirle bene prima di usare la motosega. Conservare per ulteriore consultazione.
- GR** **ΕΓΧΕΙΡΙΔΙΟ ΧΕΙΡΙΣΜΟΥ**  
**ΣΗΜΑΝΤΙΚΕΣ ΠΑΡΟΡΟΦΟΡΙΕΣ:** Διαβάστε προσεκτικά αυτές τις οδηγίες και φροντίστε να τις κατανοήσετε πριν χρησιμοποιήσετε αυτό το μηχανήμα και φυλάξτε το για να το συμβουλευτείτε στο μέλλον.
- HU** **HASZNÁLATI UTMUTATÓ**  
**Jótanálat** vállalni csak rendeltetés szerűen használatba vett gépekre tudunk. Kérj ü hogy a gép használatba vétele előtt gondosan olvassa el a kezelési utasításokat.
- SK** **NÁVOD NA OBSLUHU** Dôležitá informácia: Pred použitím stroja si starostlivo prečítajte tento návod na obsluhu a uistite sa že ste mu dôkladne porozumeli. Návod starostlivo uschovajte pre potrebu v budúcnosti.
- CZ** **NÁVOD K POUŽÍVÁNÍ** DŮLEŽITÁ INFORMACE!  
 Než začnete stroj používat přečtěte si prosím velmi pozorně tyto instrukce a ujistěte se, že jste jim porozuměli. Uchovejte si tento návod pro použití i v budoucnu.
- EE** **KASUTUSJUHEND**  
**TÄHTIS INFORMATSIOON:** Palun lugege hoolikalt läbi kasutusjuhised ja veenduge, et mõistate neid enne kui hakkate andud seadet kasutama. Hoidke kasutusjuhend alles juhaks kui kunagi hiljem peaks tekkima küsimusi.
- LV** **VARTOJIMO INSTRUKCIJA**  
**SVARBI INFORMACIJA:** Prašome atidžiai perskaityti instrukciją ir kruopščiai susipažinti su šio gaminio naudojimu. Saugokite instr. kliją, jos gali prireikti ateityje iškilus klausimams.
- PL** **INSTRUKCJA OBSUUGI** Gwarancja traci waynoúa w przypadku uýywania urzãdzenia do celów innych niý wymienione w instrukcji obsuugi. Prosimy o uwagñe przeczytanie instrukcji oraz o stowanie siã do zaleceñ i wskazówek w niej zawartych.
- TR** **KULLANMA KYLAVUZU**  
**ÖNEMLİ TALİMATLAR:** Buradaki bilgileri dikkatlice okuyunuz ve alet kullanmaya başlamadan önce tüm talimatların tarafınızdan anlaşılması için okuyun. Gerektiği zaman başvurabileceğiniz için saklayınız.
- RU** **ИНСТРУКЦИЯ ПО ЭКСПЛУАТАЦИИ**  
**ВАЖНАЯ ИНФОРМАЦИЯ:** Перед тем как приступить к работе внимательно прочитайте данную инструкцию и убедитесь что вы ее поняли. Сохраните инструкцию для дальнейшего обращения к ней.

Husqvarna Outdoor Products Italia S.p.A.  
 Via Como 72 - 23868 Valmadrera (LC) - ITALY  
 Tel. + 39 0341 203111 - Fax +39 0341 581671

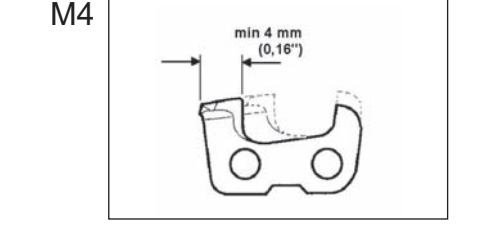

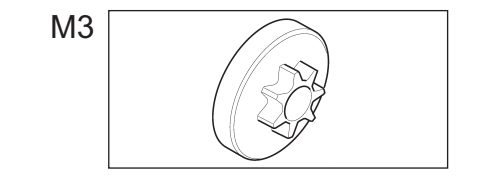

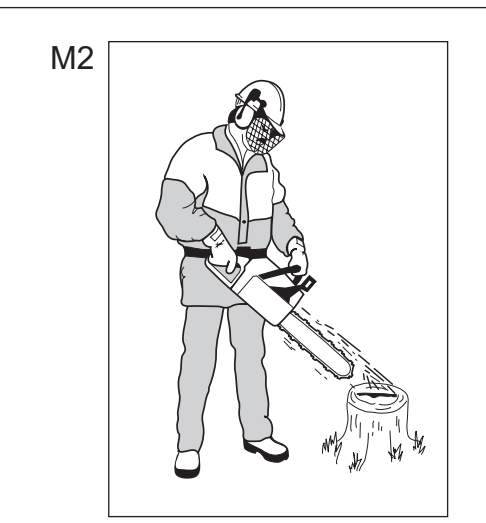
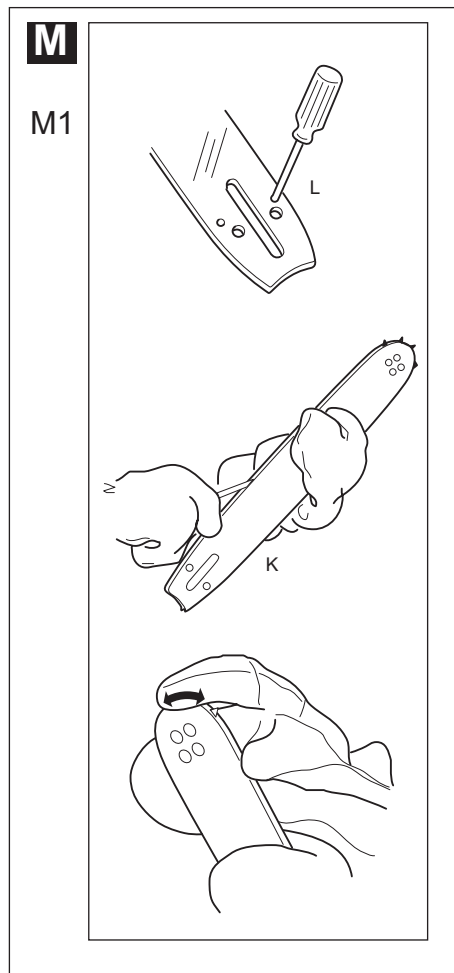
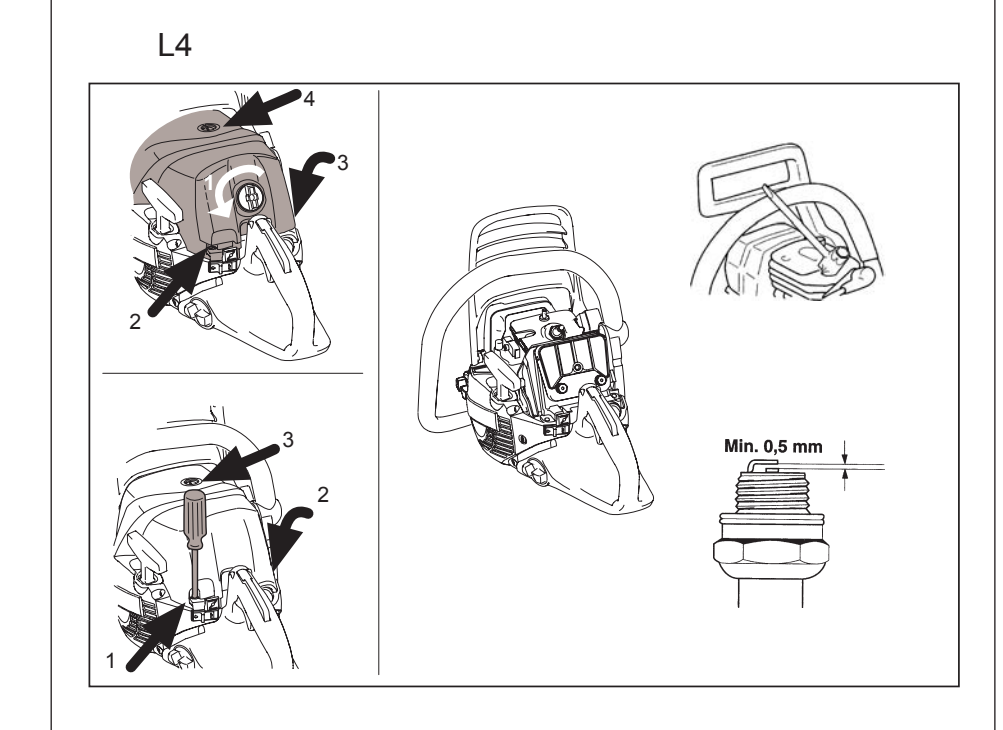
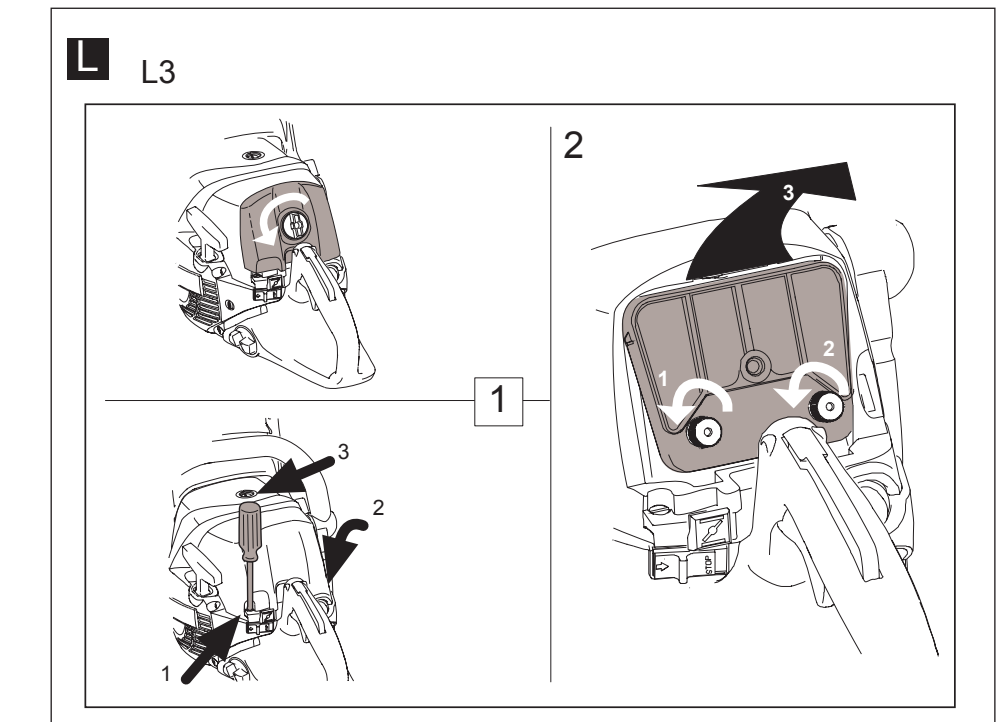
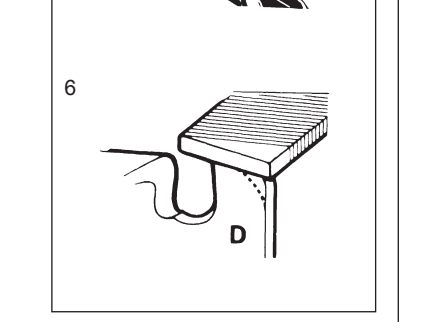
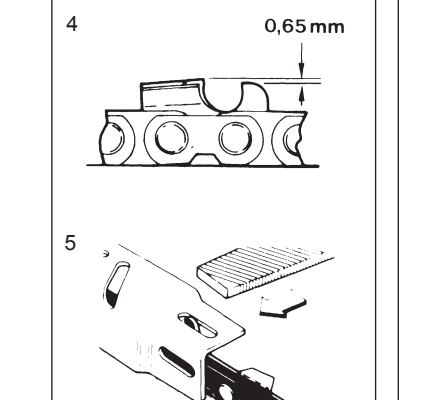
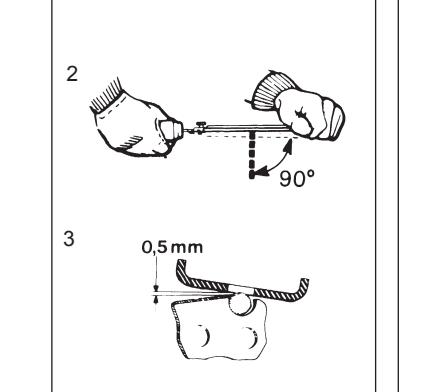
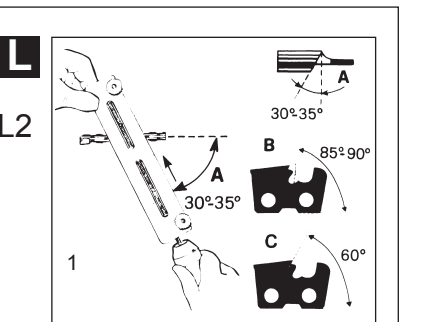
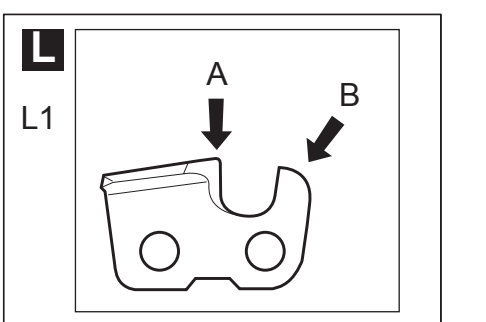
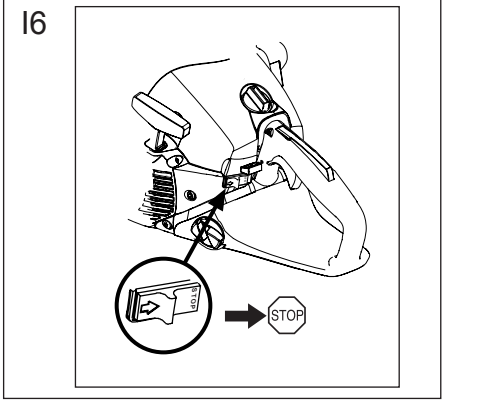
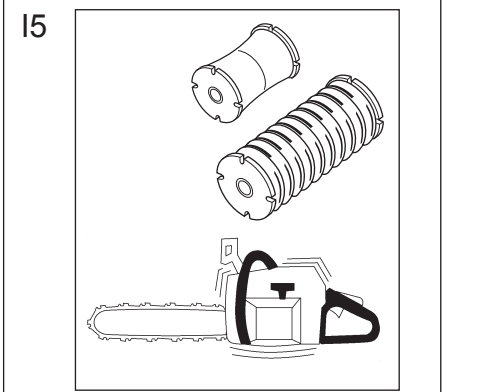
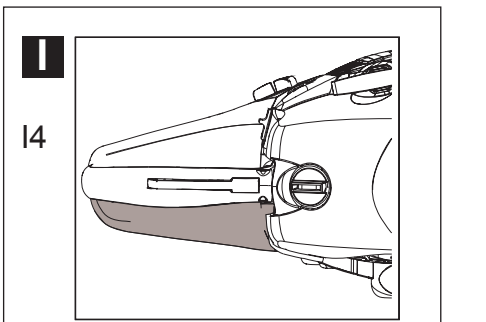
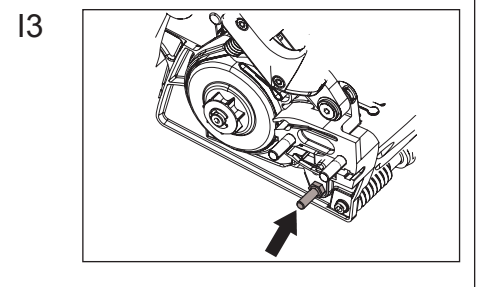
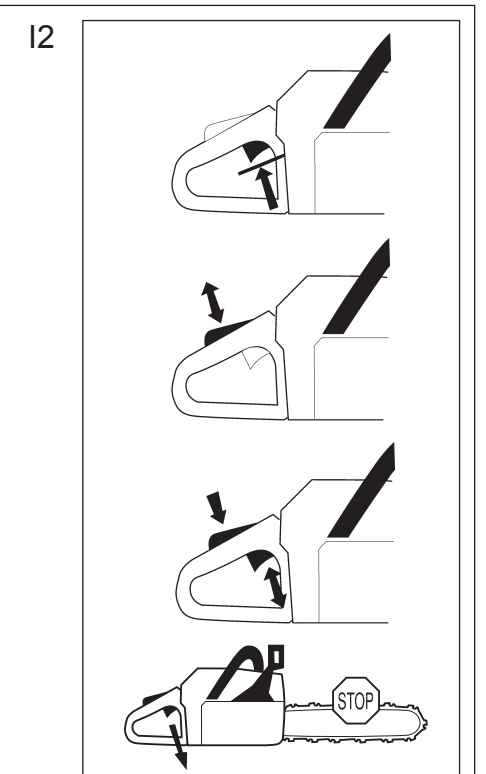
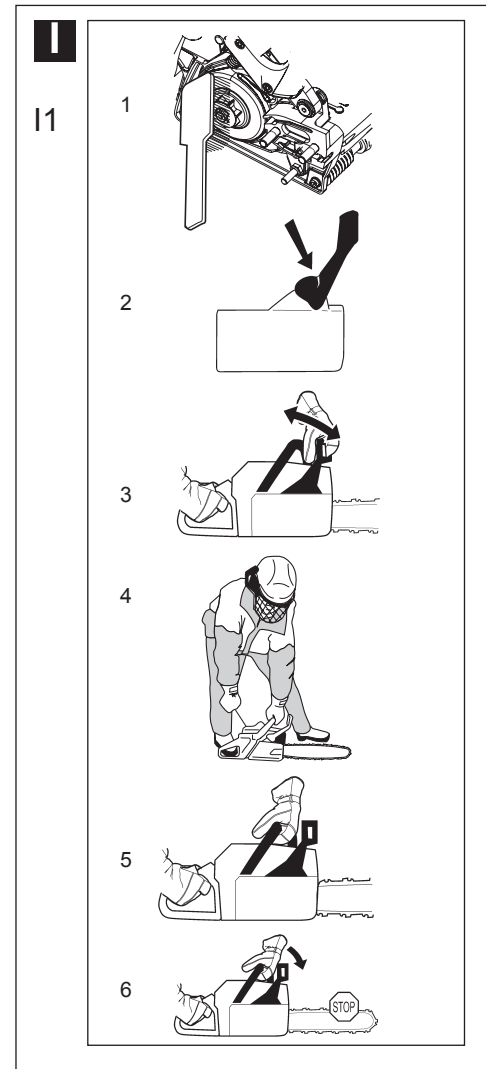
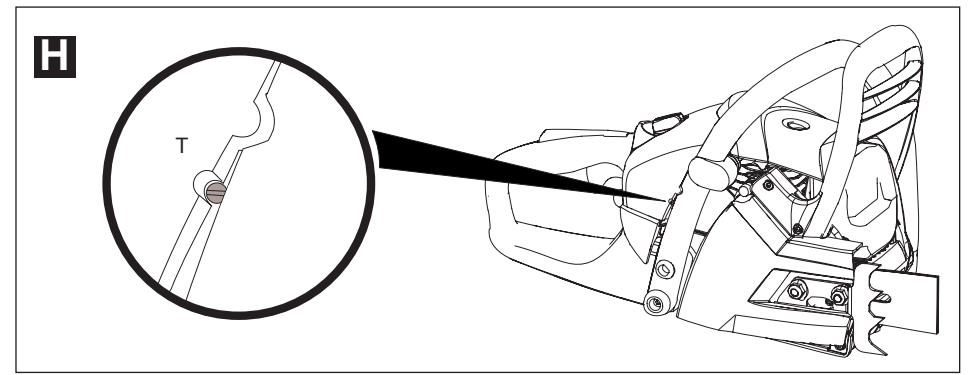
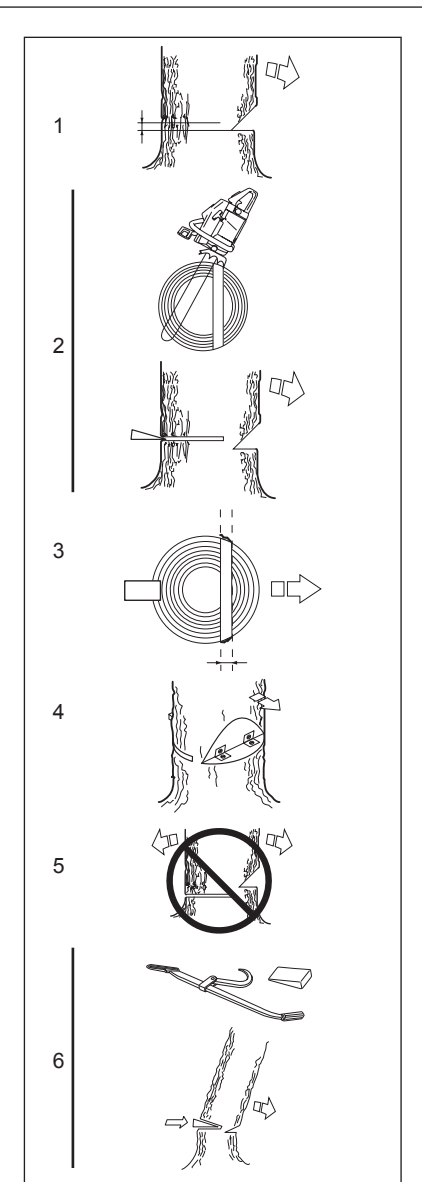
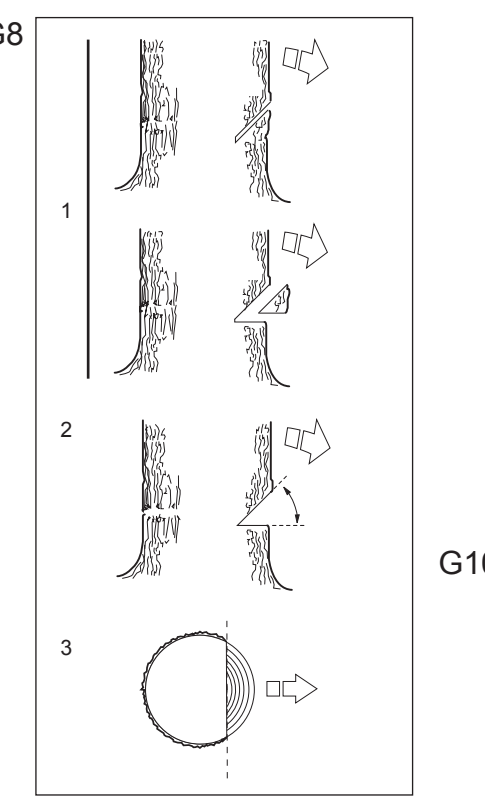
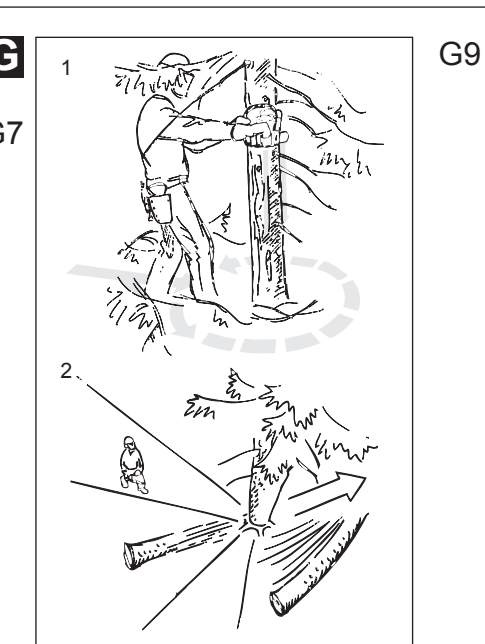
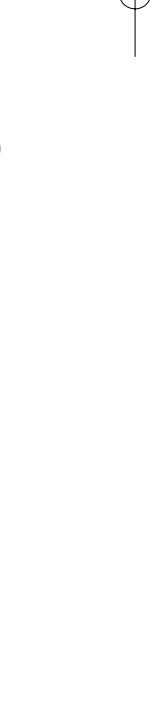
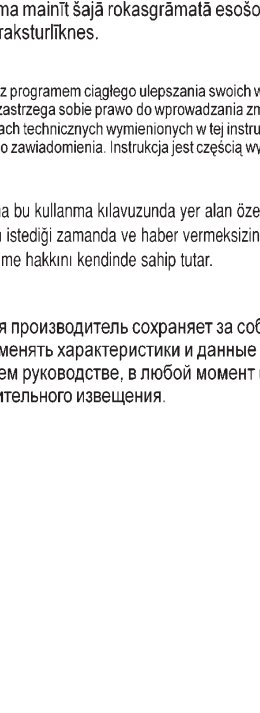
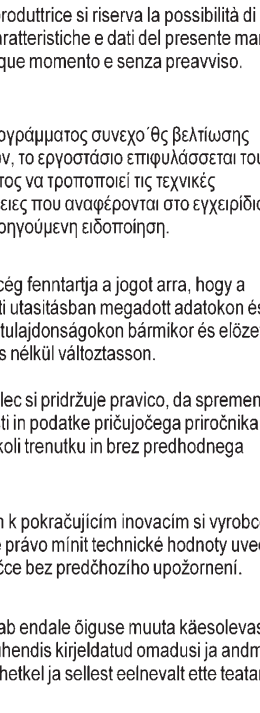
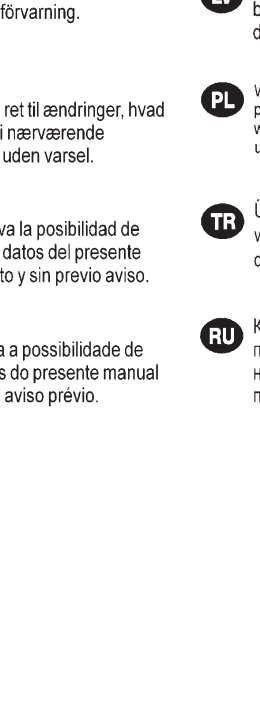
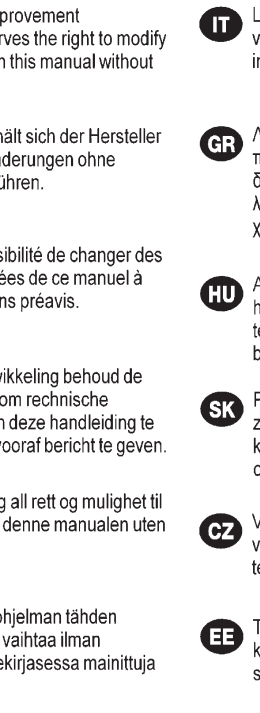
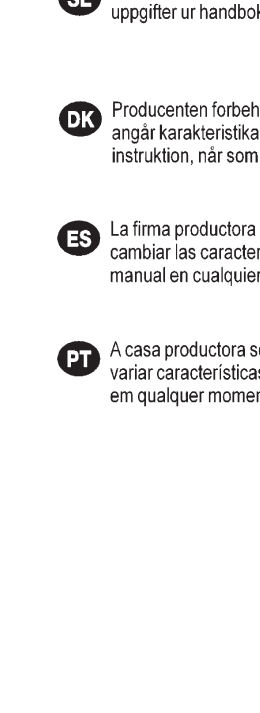
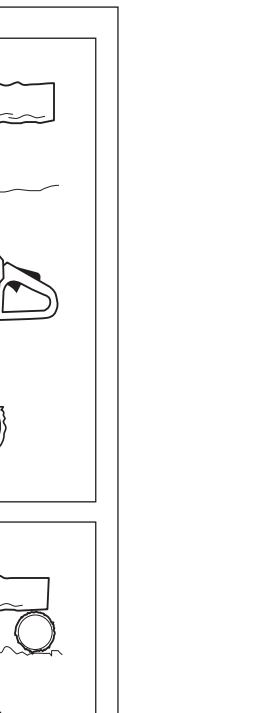
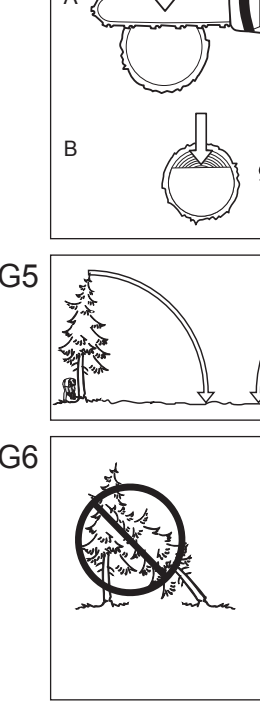
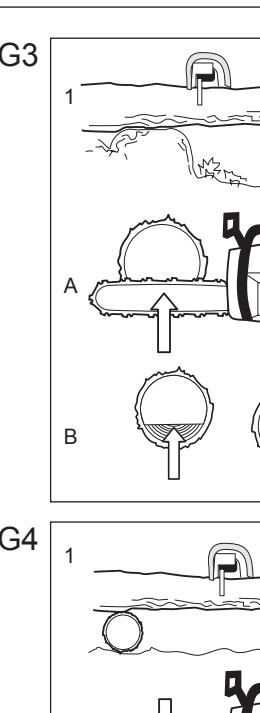
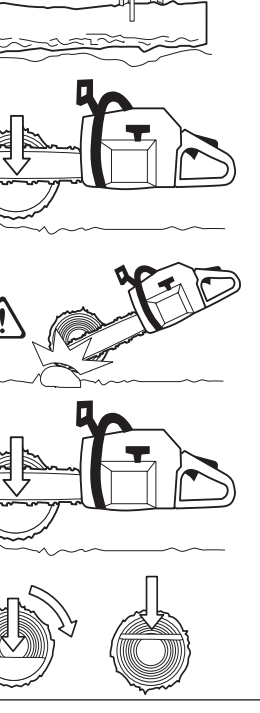
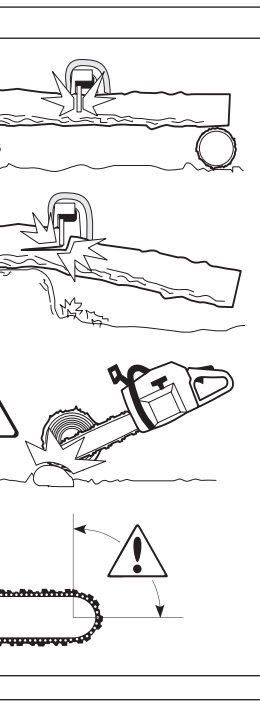
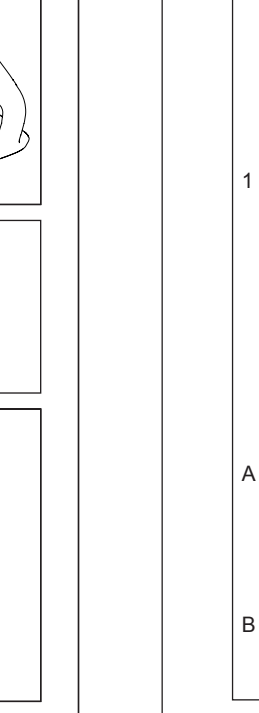
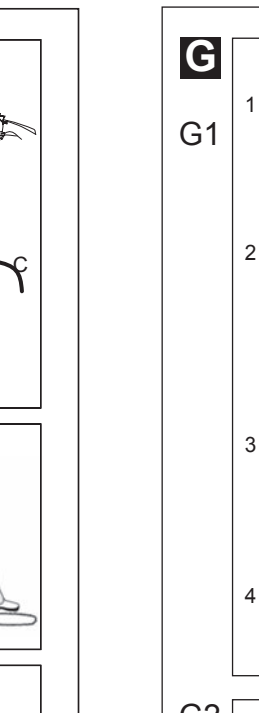
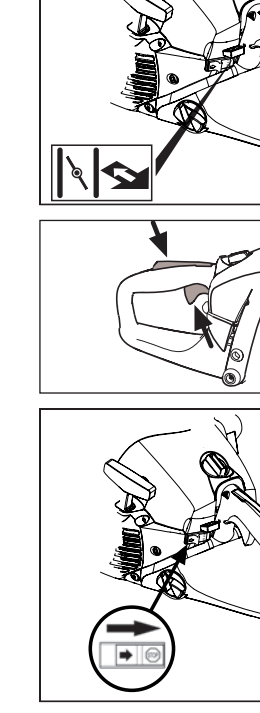
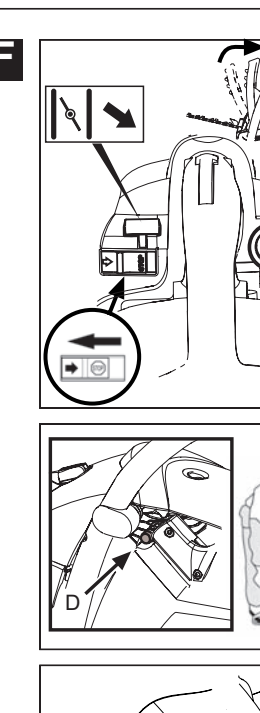
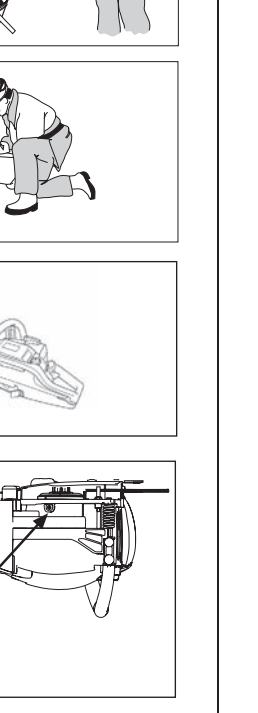
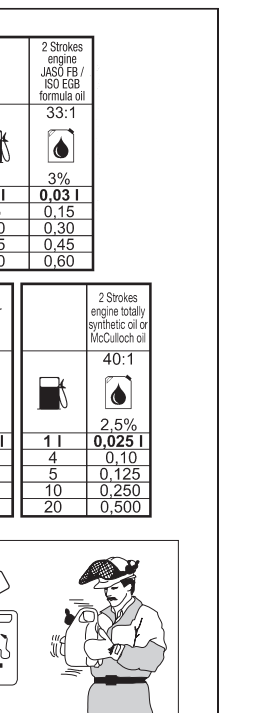
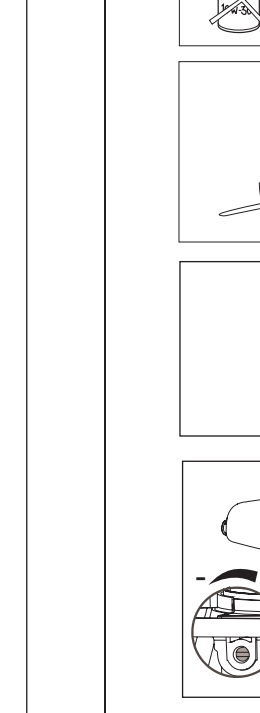
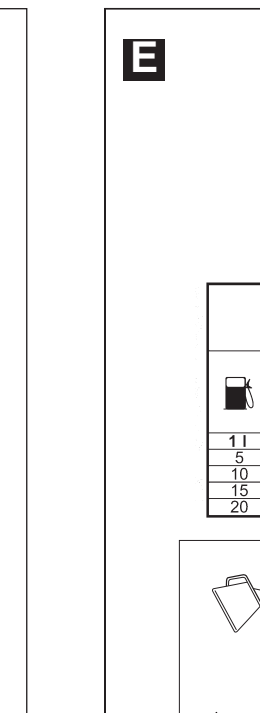
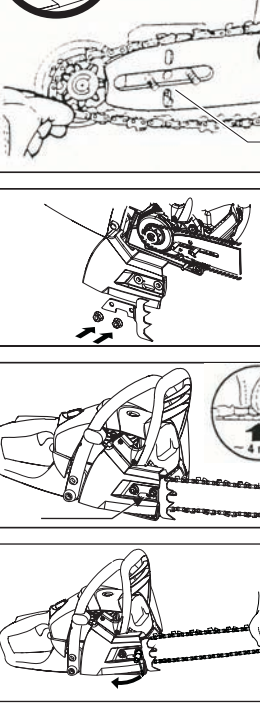
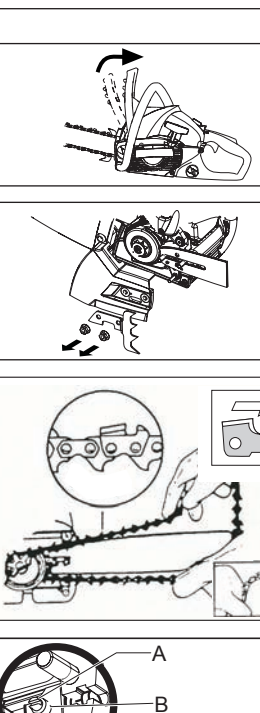
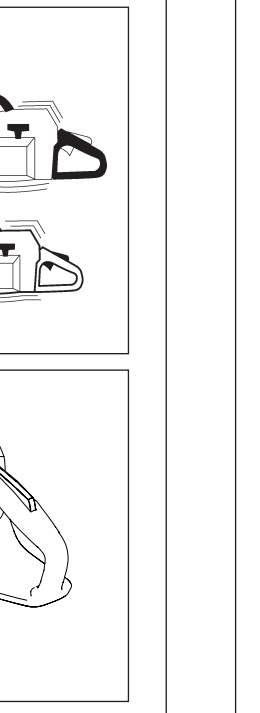
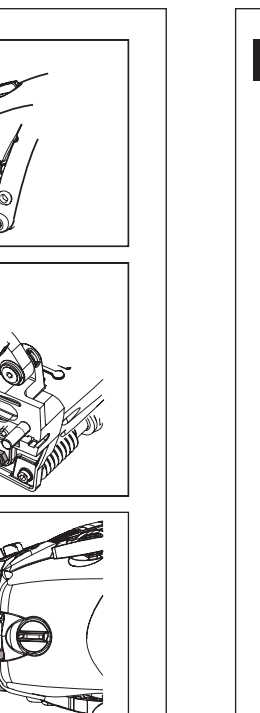
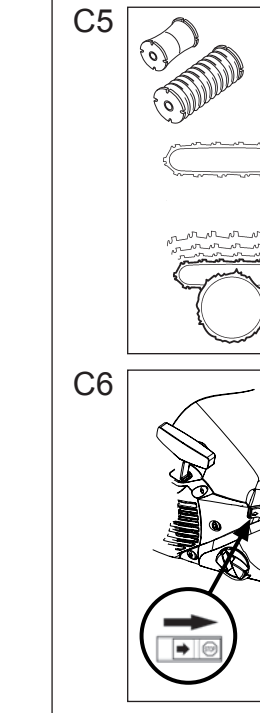
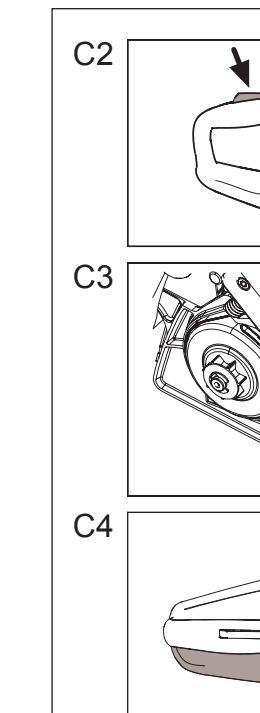
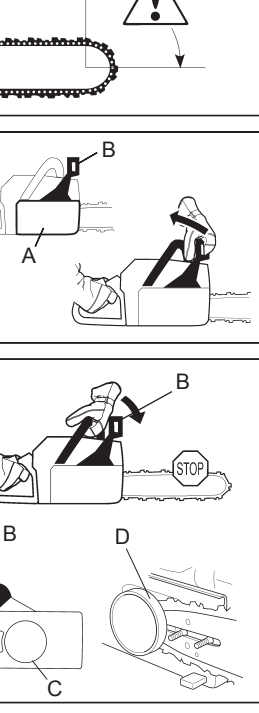
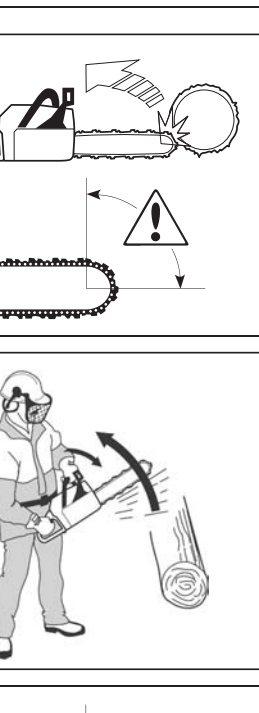
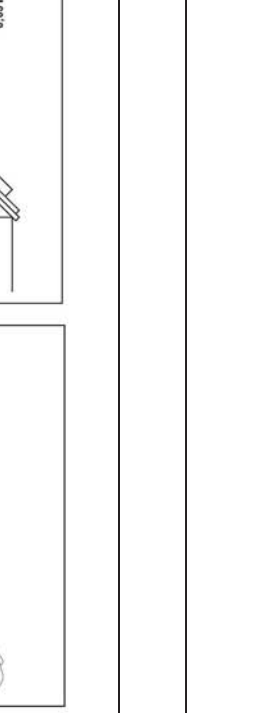
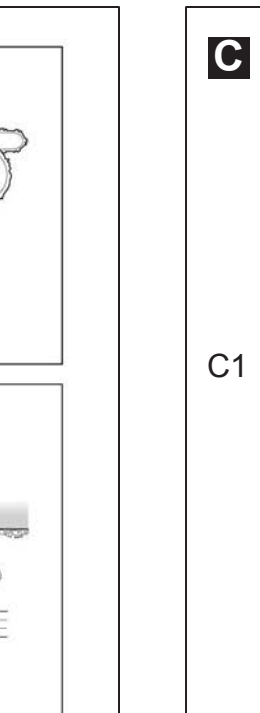
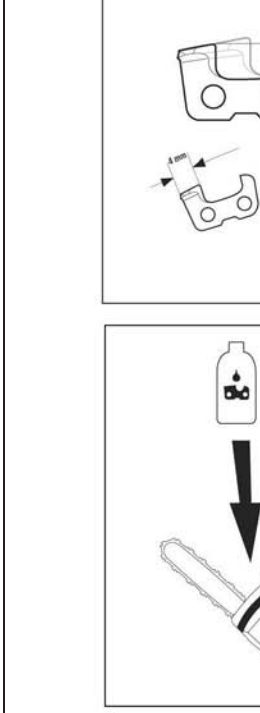
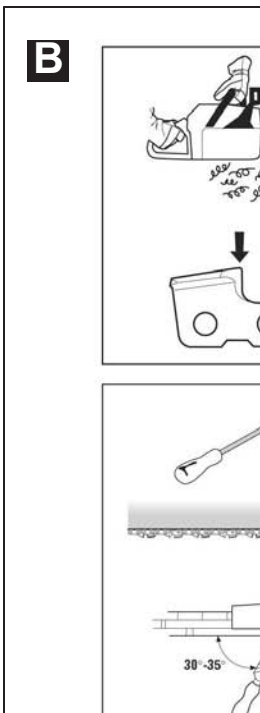
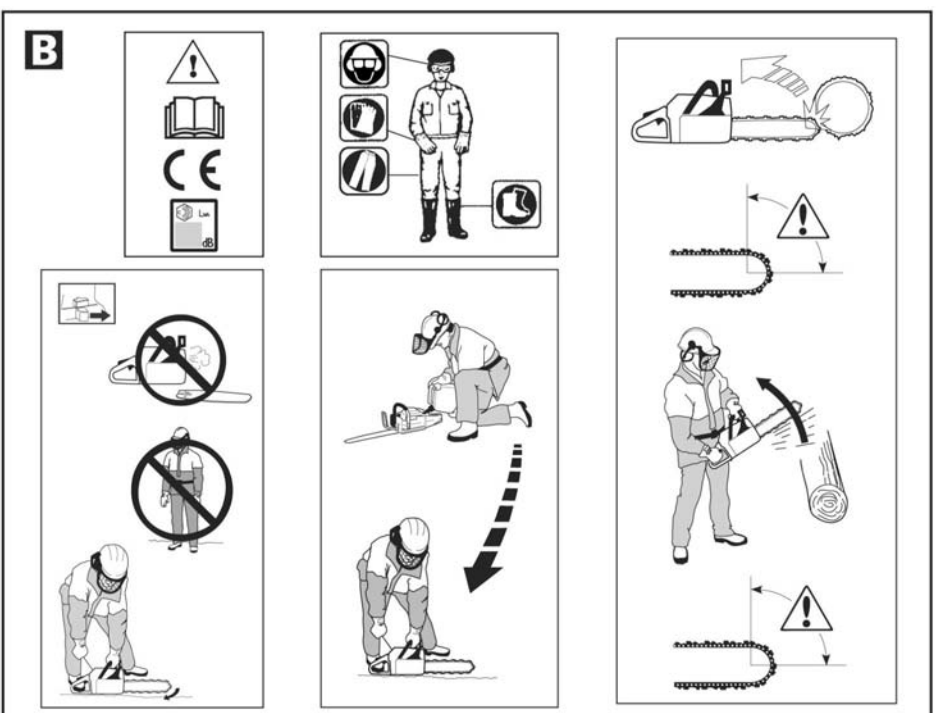
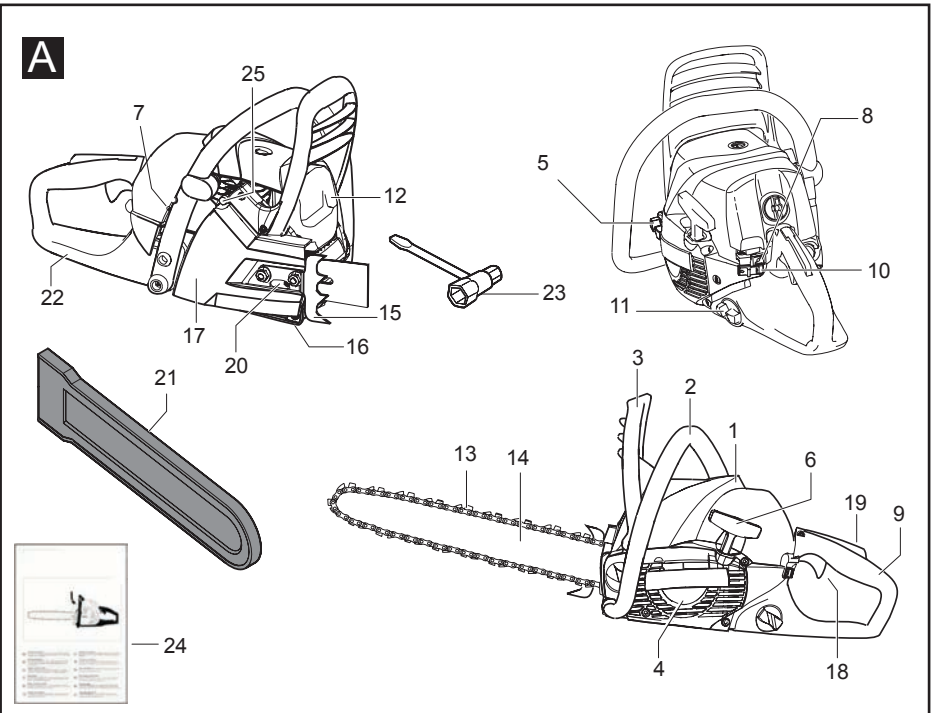

## A. General description

- |   |  |
|---|--|
| <ol style="list-style-type: none"> <li>1. CYLINDER LID</li> <li>2. FRONT HANDLE</li> <li>3. FRONT HAND GUARD</li> <li>4. RECOIL STARTER</li> <li>5. CHAIN OIL TANK</li> <li>6. STARTER HANDLE</li> <li>7. REGULATION SCREWS, CARBURETTOR</li> <li>8. ENRICHER/CHOKE</li> <li>9. REAR HANDLE</li> <li>10. STOP SWITCH</li> <li>11. FUEL TANK</li> <li>12. SILENCER</li> <li>13. CHAIN</li> </ol> | <ol style="list-style-type: none"> <li>14. GUIDE BAR</li> <li>15. SPIKED BUMPER</li> <li>16. CHAIN CATCHER</li> <li>17. CLUTCH COVER</li> <li>18. TRIGGER</li> <li>19. THROTTLE TRIGGER LOCKOUT</li> <li>20. CHAIN TENSIONER SCREW</li> <li>21. GUIDE BAR COVER</li> <li>22. RIGHT HAND REAR PROTECTION</li> <li>23. KEY</li> <li>24. INSTRUCTION MANUAL</li> <li>25. DECOMPRESSION VALVE</li> </ol> |
|---|--|

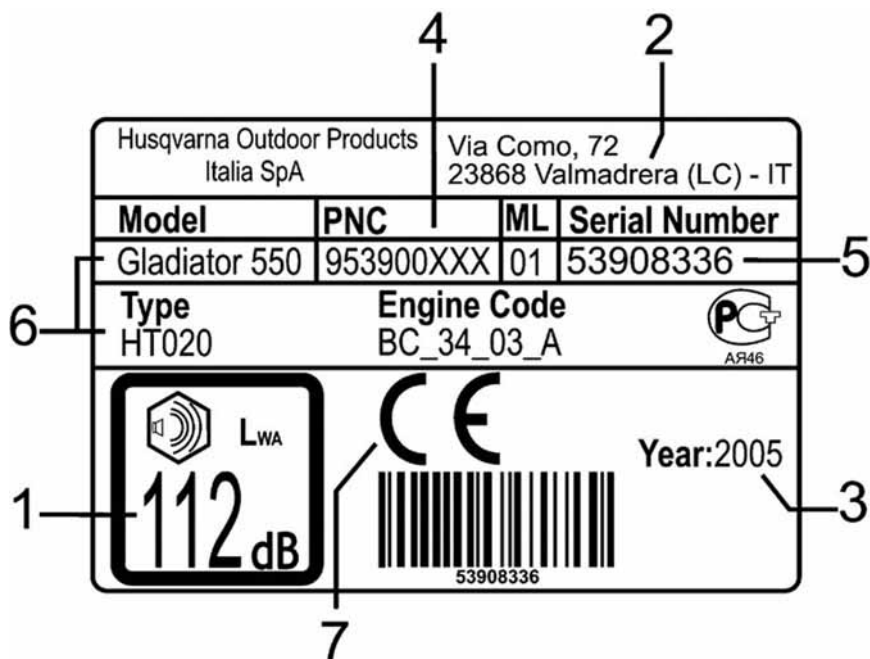

*Example of identification label*

**LEGEND:**

- 1) Guaranteed noise level according to directive 2000/14/EC
- 2) Manufacturer's name and address
- 3) Year of manufacture (last two figures; e.g. 03=2003)
- 4) Product code
- 5) Serial no.
- 6) Model/type
- 7) CE seal of conformity

## Safety precautions



### CAUTION!

Use this unit properly in order to avoid injuries.  
Follow the instructions and precautions for reasonably safe, efficient use of the product.

It is the responsibility of the user to follow the instructions and precautions provided in the manual supplied with the product.

Note the illustrations at the beginning of the manual. Every section of the text in the manual refers to the illustration bearing the same letter

## Key to symbols



Read the instruction manual carefully



Always grip the machine with two hands



Protective helmet, hearing protection, protective glasses or visor



Kickback danger



Gloves with saw protection

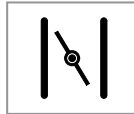

Enricher/Choke



Boots with saw protection, steel toe-cap and non-slip sole

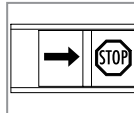

Switch off the engine by moving the stop switch to the STOP position before carrying out any checks or maintenance.



Chain brake: deactivated, activated

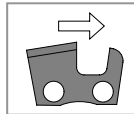

Correct direction of cutter tooth



Do not smoke when refueling or using the machine



Stopping



Caution!



Chain oil



Oil/petrol mix

## B. General safety rules



**WARNING! The saw is intended only for the cutting of wood**  
**The engine group is intended only for use with the recommended cutting equipment.**  
**WARNING! The saw can be dangerous. Improper use can cause injuries or even fatalities to the user or others.**



**Before using the machine, read the operating instructions carefully and completely and be sure to have understood all of the content.**

1. Do not use this machine if you are tired, under the effect of medicine, drugs or alcohol or in any other type of physical/mental altered state that could provoke reduced vision, dexterity or the capacity to work with potentially dangerous machinery.
2. Always wear protection accessories: approved clothing
  - Protective clothing with anti-cut protection;
  - Safety boots with anti-cut protection, steel toed with an anti-slip sole;
  - Work gloves with anti-cut protection;
  - Protective visor or glasses;
  - Protective ear protections;
  - Protective helmet to protect one from falling objects and protrusion of trees;
3. Do not wear scarves, bracelets or any object that can get struck in the machine or be dragged by the chain.
4. The saw must be used only by an adult and trained personnel;
5. Lend the machine only to expert people who know the correct use of the machine. With the machine always provide the instructions and be sure that they've been duly read and understood completely.
6. Prolonged use of the saw can expose the operator to vibrations that can produce "white finger phenomenon" (Raynaud's phenomenon). This could reduce the sensitivity of the hands in distinguishing different temperatures and cause general numbness. The operator should therefore closely check the condition of his hands and fingers if he uses the product continuously or regularly. If any of these symptoms should appear he should immediately contact a physician.
7. To guarantee maximum safety and long life of the product, use original accessories and replacement parts. We advise you to conduct regular checks and if necessary bring the saw to our authorized repair centre (see chapter on maintenance).
8. Keep people and animals far from work area, at a distance of 10 meters or twice the length of the trunk. If necessary use warning signals to keep people at a safe distance. Check that the work area is clean and clear. In your area check for any possible dangers such as: streets, paths, al cables, trees in dangerous positions etc.
9. Always pay attention to the surrounding environment and be aware of the possible dangers that couldn't be perceived due to noise emitted by this unit.
10. Never use the saw to cut at a height higher than the shoulders.
11. Hold the saw firmly during the job and always with both hands. Hold the rear grip with the right hand the front grip with the left. Always work with stable leg conditions.
12. Please make sure to be able to stop the engine in case of necessity.
13. Do not work in trees if not specially trained and equipped (straps, rope, safety hooks, etc) for this type of work.
14. Never use a defective saw or one that is not mounted and covered correctly.
15. Never use a saw that has undergone modifications that do not correspond to the original specifications.
16. The gases unloaded by the saw are poisonous. Use the saw only in areas that are well ventilated. Do not use it in closed spaces or explosive or flammable environments.
17. Never transport the saw with the motor running. To transport it, even for short distances, cover the chain with the suitable sheath (bar cover) and keep the bar turned towards the rear part. If the saw is to be transported on a motor vehicle put it in a stable position and avoid it bouncing around while checking for any loss of fuel.
18. Never touch the chain if the engine is running and even when it is off be very careful, as the teeth of the saw can cause serious injury.
19. Keep the grips clean and dry.
20. Do not use the saw if the brake chain device is defective. Do not touch the chain, even if stopped, when the saw is running.
21. Make sure that there is someone able to hear you in the event of an accident. We also recommend, to those who work in remote areas, to always carry a first aid kit and be sure that someone knows your position.
22. Always work with a fire extinguisher nearby in order to intervene in the event of a fire.
23. Do not work in bad weather conditions (rain, wind, fog etc.). Working in bad weather is often tiring and involves risky situations, slippery ground for instance. Strong winds can change the direction of falling trees causing damage to people and things.
24. Never leave the saw running when it is unattended.
25. The silencer remains very hot even after turning the engine off; do not touch the silencer if it is still hot.
26. Preserve this manual with care and always consult it before using the saw.



## C. Safety devices



**WARNING! Never use the saw if the safety devices are defective or damaged. Follow the instructions for checks, maintenance and service.**

Your saw is equipped with the following security devices:

### C1. CHAIN BRAKE WITH PROTECTION



**ATTENTION!** Your saw is equipped with a safety chain brake designed to block the chain, in case of KICKBACK, in a few milliseconds. Despite the presence of this useful safety device, the following of the security prescriptions described in this manual is fundamental.

To prevent and reduce the occurrence of a KICKBACK, always firmly grip the saw with both hands.

#### What is a KICKBACK?

1. The KICKBACK is a violent movement that causes the bar to suddenly jump up towards the operator when it meets an object with the upper part of the tip. Such a movement could cause you to lose control of the machine.
2. A KICKBACK always occurs along the blade's cutting edge. Usually the KICKBACK takes place with a sudden movement upwards, but they can happen in other situations depending on the position of the saw during cutting.
3. The KICKBACK occurs when the "risk" area of the bar meets an object.



**ATTENTION!** Work carefully and be sure that the "risk of KICKBACK" area never comes in contact with any objects..

Verify that the brake chain is working correctly and check the following on a daily basis:

4. That the chain brake (A) is disconnected when the brake lever (B) is pulled back and blocked (the chain moves).
5. The chain brake (A) is inserted when the brake lever (B) is pushed forward (the chain is blocked). The movement activates a spring device that acts on the brake ribbon (C) pushing it to block the drive system of the chain (D).



**ATTENTION!** If excessive strength is necessary to insert or disconnect the brake or neither of the positions of the lever moves **DO NOT USE THIS MACHINE ANY REASON!** Take it immediately to an authorized assistance center.

Always conduct efficiency checks on the brake before using the machine (see procedure described in the maintenance chapter)

The brake chain reduces the risk of accidents, but operator good sense can avoid them as well.

The protection doesn't serve only to activate the brake chain: it also reduces to a minimum the risk of a hand coming into contact with the chain if you lose hold of the handle.

The KICKBACK can be produced if the end part of the bar makes solid contact with the wood or other object. Therefore, you avoid beginning the cut with the part of chain at the above-mentioned angle.



**ATTENTION!** The chain brake doesn't provide total protection if the machine is operated without necessary precautions and maintenance.



**ATTENTION!** Do not dismantle or tamper with the chain brake mechanism. In the event of the machine performing poorly or replacement of some particular part, please rely exclusively upon an authorized assistance centre.

The chain brake automatically intervenes due to inertia, in the case of a violent KICKBACK.

In the event of less violent movements the chain brake is applied by the left hand. It can also be inserted manually by pushing the brake lever forward.

If the chain brake is intervened, before restarting it must be reloaded by bringing the antiKICKBACK protection back towards the front handle.



**ATTENTION! ALWAYS disengage the brake before every setting in motion of the machine in order to avoid it breaking.**

Use the brake chain as a wait brake during every moving.

### C2. THROTTLE TRIGGER LOCKOUT

The throttle trigger lockout device prevents involuntary acceleration. When the accelerator block (A) is pushed on the handle (while gripping the saw) this frees the accelerator (B). Releasing the handle, the accelerator and the accelerator block are blocked in the rest position. This mechanism is activated by two independent return springs. In this position the engine turns at a minimum.



**ATTENTION!** Never use the saw with the throttle trigger lockout device pressed with adhesive tape, string or any other means.

### C3. STOP CHAIN CATCHER

This machine is supplied with a stop chain catcher located under the pinion. The mechanism is designed to stop the movement behind the chain in the event of breaking or discharge from the bar. These occurrences are avoidable by setting the chain correctly (see chapter "D. Assembling Bar and

Chain”) Always execute correct maintenance for the bar and chain (see chapter “Maintenance”).



**ATTENTION! Never use the saw without the chain catcher.**

#### C4. REAR PROTECTION OF THE RIGHT HAND

Besides protecting the hand in the event of jumping or chain breakage, check tightness of grip of the rear handle in presence of branches.

#### C5. LESSENING VIBRATIONS

The saw is equipped with a vibration damping system that develops during the use of the saw.

The antiqiver system reduces vibration propagation between engine group/cutting group and the handles. The saw body, including cutting group, is isolated at the handles through damping elements.

#### C6. STOP SWITCH

The stop switch turns the engine off. Please ascertain that you can turn off the machine in any situation.

### D. Bar and chain assembly



**ATTENTION! Never start the saw before having mounted or regulated the chain. Wear protective gloves when mounting or regulating the chain.**  
**ATTENTION! Always remember to mount the hinge, which is indispensable for pulling down operations.**  
**ATTENTION! A chain that is too slow jumps easily and represents a danger as it can cause serious or fatal injuries.**

1. Check that the brake chain isn't activated by pulling the antiKICKBACK protection back towards the rear handle.
  2. Unscrew the nuts of the Carter clutch cover and remove the crankcase itself (brake chain). Mount the bar on the fixing pivots pushing it back as far as possible towards the clutch cover.
  3. Set the chain above the clutch cover. Make the chain pass through the groove. Begin from the upper part.
- Check that the cutting edge of the teeth is turned forward, on the upper side of the blade.
4. Chain tension is regulated through a screw (A) and a pivot (B). When the bar is mounted it's very important for the pivot located on the regulation screw to fall into line with the bar hole (C). Turning the screw, the regulation pivot of goes along the same. Identify this regulation before starting to mount the bar.
  5. Mount the Carter clutch cover (brake chain) and identify the chain tensioner on the blade. Position the hinge in the suitable location on the Carter clutch cover, in

correspondence of the 2 fixing pivots as shown in figure. Check that the chain traction teeth are taken into the wheel motor and that the chain is positioned correctly in the groove. Tighten the bar fixing nuts with your fingers.

6. Tighten the chain with the appropriate screw and combination key, screwing clockwise.
7. Simultaneously raise the tip of the bar. The tension is correct when the chain remains in the groove around the bar. The chain must furthermore be able to run with the fingers, without effort.

Tighten the two nuts, raising the tip of the bar. Always use the combination key for the assembly and setting of chain tension.

Often check the tension of a new chain, until the end of its running. A chain with correct tension means better cutting characteristics and a greater duration.

The length of the chain increases with use. Often check the tension of the chain, better with every supply opportunity.

### E. Motor and oil chain mix



**ATTENTION! The saw is equipped with a two-speed engine. Use only an oil/petrol mix. Do not use any other type of fuel if not that recommended by this manual. During all time you are in contact with the fuel smoking is strictly forbidden!**  
**All operations of maintenance, assembly, disassembly and fueling should be done with the machine on a flat, solid surface so that the motor cannot turn over, in a stable position with the motor off, the switch turned to O/STOP, the cutting tool stopped and wearing adequate protective gloves.**

#### PREPARATION OF THE MIXTURE

1. This product is supplied with a two-speed engine and it must therefore be fed with an unleaded petrol mixture (with minimum no. of octane equal to 90) and **totally synthetic oil** for two-speed engines specific for unleaded petrol in the proportions indicated in the table in cover point (D). Do not use oil for four-speed motors for any reason whatsoever.

To ensure the correct mixture, measure the quantity of oil to be mixed with petrol carefully. Dealing with a small amount of petrol, even a slight mistake in proportions of the oil has considerable importance on the percent composition of the mixture.



**ATTENTION! Carefully verify the specifications of the oil listed on the package, the use of oils**



without the specifications expressly shown in this manual, can cause serious damage to the engine!

2. Prepare the mixture in a clean can, homologated for the petrol. Prepare the mixture in an area without sources of heat or sparks and well aired also.  
To obtain the best mixture, pour the oil and then the petrol in the container before. You avoid turning over the petrol. Shake the can strongly ( repeat the operation every the fuel is taken sometimes from the can ).  
The characteristics of the mixture are subject to ageing and therefore change over time. Therefore, we recommend preparing only the quantity necessary for use. Beware of using a mixture several weeks old; it could damage the motor.

## REFUELING



**ATTENTION!** The following precautions decrease the risk of fire:

- Ensure maximum ventilation.
- Do not smoke or bring sources of heat or sparks near fuel.
- Always refuel with the motor turned off.
- Open the petrol cap with caution, to remove possible excessive pressure.
- Do not remove the petrol cap with the motor running.
- Tightly screw the cap back on after refuelling.
- Move the saw before starting it up.

Always conduct refuelling in a well-ventilated area.

3. Position the saw on a flat, solid surface, so that it can't fall over and the petrol caps are turned upward.  
To avoid impurities entering, carefully clean the inside of the tank supply pipe union before removing the cap. Open the tap of the tank with caution. Unscrew the cap of the tank containing the mixture and fill it with the necessary amount with the help of a funnel. Avoid turning over the fuel. Once the tank is filled, close the cap tightly.



**ATTENTION!** If you have spilled fuel, dry the saw well. If you have spilled some fuel on yourself, change clothes immediately. Avoid contact with skin or eyes.



**ATTENTION!** The silencer is very hot during use and soon after the stop of the engine, even if the motor was on minimum. Pay careful attention to the risk of fire especially in the presence flammable gasses or materials.

Always check that there are no fuel losses.

## CONSERVATION OF FUEL

The petrol is highly flammable. Keep it in a cool, well-aired environment stored in a container homologated for this purpose. Never leave the saw idle with fuel in the tank if the environment is not ventilated or where the gas produced by the petrol could reach flames, candles, burners, boilers, switches, al machines, water heaters, dryers etc. The gas produced by combustible items can cause explosions or fires. Never keep or store excessive amounts of fuel.

## LUBRICATION OF THE CUTTING EQUIPMENT



**ATTENTION!** Lubrication of the cutting equipment. Insufficient lubrication of the cutting equipment also causes the chain to break with heavy risk of serious or fatal personal injury.

The lubrication of the chain is insured by an automatic pump.

The mechanical oil pump for chain lubrication can be adjusted.

The feed rate of the chain oil pump can be adjusted by means of the regulating screw (see details in the illustration).

### Chain oil

It's recommended you use new oil (special type) with good viscosity. The oil for the cutting chain must offer good adhesion to the chain and good flowing properties, both in summer and winter.

Where oil for chains is not available use oil for EP 90 transmissions. Never use exhausted oils. These oils are harmful to you, the saw and the environment. It is important to use opportune oil for the temperature of the air (correct viscosity). With temperatures lower than 0 ° some oils get denser, overload the pump and damage it. For the choice of the oil contact the service workshop.

### Supplying the chain oil

4. Unscrew the cap of the chain oil tank. Fill the tank avoiding the spilling of any oil; if this occurs clean the saw well. Screw the cap back on and check there are no losses. Top it off with every supply opportunity.



**ATTENTION!** In the event of prolonged storage, empty and clean the fuel and chain oil tank. Contact the nearest supply station for the disposal of the excess fuel and oil.

## F. Starting and stopping



### ATTENTION!

- Never start the saw without mounting the chain and the Carter clutch cover. The clutch could come off and injure the operator.
- Always move the saw away from the supply area before starting it up.
- Assume a stable position and check that the chain can turn freely.
- Check there are no other people in the work vicinity.

## COLD ENGINE STARTING



**ATTENTION!** During starting, give maximum attention to the movement of the chain.

### ATTENTION!

- Do not wrap the starting cord around your hand.
- Do not suddenly leave the starting handle with the cord completely extracted, since it could damage the saw. Carry it only in the rest position.

1. Make certain that the chain brake is disconnected by pulling the lever (L) towards the front handle. Bring the stop switch to the opposite position of stop. Pull the air lever. Press the air purge diaphragm repeatedly until fuel begins to fill the diaphragm (C). The diaphragm need not be completely filled. Push the decompression valve (D) down if your models is fitted with one.
2. Firmly grip the front handle with the left hand. Place a foot on the lower part of the rear handle. Pull the cord slowly so as to activate the starting device. Give a decisive and fast pull while avoiding completely extracting the rope, which could break it. Do not suddenly let go of the starting handle. Repeat the operation until the engine crackling.
3. Bring the enricher lever back to its original position pushing it and giving a few decisive pulls until the engine has started.

4. When the motor has started, press and release the accelerator immediately so as to unlock it from the starting position.  
Let the engine heat up for not less than 10 seconds, warming the machine up allows for better cutting performance.  
If the saw doesn't start, closely repeat all of the operations.  
To avoid difficulty starting, it's strongly suggested you avoid the exhaustion of the fuel mixture in the tank; this will conserve the motor longer.

## HOT ENGINE STARTING

5. Proceed as for when the engine is cold, but without using the enricher lever. The restarting gas is obtained by pulling the enricher lever and bringing it back to the original position.

## HOT STARTING AFTER RESUPPLY

In case of complete emptying of the petrol tank and after having put the resupply in motion, follow the instructions for cold engine starting.

## STOP

6. The engine stops immediately acting on the switch.  
(In "Stop" position to the right)



**ATTENTION!** This command allows the emergency stopping of the machine.  
**ATTENTION!** Check that the chain will continue moving by its inertia also after the engine stop.

## G. Use of the saw



**ATTENTION!** The following information concerns the basic safety for working with an saw. This cannot replace experience and professionalism. In case of doubts or uncertainty, go to a trusted retailer or a professional. The pulling down of a tree requires experience and is an operation a beginner must avoid. **DO NOT DO CERTAIN JOBS WITHOUT THE NECESSARY EXPERIENCE. NEVER WORK WITH THE SAW IF YOU CAN'T GET HELP IN THE EVENT OF AN ACCIDENT.**

Carefully read the chapter concerning the "general safety rules" and the "safety devices" that come with the machine before operating it.

Avoid cutting thin branches and bushes (several branches at a time). The branches could be seized by the chain, placed in rotation and injure the operator.

## BASIC CUTTING TECHNIQUES

### General

- Always cut with the motor at the maximum number of revolutions.
- After every cut decelerate the motor (prolonged running of the engine at high speeds with the chain turning in empty space can cause heavy damage).
- Cut from high towards low = when pulling the chain.
- Cut from low towards high = when pushing the chain.

- 5.1. Consider the following five factors before preparing to cut:
  - 1 the cutting equipment must not get stuck in the cutting itself.
  - 2 the object to be cut must not separate due to breaking
  - 3 the chain must not hit the ground or other objects during and at the conclusion of cutting.
  - 4 Is there the risk of KICKBACK?
  - 5 Can the ground and any other outside factors compromise the balance of your position?



**ATTENTION!** If the saw gets stuck while cutting: **TURN THE ENGINE OFF!** Raise the trunk or move it using a robust branch or a pole as a lever. Do not try to free the saw by shaking or pulling it, thus avoiding the risk of injuring oneself with the chain or damaging the handle.

## USE OF THE SAW

The following list is a theoretical disquisition regarding the most common situations one using the saw must face.

### CUTTING

#### G2. Trunk on the ground

1. No risk of chain blocking or breaking of the trunk. Cut from top to bottom through the trunk. Proceed with caution at the end of cutting to avoid the chain hitting the ground. Maintain the maximum speed of the chain but stay prepared to face any possible surprises.  
A If possible (is it possible to turn the trunk?) Finish at 2/3 of the thickness of the trunk.  
B Rotate the trunk and cut the remaining part from top towards bottom.

#### G3. Trunk set on only one part

1. Risk of breaking during cutting  
Begin cutting from below by about 1/3 of the diameter.  
B Finish cutting from top going to meet the cut already performed.

#### G4. Trunk leaning against two extremities

1. The trunk leans against the two extremities. Risk of squashing the chain.  
Begin cutting from above by about 1/3 of the diameter.  
B Finish the cut from below going to meet the cut already executed.

### GENERAL ADVICE FOR THOSE CUTTING DOWN TREES



**ATTENTION! During pulling down operations, therefore with the bar parallel to the ground, the chain brake can be activated only by inertia.**

#### G5. Safety distance

The safety distance from the tree to be knocked down is of 2,5 times the height of the tree itself. Check that there is no one else in the danger zone before and during the cutting down.

#### G6. Direction of cutting down

The purpose of the pulling down is to make the tree fall in the best position for following cutting off of the branches and the cutting of the trunk on ground where it is possible walk without difficulty. Avoid that a falling tree gets entangled in another. Making an entangled tree fall is a very dangerous operation. After deciding in what direction you wish to have the tree fall, evaluate the natural direction of the tree's fall.

The decisive factors are:

- Inclination of the tree
- Its curvature
- Wind direction
- Concentration of branches
- The weight of any accumulated snow

Another important factor not to be neglected, one that does not affect the direction of tree's fall but rather your personal safety, is the presence of dead or broken branches which could fall off while cutting down and represent a danger.



**ATTENTION! During critical cutting down operations, raise acoustic ear protection immediately after cutting, so as to be able to perceive any unusual noises and possible warning signals.**

#### G7. Disbranching before cutting and withdrawal path

For disbranching operations the same principles apply as they do for normal cutting.

1. Remove the branches that obstruct work. Begin from bottom to top and keep the trunk between you and the saw as shown in the Fig. for avoiding the branches that can strike you. Remove the most difficult branches subsequently piece by piece. Do not operate machine at a height above the shoulders.
2. Remove the low vegetation around the tree and look for possible obstacles (stones, roots, ditches etc.) so as have a withdrawal path without obstacles.

The path should be at about 135° to the back in respect to the direction of the trunk's fall.

### FALLING THE TREE

Execute three cuts for falling. First of all the UPPER PART of the DIRECTIONAL CUT, then THE LOWER PART and then THE FALLING CUT.

The correct position of these three cuts ensures perfect control over the direction of the fall.

#### G8. Directional cut

1. First execute the UPPER PART of the directional cut on the side towards which the tree will be felled. Stay to the right of the tree and cut pulling the chain.  
Then execute the LOWER PART of the directional cut which must finish at the end of the upper part.
2. The depth of the directional cut must be 1/4 of the trunk diameter, with an angle between the upper cut and that lower than at least 45°.
3. The meeting between the two cuts is called DIRECTIONAL CUT LINE. The line must be perfectly horizontal and at a right-angle (90°) in respect to the direction of the fall.

#### G9. Tree falling cut

On the other side effect the falling cut, just beyond the line of the directional cut. Stay to the left of the tree and cut pulling the chain.

1. Position the falling cut 3-5 cm above the line of the directional cut.

#### Using the harpoon

2. The harpoon is used as a fulcrum in the cutting of trunks and the falling of trees. For correct use thrust the harpoon into the bark or the superficial part of the trunk. This is to have greater control over the direction of the cut  
Work with the chain at full speed and advance the blade slowly into the trunk. Check that the tree doesn't move in the opposite direction to that foreseen for the fall. Insert a FALLING WEDGE or a PICKLOCK as soon as possible.
3. The FALLING CUT must finish parallel to the DIRECTIONAL CUT LINE, with a distance between the two of at least 1/10 of the trunk diameter. The uncut trunk is the fulcrum.
4. The fulcrum is the hinge that drives the tree in its fall.
5. If the fulcrum is insufficient, if it has been completely sawed or if the directional cut is badly executed, controlling the fall of the tree is not possible.
6. As soon as the falling and directional cuts are completed, the tree must start falling, by itself or with the help of a PULLING DOWN WEDGE or PICKLOCK.

For the pulling down of a tree we recommend using a bar longer than the diameter of the trunk, so as to be able execute the DIRECTIONAL and FALLING cuts with a SIMPLE CUT (see "technical characteristics" for the recommended length of the bar).



**ATTENTION!** We advise against operators with less experience falling trees with a blade shorter than the diameter of the trunk!

## G10. DISBRANCHING



**ATTENTION!** Most accidents caused by saw KICKBACK happen during the disbranching process.

**Observe the position of the blade tip during the cutting of branches in tension.**

Keep a stable position. Work from the left side of the trunk, with the body near the saw. As soon as possible lean all the weight of the body against the trunk.

## H. Carburettor



**ATTENTION!** Never start the saw without the blade, chain or clutch cover. The clutch can otherwise separate and cause injuries.

**ATTENTION!** During use and immediately after stopping the engine the silencer reaches very high temperatures.

**Avoid the contact with these waves to avoid burns. Lend the maximum attention to the danger of fire especially in presence of flammable materials or gases.**

**ATTENTION!** It is advisable to regulate the carburettor at an authorized assistance centre. The regulation of the carburettor is fundamental and if executed incorrectly it can seriously damage the unit.

### H1. WORKING OPERATION

- Through the accelerator the carburetor regulates the number of motor revolutions. The mixing of air and petrol occurs in the carburetor. This mixing can be controlled. To be able to better exploit the power of the saw, the carburetor regulation must be correct.
- The T screw regulates the accelerator position to the minimum. Screwing clockwise the slower RPMs rise while turning anticlockwise the lower RPMs are reduced.

The carburettor is set up and tested in the factory. Normally it shouldn't need any regulation. If the conditions that affect the working of the carburettor should be such as to require a new regulation, closely follow the following instructions.

Before executing any regulation, check that the air filter is clean and that the cylinder is in place.

### FINAL REGULATION OF THE T MINIMUM

The regulation of the minimum is executed with the T screw. If necessary, screw the T clockwise with the motor running until the chain starts to turn. Then unscrew counter clockwise until the chain stops. The minimum is correctly regulated when the motor turns regularly in every position and with a good margin before the chain starts turning.

In case of doubts or questions contact an authorized assistance centre.

### REGULATION



**ATTENTION!** During regulation of the carburetor pay particular attention to the moving chain in that it could provoke injuries.

Regulating the carburettor means conforming the engine to the local climatic conditions, the available petrol and the type of two-speed engine used.

## I. Maintenance of safety devices



**ATTENTION!** Closely follow the maintenance instructions shown in this manual. During maintenance operations the saw must be turned off. Start the motor only when a procedure requires it and it follows safety norms.

**ATTENTION!** Do maintenance checks to safety devices before using the saw. If the saw doesn't pass one of the checks shown here do not use it under any circumstances. Contact an authorized assistance centre listed on the packaging of the saw.



## 11. Brake chain with antiKICKBACK protection



**ATTENTION! Do not dismantle or tamper with the chain brake mechanism under any circumstances. In the event of improper functioning or need to replace a part, go only to an authorized assistance centre.**

1. Periodically clean the clutch brake and drum removing sawdust, resin and dirt (without dismantling the brake) and visually check the ribbon wear and tear (if the band brake thickness is less or equal to 0.60 mm at the point of greatest use rely upon an assistance centre authorized for the replacement).
2. Check that the protection is complete and without evident defects such as cracks in the material.
3. Move the protection back and forth to verify that it moves freely and that you're anchored well in the clutch cover.
4. Start up the saw on a stable base. See that the chain turns freely.
5. Grip the handles with both hands.
6. Accelerate activate chain brake using the left hand antiKICKBACK button without letting go of the handles. The chain must block immediately (to avoid breaking the brake itself, don't insist with the accelerator).

## 12. Accelerator Block

1. Check that the accelerator is blocked at the minimum when in rest position.

2. Press the throttle trigger lockout device and check that it goes back to rest position as soon as it's released.
3. Check that the accelerator and the accelerator block move freely and that the recall springs work correctly.
4. Start up the machine and go to maximum speed. Release the accelerator and check that once the chain is still it doesn't move. If the chain moves, check the minimum regulation (see "Regulation of the carburettor").

## 13. Chain Brake Pivot

Check that the chain stop pivot is complete and well mounted on the saw.

## 14. Rear right hand protection

Check that the protection of the right hand is complete and without any obvious faults such as damaged material.

## 15. Vibration Dampening System

Check the proper working of the dampers and that aren't deformed or damaged in any way.

Check that they're anchored between the engine group and handle group.

## 16. Stop switch

Start up and check that motor shuts off bringing the switch to the stop position.

# L. Periodic maintenance

## CHAIN SHARPENER AND CONTROL OF CUTTING DEPTH



**ATTENTION! If the chain isn't sharpened correctly, risk increases as a consequence.**

**The following instructions refer exclusively to the recommended chain. Always sharpen the chain with motor turned off.**

### L1 General instructions on sharpening the chain.

The chain must always be well sharpened. If the chain doesn't cut without having to press the bar against the wood and produces very fine sawdust, it is a sign the chain is not sharp. If the cutting doesn't produce sawdust, the chain has completely lost its thread and in cutting you pulverize the wood. If the chain is sharp, it moves forward in the wood itself and produces big and long shavings.

1. The sharp part of the chain is made up of the CUTTING MESH, with a TOOTH (A) and POINT FOR THE CUTTING DEPTH (B). The difference in level between these two determines the cutting depth.

### L2 Sharpening of the teeth



**ATTENTION! The following deviations from the instructions for sharpening considerably increase the tendency of KICKBACK:**

- EXCESSIVE SHARPNESS ANGLE
- INSUFFICIENT SHARPNESS ANGLE
- INSUFFICIENT FILE DIAMETER

To obtain good sharpness of the chain you need A FILE GUIDE and A ROUND FILE. The diameter of the file must be equal to 3/16" /4,8mm.

Place the chain on the bar and stretch it using the chain tensioner and checking that the chain has the correct tension and that it's blocked with the safety brake. This impedes that chain moves sideways making the sharpening operation more difficult.

1. Always sharpen the cutting tooth from the inside towards the outside, slackening the pressure on the file during the return phase.

The operation will be easier using the file guide.

During sharpening the file must be positioned so as determine the following three corners of the cutting:

"A" upper angle 30° - 35°

"B" external side angle 85° - 90°

"C" internal side angle 60°

2. The file must be positioned and must work perpendicularly to the bar.
3. To obtain more precise side angles we advise positioning the file so that you vertically cross over the cutting edge of about 0,5 mm.

Sharpen all the teeth of one side first then turn the saw over and repeat the operation.

To obtain a uniform cutting surface in the wood, all the teeth must be sharpened to the same length.

### 4. CUTTING DEPTH DELIMITER

With the sharpness of the teeth the cutting depth decreases. Check the height of the depth delimiters after various chain sharpenings.

The exact height must be 0,025"/0,65 mm beneath the upper cutting edge.

Check the height using the file and file down the jutting part. Round the front part of the delimiter (D).

### L3 DAILY MAINTENANCE



**ATTENTION! Please be sure that the engine is switched off before beginning any maintenance operation.**

**Air Filter** Clean the air filter at least once a day and more often in difficult environments. Remove the filter as shown in the figure and clean it using a gentle jet of compressed air. For more thorough cleansing, you can wash it with soapy water.

During assembly, check that the filter closes well into its area. The filter never becomes again completely clean and must therefore be periodically replaced with a new one.

A damaged filter must be replaced immediately.

**M1 Cutting Bar** Carefully clean the oil passage flue (K) and holes (I). Turn the bar periodically to obtain uniform performance in the event the guide groove is worn or there are excessive furrows present. Clean the chain guide. Grease the bar coil with fat for bearings.

**M2 Chain Oil Pump** Check that the automatic pump for bar lubrication correctly pumps chain oil. Point the bar against a clear surface, about twenty centimetres distant. After about a minute, at  $\frac{3}{4}$  gas, the surface will have to present clear oil tracks. If the pump doesn't work correctly contact an Authorized Assistance Centre.

### Fuel Filter

To replace remove the tank cap and extract the filter using a metal hook. Replace the filter, preferably at least once a year.

**M4 Chain** Sharpen the chain and check its condition and tension. If it is worn-out, have it replaced at an authorized assistance centre. When the cutting tooth is only 4 mm, the chain is worn and must be replaced.

### M3 Chain Drag Coil

Check that the chain drag coil is not worn. If the replacement is necessary, refer to an authorized assistance dealer.

**L4 Starting Device** Check the starting device, the cord, and clean the outside air intake. Check that the cord automatically returns to its original position.



**ATTENTION! In the starting device a tension spring is present. Do not open the device to avoid personal injury. If the starting device turns out to be defective, contact an authorized assistance centre for repairs.**

### Nuts and screws

Check that all nuts and screws are well tightened.

### L4 Spark Plug

Clean the spark plug and check that the electrode has a distance of 0.5 mm. Replace it if it is worn, using the suitable key for the job.



**ATTENTION! In the event sparkplug replacement is necessary, use only the correct type of spark plug as its replacement. Other types could damage the engine.**

## Technical data

### Engine

Cubic capacity cm <sup>3</sup>	46	49	51
Bore (mm)	43	44	45
Stroke(mm)	32	32	32
Revolutions per minute (min-1)	2500	2500	2500
Recommended maximum revolutions (min-1)	12500	12500	12500
Power (kW@rpm) (ISO7293)	2,2/9000	2,3/9000	2,5/9000

### Ignition

Make/type of the ignition	Walbro / Phelon - Electronic
Plug	Champion RCJ7Y / NGK BPMR7A
Plug gap (mm)	0,6 - 0,7

### Fuel, lubrication

Type carburettor	Walbro WT 738 / ZAMA C1Q-X5054
Petrol tank capacity (cm <sup>3</sup> )	450
Oil tank capacity (cm <sup>3</sup> )	200
Weight (without bar, dry) (kg)	4,9

### Combinations of bar and chain

Max number of teeth on sprocket	6	-	-
Chain pitch (inch)	3/8"	-	-
Length (inc/cm)	14"/35	-	-
	16"/40	-	-
	18"/45	-	-
Chain speed at max. power (m/sec)	17,7	-	-
Thickness of mesh traction (mm)	1,3	-	-

Max number of teeth on sprocket	7	7	7
Chain pitch (inch)	0,325"	0,325"	0,325"
Length (inc/cm)	13"/33	13"/33	13"/33
	15"/38	15"/38	15"/38
	18"/45	18"/45	18"/45
Chain speed at max. power (m/sec)	19	19	19
Thickness of mesh traction (mm)	1,3	1,3	1,3

### Noise level

Sound pressure equivalent to the ear of the operator in dB(A) (ISO 22868)	99,5	99,5	100
Guaranteed sound power level LwAav dB(A) (ISO 9207). .	110	110	109
Measured sound power level LwAav dB(A) (ISO 9207). .	109	109	108

### Vibration level

Front handle (m/s <sup>2</sup> ) aw, av (ISO 22867)	5,1	5	3,2
Rear handle (m/s <sup>2</sup> ) aw, av (ISO 22867)	8,7	8,5	9,5

### EC declaration of conformity (Only applies to Europe) (Directive 98/37/EC, Annex II, A)

We, H.O.P.I. Via Como 72, 23868 Valmadrera (LC) Italia, declare under sole responsibility that the chain saws **CS020** from 2007's serial numbers and onwards (the year is clearly stated in plain text on the type plate with subsequent serial number), are in conformity with the following standards or other normative documents following the provisions in the COUNCIL'S DIRECTIVES: - of 22/6/1998 "relating to machinery" **98/37/EC** and applicable supplements; - of 15/12/2004 "relating to electromagnetic compatibility" **2004/108/EC**, and applicable supplements; - of 8/6/2000 relating to the noise emissions in the environment **2000/14/EC, 97/68/EC + 2002/88/EC** gas emission.

For information relating to noise emissions, see chapter Technical data.

The following harmonised standards have been applied: **ISO 11681-1:2004 + A1:2007, EN ISO 14982:1998**. The supplied chain saw conforms with the example that underwent EC type examination. The certificates are numbered: 0710002.

Registered body: 0717, Nemko S.p.A. - Via Trento e Trieste, 116 - I-20046 Biassono (MI), has carried out EC type examination in accordance with article 8 section 2c.



Valmadrera, 01.06.07  
Ing. De Carlo Raffaele (Direttore Tecnico)  
H.O.P.I.