

Husqvarna Outdoor Products Italia SpA
Via Como, 72
23868 Valmadrera LC
ITALIA
Phone +39 0341 203111 - Fax +39 0341 581671



GB

INSTRUCTION MANUAL

IMPORTANT INFORMATION: Please read these instructions carefully and make sure you understand them before using this unit. Retain these instructions for future reference.

DE

BETRIEBSANWEISUNG WICHTIGE INFORMATION:

Lesen Sie diese Hinweise zur Handhabung des Geräts aufmerksam durch. Verwenden Sie es erst, wenn Sie sicher sind, daß Sie alle Anweisungen verstanden haben und gut aufbewahren.

FR

MANUEL D'INSTRUCTIONS RENSEIGNEMENTS

IMPORTANT: Avant d'utiliser cet appareil, veuillez lire attentivement les instructions et assurez-vous de les avoir comprises. Conservez les instructions pour référence ultérieure.

NL

HANDLEIDING

BELANGRIJKE IMPORTANTS: Lees deze handleiding aandachtig en zorg dat u alles begrijpt alvorens de kettingzaag te gebruiken en be-waar ze voor toekomstige raadpleging.

NO

BRUKERHÅNDBOK

VIKTIG INFORMASJON: Les disse anvisningene nøye og forsikre deg om at du forstår dem før du bruker enheten og oppbevar dem for sen-ere bruk.

FI

OHJEKIRJA

TÄRKEÄ TIETOA: Lue nämä ohjeet huolellisesti ja varmista, että olet ymmärtänyt ne, ennen kuin alat käyttää tätä laitetta ja säilytä myöhempää tarvetta varten.

SE

BRUKSANVISNING

VIKTIG INFORMATION: Läs instruktionerna noggrant och försäkra dig om att du förstår dem innan du använder utrustningen och spara dem för framtida behov.

DK

BRUGERHÅNDBOG

VIGTIGE OPLYSNINGER: Læs instruktionerne omhyggeligt, før du bruger enheden og gemme til senere henvisning.

ES

MANUAL DE INSTRUCCIONES

INFORMACIÓN IMPORTANTE: Lea atentamente las instrucciones y asegúrese de entenderlas antes de utilizar esta aparato. Conserve las instrucciones para la referencia en el futuro.

PT

MANUAL DO OPERADOR

INFORMAÇÕES IMPORTANTES: Queira ler cuidadosamente estas instruções e tenha certeza de entendê las antes de usar a serra e guarde para consulta futura.

IT

LIBRETTO D'ISTRUZIONI

INFORMAZIONI IMPORTANTI: Leggere le istruzioni attentamente e capirle bene prima di usare l'utensile. Conservare per ulteriore consultazione.

HU

HASZNÁLATI ÚTMUTATÓ

Jótállást vállalni csak rendeltetésszerűen használatba vett gépekre tudunk. Kérj ü hogy a gép használatba vétele előtt gondosan olvassa el a kezelési utasításokat.

GR

ΕΓΧΕΙΡΙΔΙΟ ΧΕΙΡΙΣΜΟΣ ΣΗΜΑΝΤΙΚΕΣ

ΠΛΗΡΟΦΟΡΙΕΣ: Διαβάστε προσεκτικά αυτές τις οδηγίες και φροντίστε να τις κατανοήσετε αυτό το μηχάνημα και φυλάξτε το για να το συμβουλευέστε στο μέλλον.

CZ

NÁVOD K POUŽÍVÁNÍ DŮLEŽITÁ INFORMACE!

Než začnete stroj používat přečtěte si prosím velmi pozorně tyto instrukce a ujistěte se, že jste jim porozuměli. Uschovejte si tento návod pro použití i v budoucnu.

PL

INSTRUKCJA OBSŁUGI

Gwarancja traci ważność w przypadku użycwania urządzenia do celów innych niż wymienione w instrukcji obsługi. Prosimy o uważne przeczytanie instrukcji oraz o stoowanie się do zaleceń i wskazówek w niej zawartych.

SK

NÁVOD NA OBSLUHU Dôležitá informácia:

Pred použitím stroja si starostlivo prečítajte tento návod na obsluhu a uistite sa že ste mu dôkladne porozumeli. Návod starostlivo uschovajte pre potrebu v budúcnosti.

RU

ИНСТРУКЦИИ ВАЖНЫЕ СВЕДЕНИЯ:

Внимательно прочитайте инструкции и хорошо их понять, перед тем как пользоваться блоком. Хранить инструкции для дальнейших консультаций.

EE

KASUTUSJUHEND TÄHTIS INFORMATSIOON:

Lugege kasutusjuhend enne seadme kasutamist kindlasti põhjalikult läbi ning veenduge, et olete kõigest täpselt aru saanud.

LV

ROKASGRĀMATA SVĀRĪGA INFORMĀCIJA:

Pirms ierīces izmantošanas uzmanīgi izlasiet rokasgrāmatu un pārlicinieties, ka jūs ļābi saprotat tās saturu. Saglabājiet rokasgrāmatu, lai nākotnē būtu iespējams atsvaidzināt jūs zināšanas.

TR

KULLANMA KYLAVUZU ÖNEMLİ TALİMATLAR:

Buradaki bilgiler dikkatlice okuyunuz ve aleti kullanmaya başlamadan önce tüm talimatların tarafınızdan anlaşılmsı olduğundan emin olunuz. Gerektiği zaman başvurabilmeniz için saklayınız.

GB Due to a constant product improvement programme, the factory reserves the right to modify technical details mentioned in this manual without prior notice.

DE Im Sinne des Fortschritts behält sich der Hersteller das Recht vor, technische Änderungen ohne vorherigen Hinweis durchzuführen.

FR La Maison se réserve la possibilité de changer des caractéristiques et des données de ce manuel à n'importe quel moment et sans préavis.

NL Door konstante produkt ontwikkeling behoud de fabrikant zich het recht voor om technische specificaties zoals vermeld in deze handleiding te veranderen zonder hiervan vooraf bericht te geven.

NO Produsenten forbeholder seg all rett og mulighet til å forandre tekniske detaljer i denne manualen uten forhåndsvarsel.

FI Jatkuvan tuotteen parannusohjelman tähden valmistaja pidättää oikeuden vaihtaa ilman ennakkovaroitusta tässä ohjekirjassessa mainittuja teknisiä yksityiskohtia.

SE Tilverkaren reserverar sig rätten att ändra fakta och uppgifter ur handboken utan förvarning.

DK Producenten forbeholder sig ret til ændringer, hvad angår karakteristika og data i nærværende instruktion, når som helst og uden varsel.

ES La firma productora se reserva la posibilidad de cambiar las características y datos del presente manual en cualquier momento y sin previo aviso.

PT A casa productora se reserva a possibilidade de variar características e dados do presente manual em qualquer momento e sem aviso prévio.

IT La casa produttrice si riserva la possibilità di variare caratteristiche e dati del presente manuale in qualunque momento e senza preavviso.

HU A gyártó cég fenntartja a jogot arra, hogy a használati utasításban megadott adatokon és technikai tulajdonságokon bármikor és előzetes bejelentés nélkül változtasson.

GR Λόγω προγράμματος συνεχούς βελτίωσης προϊόντων, το εργοστάσιο επιφυλάσσειται του δικαιώματος να τροποποιεί τις τεχνικές λεπτομέρειες που αναφέρονται στο εγχειρίδιο αυτό χωρίς προηγούμενη ειδοποίηση.

CZ Vzhledem k pokračujícím inovacím si výrobce výrazuje právo mínit technické hodnoty uvedené v této příručce bez předchozího upozornění.

PL W związku z programem ciągłego ulepszania swoich wyrobów, producent zastrzega sobie prawo do wprowadzania zmian w szczegółach technicznych wymienionych w tej instrukcji bez uprzedniego zawiadomienia. Instrukcja jest częścią wyposażenia.

SK Proizvajaec si pridružuje pravico, da spremeni značilnosti in podatke pričujočega priročnika v katerem koli trenutku in brez predhodnega obvestila.

RU Компания производитель сохраняет за собой право изменять характеристики и данные в настоящем руководстве, в любой момент и без предварительного извещения.

EE Tootja jätab endale õiguse muuta käesolevas kasutusjuhendis kirjeldatud omadusi ja andmeid suvalisel hetkel ja sellest eelnevalt ette teatamata.

LV Izgatavotājs saglabā tiesības jebkurā brīdī un bez brīdinājuma mainīt šajā rokasgrāmatā esošos datus un raksturlieknes.

TR Üretici firma bu kullanma kılavuzunda yer alan özellik ve verilerin istediği zamanda ve haber vermeksizin değiştirilme hakkını kendinde sahip tutar.

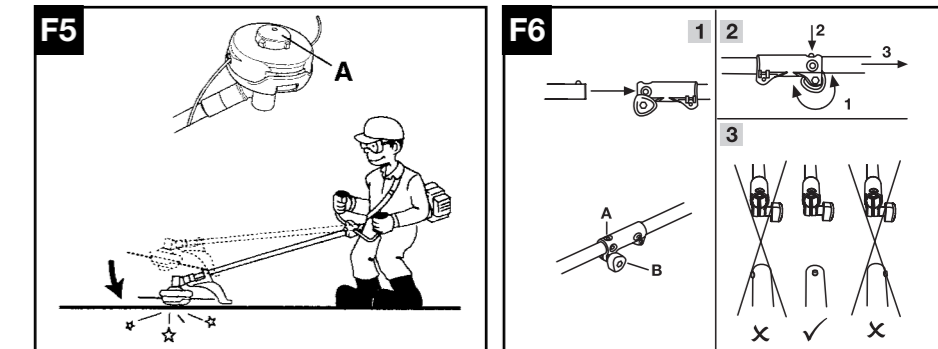
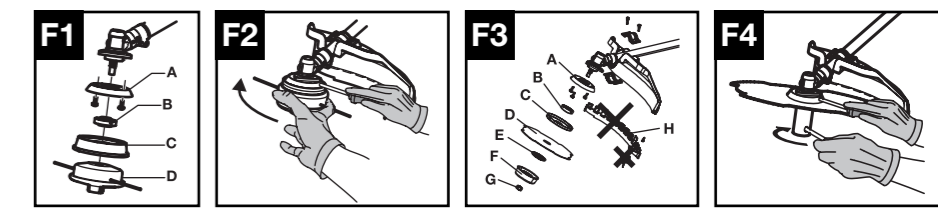
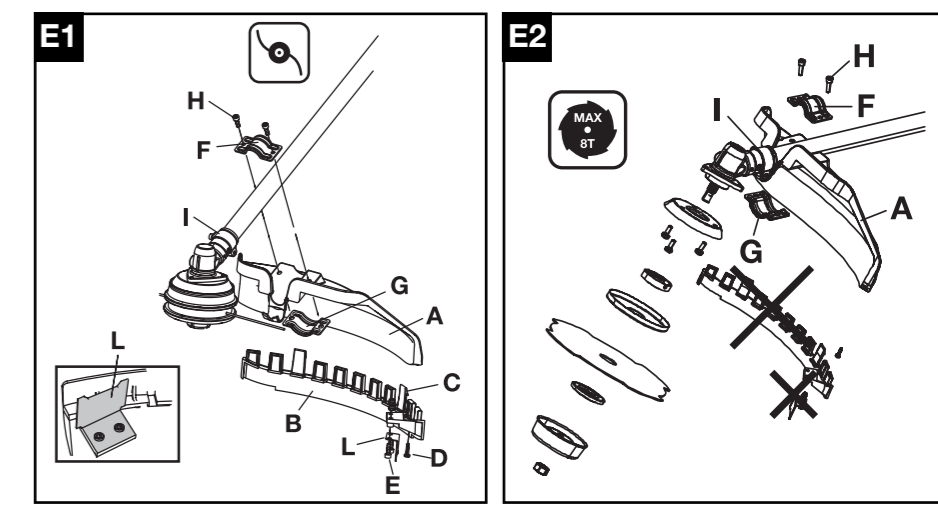
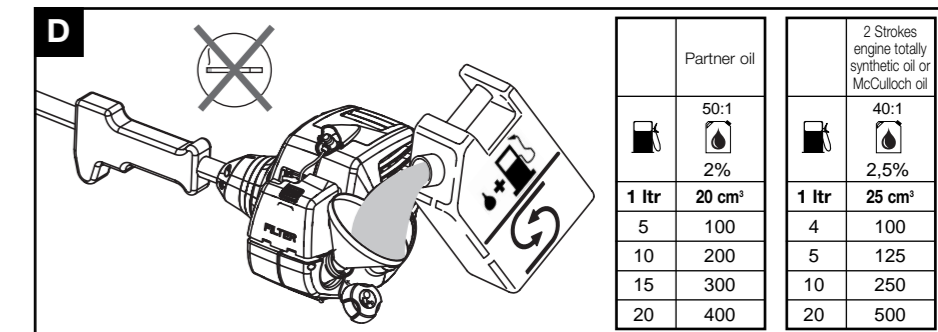
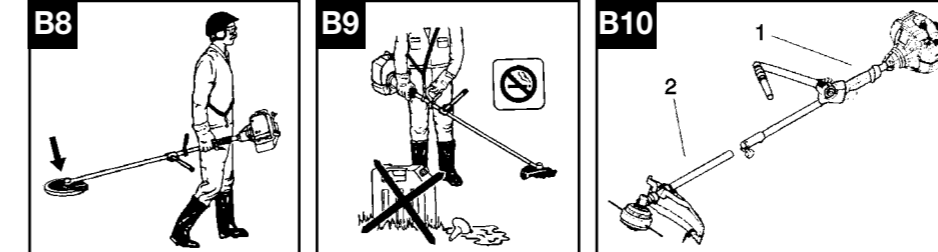
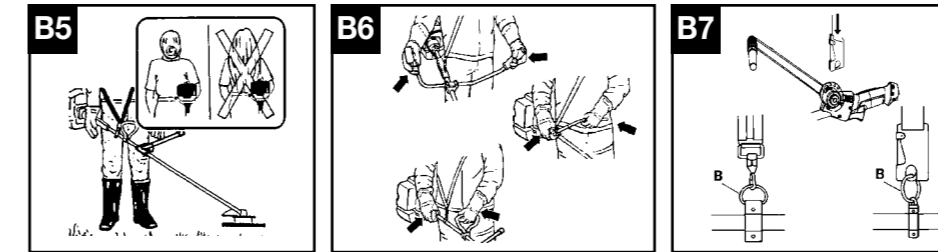
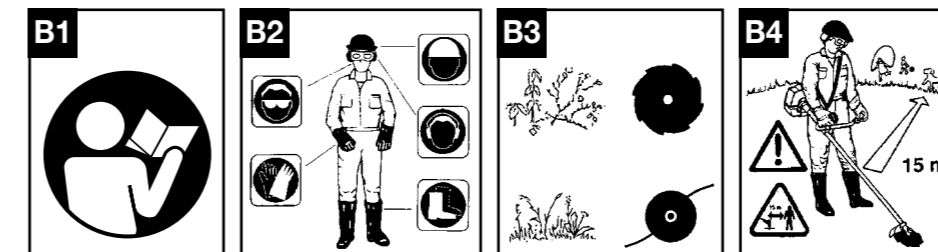
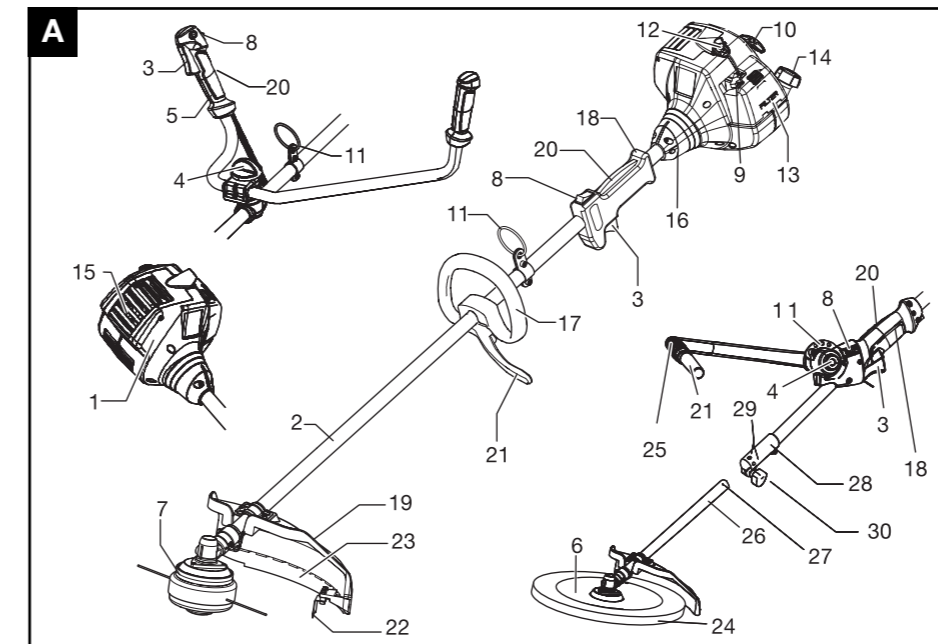

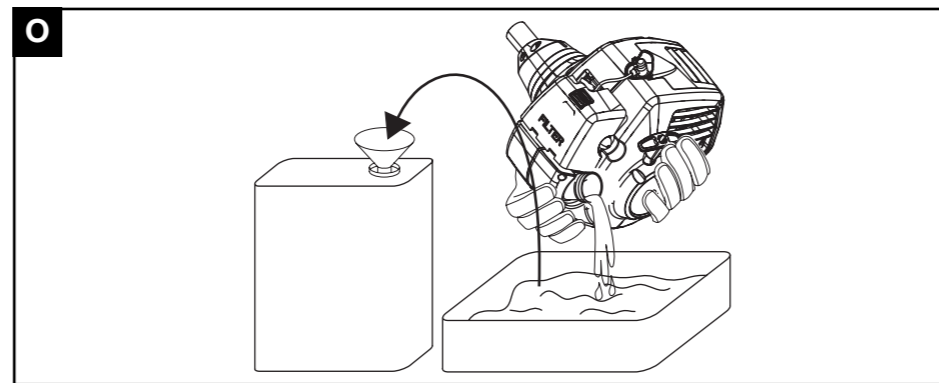
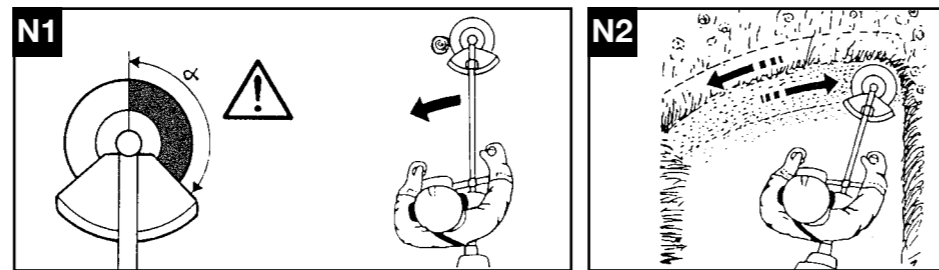
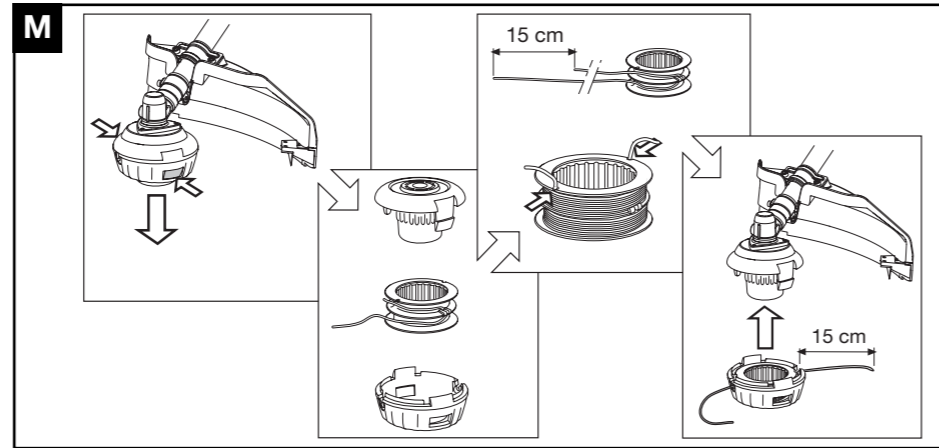
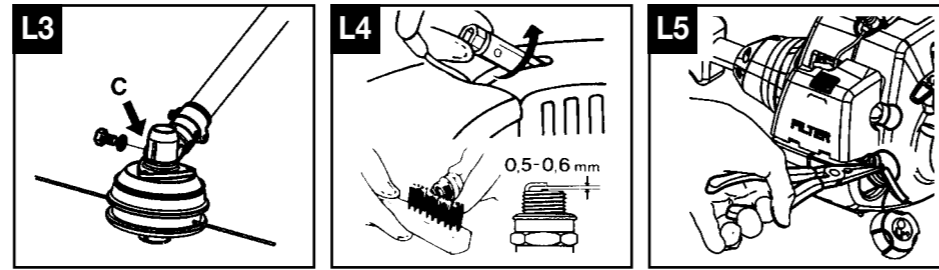
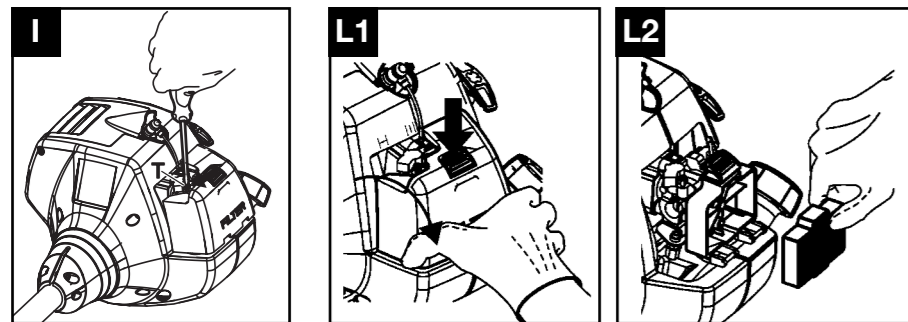
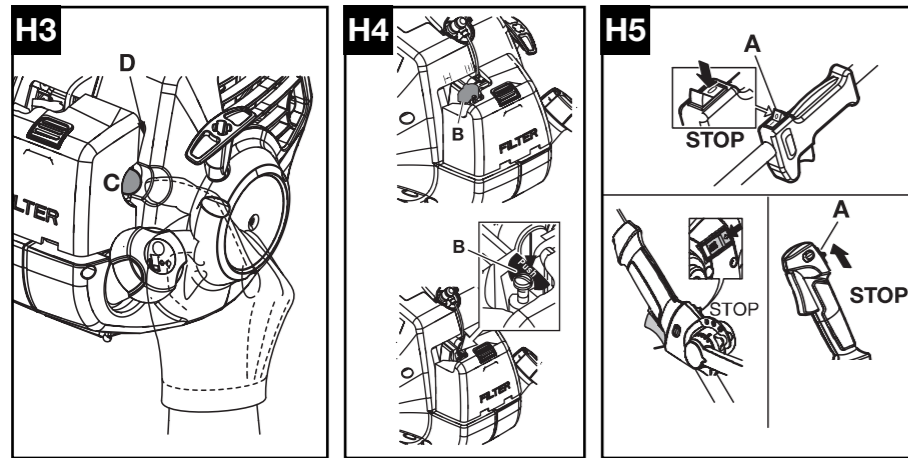
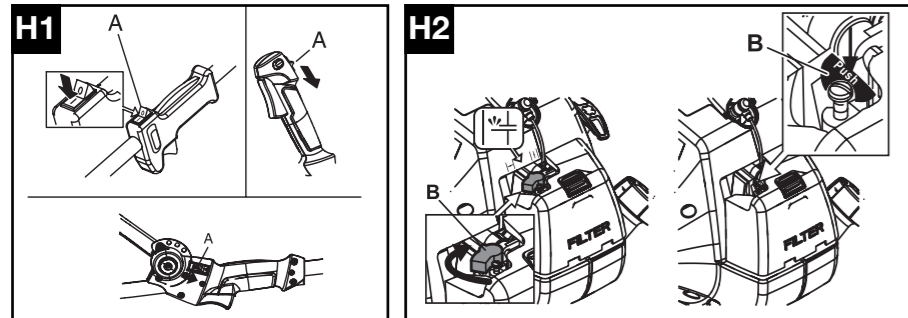
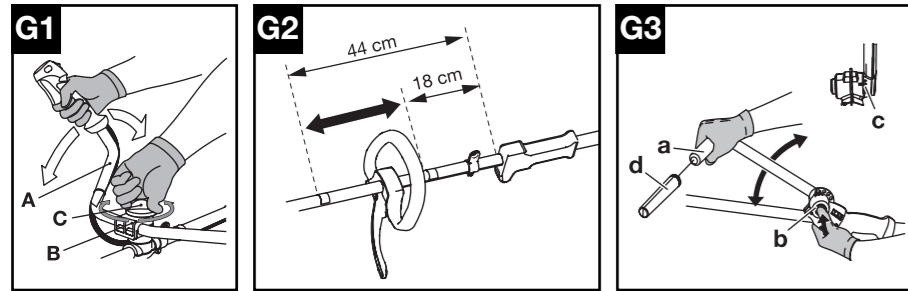

	0,095" 2.4mm	197" 5000mm	531025001
			538249155
	4T	9" 230 mm	531024905
			538249155
	4T	10" 255 mm	531024902
			538249155
	8T	9" 230mm	531024906
			538249155
	8T	10" 255mm	531024903
			538249155

- GB** SUMMARY CHART TO IDENTIFY THE CORRECT GUARD NEEDED, WITH DIFFERENT CUTTING ATTACHMENTS
- DE** ÜBERSICHTSTABELLE ZUR AUSWAHL DES RICHTIGEN SCHUTZBLECHES FÜR DIE EINZELNEN SCHNEIDWERKZEUGE
- FR** TABLEAU RECAPITULATIF POUR LE CORRECT ACCOUPLEMENT LAME OU TÊTE FIL NYLON / DEFENSE DE SECURITE
- NL** OVERZICHTSTABEL OM TE BEPALLEN WELKE BESCHERMKAP GEBRUIKT MOET WORDEN BIJ DE DIVERSE MAAI-ONDERDELEN
- NO** TABELL FOR KORREKT MONTERING AV TRÅD-SPOLE/SAGBLAD OG SPRUTSKJÆRM/SIKKERHETSVÆRN
- FI** TAULOKKO LEIKKAAVAN PÄÄN/TURVASUOJUKSEN OIKEASTA YHDISTELMÄSTÄ
- SE** SAMMANFATTANDE TABELL ÖVER KORREKT KOMBINATION AV SKÄRHUVUD/SÄKERHETSSKYDD
- DK** OVERSIGTSTABEL VEDRØRENDE DEN KORREKTE SAMMENSÆTNING AF KNIV OG BESKYTTELSSESKÆRM
- ES** TABLA PARA EL CORRECTO ACOPLAMIENTO DE LA CABEZA CORTANTE Y PROTECTOR DE SEGURIDAD
- PT** TABELA DE RESUMO PARA A CORRETA APLICAÇÃO DA CABEÇA CORTANTE E DEFESA DE SEGURANÇA
- IT** TABELLA RIASSUNTIVA PER IL CORRETTO ABBINAMENTO TESTA TAGLIANTE / DIFESA DI SICUREZZA
- HU** ÖSSZEFOGLALÓ TÁBLÁZAT: A NYÍRÓFEJ ÖSSZEÁLLÍTÁSA / BALESETVÉDELEM
- GR** ΠΕΡΙΛΗΠΤΙΚΟΣ ΠΙΝΑΚΑΣ ΓΙΑ ΤΗΝ ΕΠΙΣΗΜΑΝΣΗ ΤΟΥ ΚΑΤΑΛΛΗΛΟΥ ΠΡΟΦΥΛΑΚΤΗΡΑ, ΜΕ ΔΙΑΦΟΡΑ ΚΟΠΤΙΚΑ ΕΞΑΡΤΗΜΑΤΑ
- CZ** SHRNUJÍCÍ TABULKA PRO SPRÁVNOU KOMBINACI REZNÁ HLAVA/BEZPEČNOSTNÍ OCHRANA
- PL** TABELA ZBIORCZA POPRAWNEGO ZESTAWIENIA GŁOWICY TNAŃCZĄJ / OSŁONY ZABEZPIECZAJĄCEJ
- SK** TABELA – POVZETEK ZA PRAVILNO POVEZAVO GLAVA/ ZASCITA
- RU** ОБЗОРНАЯ ТАБЛИЦА ДЛЯ ПРАВИЛЬНОГО СОЧЕТАНИЯ РЕЖУЩЕЙ ГОЛОВКИ / ПРЕДОХРАНИТЕЛЬНОГО УСТРОЙСТВА
- EE** KOKKUVÕTLIK TABEL TRIMMIPĒA JA SELLE KAITSME KORREKTSEKS MONTEERIMISEKS
- LV** NOSLĒGUMA TABULA PAREIZAI GRIEŠANAS GALVIŅAS UN DROŠĪBAS AIZSARGA SAVIENOŠANAI
- TR** DOĞRU BİR GİYİM ŞEKLİ İÇİN ÖZETLEYİCİ TABELA KESİCİ KAFA / EMNİYET KORUNMASI

A. General description

- 1) ENGINE
- 2) SHAFT
- 3) THROTTLE TRIGGER
- 4) GRIP ADJUSTMENT KNOB
- 5) RIGHT CONTROL HANDLE
- 6) BLADE
- 7) NYLON STRING HEAD
- 8) STOP SWITCH
- 9) FUEL ENRICHMENT LEVER
- 10) STARTER HANDLE
- 11) HARNESS RING
- 12) SPARK PLUG
- 13) AIR FILTER COVER
- 14) FUEL TANK CAP
- 15) MUFFLER SHIELD
- 16) ENGINE/SHAFT JOINT
- 17) DELTA HANDLE
- 18) REAR CONTROL GRIP
- 19) SAFETY GUARD
- 20) SAFETY LEVER
- 21) SAFETY POLE GUARD
- 22) STRING CUTTER BLADE
- 23) NYLON STRING HEAD GUARD EXTENSION
- 24) BLADE GUARD
- 25) FRONT HANDLE
- 26) ATTACHMENT
- 27) LOCKING PIN
- 28) SHAFT / ATTACHMENT JOINT
- 29) LOCKING PIN HOUSINGS
- 30) JOINT KNOB

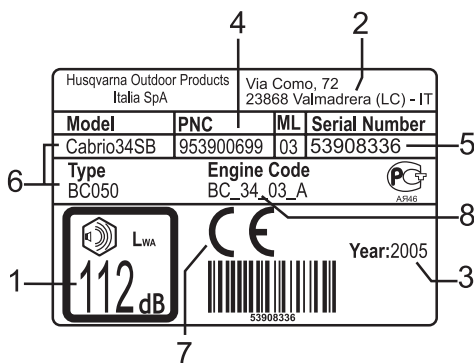

Example of identification label

LEGEND:

- 1) Guaranteed noise level according to directive 2000/14/EC
- 2) Manufacturer's name and address
- 3) Year of manufacture
- 4) Product code
- 5) Serial no.
- 6) Model/type
- 7) CE marking of conformity
- 8) Displacement

B. Safety precautions

Explanation of Symbols



Warning



Safety apparel: Approved gloves.



Safety apparel: Approved protective goggles or visor, approved hard hat and hearing protection.



Safety apparel: Approved boots.



Read the instructions for the user carefully and make sure you understand how all the controls work.



Do not smoke when refueling or using the machine.



Fuel enrichment (starting aid).



Maximum shaft speed.



Danger of flying debris.



Danger of kickback. The blade is capable of amputating arms and legs.



Minimum safety distance 15m.



CAUTION!

Danger of serious leg injuries. Take scrupulous care to follow the instructions in the manual.



Emergency stop.



CAUTION!

The cutting parts and muffler may get very hot and cause burns. Wait a few minutes before touching them.

Prior to use

- Do not use this machine for any other purpose than that for which it was designed, using the proper cutting devices as indicated in the instructions.
- **B1.** Anyone who uses the machine should have read the entire manual with extreme care.
- Make sure you know how to stop the engine and blade if necessary (see section entitled "*Starting and stopping the engine*").
- All users should be familiar with the operations for use of the machine under absolutely safe conditions as described in this manual, and should be instructed in the proper cutting techniques to use, possibly by practical demonstration.
- Do not use the machine if you are tired, in poor health or under the effects of alcohol or medication that could affect your reactions.
- Do not allow children or persons who are not familiar with these instructions and are not sufficiently trained to use the brush cutter. Local regulations may specify an age limit for users.
- Keep this manual with the machine when selling or lending it, to enable the future users to familiarize themselves with the product and instructions for safe use.
- Always inspect the machine carefully prior to use: make sure it is correctly assembled and that there are no loose screws, damaged parts, fuel leaks.
- Replace any accessories (blades, nylon string heads, guards) which show damage or cracks or appear excessively worn. Have your Authorized Service Center replace any damaged parts.
- Perform all operations of maintenance and/or assembly ONLY with the engine off and wearing gloves.

Apparel

- **B2.** Dress suitably for the job; wear approved personal protection gear: a) Close-fitting clothing (no shorts or loose clothes). b) Safety boots with non-slip sole, crush-resistant toe cap and protection against cuts (do not wear sandals or work barefoot). c) Sturdy gloves

resistant to cuts and vibrations. d) Safety visor or protective goggles. Remove the protective film if any. e) Hearing protection. The use of personal protection gear does not eliminate the risk of injury but may reduce the effect of the damage in case of accidents.

- Do not wear loose clothing or jewelry that could get caught in the moving parts of the machine.
- Watch out for the rotating parts and hot surfaces of the machine.

Health precautions



CAUTION! Avoid prolonged use. Noise and vibrations may be dangerous.

- Prolonged use of the machine or other equipment expose the operator to vibrations that can cause the *White Finger Syndrome (Syndrome of Raynaud)*. This could reduce the sensitivity of the hands in distinguishing different temperatures and cause a general numbness. The operator should therefore check the conditions of the hands and fingers if the machine is used continuously or regularly. If one of the symptoms should appear, consult a doctor immediately.
- Prolonged use of the machine or other equipment can cause discomfort, stress, fatigue, hearing damage. Wear suitable hearing protection when using the machine. Correct and scrupulous maintenance can also help to protect you further from the risk of noise and vibration.
- Never start or run the engine in a closed or poorly ventilated place.



CAUTION! The exhaust fumes are toxic if inhaled, and may cause asphyxiation and even death.

Work zone

- Examine the work area and be careful of any hazards (such as roads, driveways, power lines, hanging tree limbs, etc.).

- Before use, remove any rubbish from the work area such as rocks, broken glass, ropes, metal parts, cans, bottles and any foreign body that could become entangled with rotating parts or be projected dangerously at a distance. Contact between the blades and any extraneous objects could cause serious injury to the operator or other people or animals in the vicinity, and could also damage the machine.
- **B3.** Cut only the material recommended for each accessory and take care not to let the blades come into contact with rocks, metal parts, etc.
- Take special care when working on sloping terrain.
- **B4.** Keep any other persons or animals away from the work zone (minimum distance 15 meters). Since there is a danger when you are working that the blade or nylon string head could throw out grass, dirt, rocks or foreign bodies, when someone approaches switch the engine off or stop the blade or rotating head (see section entitled "*Starting and stopping the engine*").
- Take account of possible hazards that may not be perceived because of the noise of the machine.
- Make sure there is someone in the vicinity within safe calling distance in case of accident.

During use

- **B5.** Fasten your hair above shoulder length.
- **B6.** Use the machine holding it to the right of your body so that the exhaust fumes can escape freely without obstruction from your clothing. If you have never used a brush cutter before, practice using it for a while before actually starting to work with it
- **B6.** While working, grip the brush cutter firmly with both hands. Stand in a stable position on your feet.
- Keep the grips clean and dry.
- Before starting to work, make sure you are wearing the harness correctly. Adjust the buckle so that the brush cutter is well balanced on your right side with the blade or nylon string head parallel to the ground, from 0 to 30 cm above it.
- **B7.** harness ring (**B**) should be kept in the original position so as not to unbalance the machine.
- Never try to use the machine with any of its parts missing or defective, or after any alterations have been made to it by persons other than authorized service personnel.
- The operator or user is liable for any accidents or damages to third parties and property, and for the dangers to which they may be exposed.
- Do not use the brush cutter while standing on a ladder or other unstable support. You should always be able to control your balance.
- Do not use the machine under extreme weather conditions such as very low temperatures or in a very hot, damp climate.
- Avoid working in bad weather (fog, rain, wind, etc.).
- The blade is sharp, so be very careful when handling it even with the engine off. Wear work gloves. Switch the engine off and wait for all rotating parts to come to a complete stop before performing any operation on the machine or touching the blade or nylon string head,

especially if you have to remove any material entangled with those parts.

- Keep all parts of your body and clothing away from the blades during startup or when the engine is running.
- During use, keep the work zone in front of you. Never cut walking backwards as you cannot see possible hazards.
- Do not put the machine down with the engine running. Never leave the machine alone.
- Never leave the machine with the engine running.



CAUTION! In order to ensure proper operation and safe use of the machine, make sure to use original replacements at all times.

Precautions for carrying the machine

- **B8.** Never carry the brush cutter, even for short distances, with the engine running. Switch off the engine and carry it with the blade or nylon string head facing backward.
- **B8.** When you transport the brush cutter in a motor vehicle, place it in a stable fixed position so that no fuel leaks out. We recommend emptying the fuel tank whenever you transport the machine.



CAUTION! For your safety, during transport and storage, always protect the blade with the guard supplied with the machine.

Fire prevention precautions

- **B9.** Never work with the brush cutter in the presence of fire or spilled gasoline.
- **B9.** When filling the fuel tank, dry any spilled fuel. Do not smoke during this operation. Start the engine at a distance from the filling site and far away from any fuel tanks (at least 3 meters). Do not fill the tank with the engine running.
- Keep the machine clean by removing any grass cuttings, leaves, excess oil to reduce the fire hazard.

Precautions for operating a split shaft machine

- **B10.** If your machine is a split shaft model, that is to say composed of a power unit (1) and an attachment (2), you must furthermore conform to the following rules: Never turn on the machine without an attachment correctly fitted. Before every start check the attachment/shaft joint and the attachment to be assembled correctly and in excellent conditions. This manual is meant to be: the manual of the power unit; the manual of the string head/grass blade attachment and, moreover, if not explicitly stated otherwise, it refers to the two units as already assembled in their proper way (see *chapter F6. attachments fitting/removal*)
When using other attachments, carefully read their instruction manual and make sure you understand them before using. This machines allows the fitting of the following attachments only: UNIVERSAL OUTDOOR ACCESSORIES - Hedge Cutter Attachment.

Kickback

Machines equipped with blades may produce a violent kickback on contact with solid bodies. The blade is capable of amputating arms and legs. The force of the kickback can cause the operator to lose control of the machine.

Kickback can also occur when cutting with any type of blade in the hazardous zone (see **N1**); we therefore recommend cutting using the remaining zone.

-  **CAUTION!** Always use a sharp blade. A blade with worn teeth can create problems in cutting and cause the blade to kickback.

C. Description of the safety devices on the machine, controls to be made and maintenance of the safety devices

-  **CAUTION!** Do not use the machine for any reason with its safety devices out of order.

This section describes the safety devices on the machine, and provides instructions for control and maintenance to keep them in perfect working order. The section "*General Description*" will help you to identify the parts described in this section. The risk of accidents increases considerably if maintenance is not performed regularly or is not done professionally. In case of any doubts contact an authorized service center.

Safety lever

-  **CAUTION!** Never use the machine with its Safety lever pressed with adhesive tape, string or other.
- This device serves to prevent accidentally pressing the throttle trigger (fig. **A no. 3**). In fact, the trigger (fig. **A no. 3**), can only be pressed if the safety lever is pressed at the same time (fig. **A no. 20**).
- By means of 2 separate springs, upon releasing the grip, the throttle trigger (fig. **A no. 3**) and safety lever (fig. **A no. 20**) return automatically to their original positions.

Engine stop device

- Turn the stop button Stop (fig. **A no. 8**) to O / STOP to stop the engine.
- To make sure this button works properly, start the engine and check that it stops when the Stop button (fig. **A no. 8**) is turned to the Stop position.

Protection for transport

-  **CAUTION!** Before applying the guard switch off the engine and wait for the cutting device to stop. Use the blade guard whenever you have to transport and store the machine.

The guard covers the sharp extremities of the blade when the machine is in the resting position for transport or storage (fig. **A no. 24**).

-  **CAUTION!** Never use the machine for any reason without the specific safety devices listed below! Though they do not entirely eliminate all risks, they greatly reduce the danger.

-  **CAUTION!** Do not sharpen a damaged or worn blade. Replace it with a new one.

-  **CAUTION!** We recommend the use of original accessories and replacements, which can be purchased from authorized distributors. The use of other accessories and replacements increases the danger of accidents and in this case the manufacturer has no liability for damages to persons and/or property.

Safety guard

-  **CAUTION!** Never use the machine for any reason without the recommended safety guard for the cutting device in use. The use of an inadequate or defective guard can cause serious injuries. Periodically, check its conditions and replace if necessary.

- This very important safety device (fig. **A no. 19**) prevents any objects that come into contact with the cutting device, or the grass itself, from flying up and striking the operator. It should be checked regularly; check the assembly and make sure the fastening screws are tight (see "*Assembly of safety guard*").
- If you strike any hard objects that cause structural damage to the guard on the cutting device, take the machine to an authorized service center for replacement of the guard.

Safety pole guard

-  **CAUTION!** Never use a brush cutter without its safety pole guard correctly in place.

This device, fastened to the machine, ensures a minimum distance between the operator and the cutting device during use, and prevents the machine from striking and injuring the operator if the blade hits a hard surface (fig. **A no. 21**).

Muffler

- The muffler serves to reduce the noise level to a minimum and to route the exhaust fumes produced by the combustion engine away from the operator.
- Follow these procedures for safe use of the brush cutter.

-  **CAUTION!** The muffler can get very hot during use and should be allowed to cool for some time after switching off the engine. Therefore, take special precautions when, for any reason, you have to touch the area around the muffler.

-  **CAUTION!** Fire hazard. Never use the machine with a defective or damaged muffler.

 **CAUTION!** Engine exhaust fumes are toxic. For this reason, you should not use the machine indoors.

 **CAUTION!** Engine exhaust fumes can get very hot and may contain sparks. Do not use the machine near inflammable material.

Harness

 **CAUTION!** It is very important to familiarize yourself with the release mechanism. In case of emergency you need to be able to release the machine quickly.

The harness is equipped with a fasten-release mechanism. The harness enables the operator to support the machine during use (see "Safety precautions", B7). Before fastening the machine to the strapping, adjust the bandolier belt so that the fasten/release device is about 15 cm above your waist. Using the blade, fasten the machine to the buckle using the hole nearest your body.

D. Fuel Mixture

-  **CAUTION!**
- Do not smoke while refueling!
 - Open the cap on the tank by loosening it slowly.
 - Fill the tank outdoor, far from flames or sparks.
 - Never add fuel in the tank when the engine is running or hot to avoid the risk of fire (let the engine cool off before filling the tank).
 - Avoid contact of the oil and fuel with the skin and eyes.
 - Fill the tank in a well-ventilated place.
 - Do not inhale the toxic fumes of the fuel mixture.
 - Store the fuel mixture in suitable fuel containers only.

Preparation of the mixture

 **CAUTION!** Do not use any other type of fuel than the type recommended in this manual. This machine is equipped with a two-stroke engine and should therefore be fueled with a mixture of unleaded gasoline (with a minimum octane rating = 90) and fully synthetic oil specific for two-speed engines that use unleaded gasoline in the proportions indicated in the table on the cover, fig. (D).

 **CAUTION!** Control the specifications of the oil shown on the package; the use of oil lacking the specifications expressly indicated in this manual could cause serious damage to the engine!

- To obtain the best mixture, pour the oil into an approved container first, followed by the gasoline, and shake the container well (every time you take fuel out of it).
- Be careful not to spill the gasoline.
- The characteristics of the mixture tend to deteriorate in time, so you should only prepare as much mixture as you are going to need (the use of deteriorated fuel can seriously damage the engine).

Filling the tank

-  **CAUTION!** The following precautions should be taken to reduce the fire hazard:
- Always ensure there is adequate ventilation.
 - Do not smoke or take sources of heat or sparks near the fuel.
 - Refuel with the engine off.
 - Open the cap on the tank carefully to eliminate any excess pressure.
 - Do not take the cap off the tank with the engine running.
 - After fueling, close the cap tightly.
- Fill the tank in a well-ventilated place.
 - Place the machine on a solid flat surface so that it cannot tip over, with the cap on the tank facing upward.
 - Clean the area around the fuel cap before removing it, to prevent any impurities from contaminating the fuel.
 - Take the cap off the fuel container carefully. Unscrew the cap on the fuel tank and fill it with the necessary quality, using a funnel.
 - Take care not to spill any fuel.
 - After filling the tank, screw the cap on tightly.
 - During use, to prevent problems in starting the engine again, we strongly recommend that you avoid letting the fuel run out in the tank.

 **CAUTION!** If you spill any fuel, wipe it off the machine. If you have spilt it on yourself, change your clothes at once. Avoid contact with the skin or eyes.

 **CAUTION!** The muffler gets very hot during use and remains hot for some time after switching off the engine. This also applies at idle speed. Take every precaution to reduce the fire hazard, especially in the presence of inflammable materials or gas.

Fuel storage

- Gasoline is highly inflammable.
- Before going near any type of fuel, put out your cigarette, pipe or cigar.
- Store the fuel in a cool, well-ventilated place, in an approved fuel storage container.
- Never store the engine with fuel in the tank in a poorly ventilated place where the fumes produced by the

gasoline could propagate and reach a fire, candle, burner or furnace pilot light, water heater, dryer, etc.

- The fumes produced by the fuel can cause an explosion or fire.
- Never store excessive quantities of fuel.

E. Assembly of safety guard

E1,E2. Assembly of safety guard

Fit the safety guard (A) against the gearbox (I) position the lower clamp (G) in the housing under the shield and the upper clamp (F) over the shaft. Insert and tighten the screws (H).

E1. Safety guard extension (exclusively for use with nylon string head)

- The extension (B) should be installed only for use with the nylon string head, with the aid of the string cutter blade (L), that regulates the length of the string and thus the cutting diameter.

- For correct assembly see the illustration on the cover and perform the following sequence of steps:
- Insert the extension (B) on the safety guard (A) at the reference notches (C), and fasten with the screws (D), then apply the string cutter blade (L) with the cutting edge facing towards the outside of the shield, and fasten it with the screw (E) (Make sure the screws are tightened all the way (E) and are not loosened by the vibrations. If necessary, tighten them again).



CAUTION! If you are using the grass cutting blade, remove the extension (B) on the guard (A).

F. Usable cutting tools and their installation on the machine



CAUTION! The following are the only cutting devices that can be installed on your machine:

a) Nylon string head

b) Grass blade with a maximum of 8 teeth.

Each of these devices requires the installation of a special guard. Follow the instructions for correct assembly carefully. Fasten the cutting tools correctly with all their parts in the order indicated so as to prevent severe injuries to the operators, other people and animals.



CAUTION! Use grass blades or nylon string heads with the MAXIMUM ROTATION SPEED (stenciled on them by the manufacturer) of at least 10.500 min⁻¹.



CAUTION! Any operations involving the cutting devices and their guards should be done with the engine off.



CAUTION! If you turn the machine over to facilitate assembly of the cutting tools, make sure the cap on the fuel tank is securely fastened and there are no leaks of fuel.



CAUTION! WE RECOMMEND THE USE OF ORIGINAL ACCESSORIES AND REPLACEMENTS, WHICH CAN BE PURCHASED FROM AUTHORIZED DISTRIBUTORS. THE USE OF OTHER ACCESSORIES AND REPLACEMENTS INCREASES THE DANGER OF ACCIDENTS AND IN THIS CASE THE MANUFACTURER HAS NO LIABILITY FOR DAMAGES TO PERSONS AND/OR PROPERTY.

Assembly of nylon string head and blade

Apply the proper guard depending on whether you plan to use the grass blade or nylon string head (see chapter: "Application of protective devices on cutter").

- F1. Apply the nylon string head as shown in the illustration: a) Protection flange b) Upper plate c) Guard

d) Nylon string head. Tighten by turning counterclockwise.

- F2. As you tighten, hold the nylon string head and plate still and insert the wrench or screwdriver supplied in the holes in the plate and gearbox; first turn the plate until the two holes match.
- F3. Apply the blade as shown in the illustration: a) Protection flange b) Upper plate with blade centering c) Guard d) Blade with wording and direction arrow facing upward e) Lower plate f) Fixed cup g) Blade fastening nut.



F3. CAUTION! Do not use the nylon string head guard extension (H) with metal blades.

- F4. Make sure the hole in the blade is perfectly coupled with the centering collar on the upper plate. Tighten by turning counterclockwise. As you tighten, hold the blade-plate assembly still by inserting the wrench or screwdriver supplied in the holes provided.

F5. "Tap and go" nylon string head

The nylon string head is used to cut grass and weeds along borders or in zones with obstacles like walls, fences or trees. It can operate in a very narrow or uneven zone. The nylon string cuts the grass neatly without damaging the bark of the trees or causing violent impact such as due to the contact of a rigid blade with a hard surface.

F6. attachments fitting/removal (for split shaft models only)

- 1) Loosen the joint knob first, then insert attachment's shaft into the shaft/attachment joint (1) and make sure that the locking pin(A) is secured in one of its housings, finally lock firmly the joint knob(B).
- 2) To remove the attachment from the power unit: loosen the joint knob(1), push the locking pin (2) and, keeping it pressed, remove attachment's shaft from the joint(3).
- 3) Every attachment manual explains through a picture in which ways each attachment can be assembled on the power unit: a configuration is forbidden if crossed ,if marked with "NO" and/or the ✘ symbol,

or if it isn't shown at all. A configuration is allowed if marked with "OK" and/or the ✓ symbol. The figure shows assembling configurations allowed for the string head/grass blade attachment (with the rules defined in the previous paragraph, it is forbidden to assemble the string head/grass blade attachment with the locking pin in both left and right housings, allowing its assembling in the upper housing only).

Supply of the nylon string

 **CAUTION!** The string cutting blade housed in the plastic shield will cut the nylon string to optimum length; a string that is too long

reduces the rotation speed of the engine and interferes with cutting efficiency, as well as increasing the risk of injury.

During cutting, the nylon string wears naturally causing an increase in the speed of the engine and a reduced cutting capacity. When this happens, to bring out more string bump the head against the ground: release the throttle trigger to reduce the engine speed to less than 4000 rpm. Tap gently on the ground with the button (A) as shown in the figure and the string will come out automatically. Accelerate again. If the string does not come out make sure there is still some left and try again.

G. Assembly of grips

G1. Double handled grip

The grip (A) can be adjusted to suit the needs of the operator by moving it forward or backward. Loosen the knob (C), place the handle in the desired position then tighten the knob (C) again.

 **CAUTION!** The handle assembly (A) can be folded parallel to the transmission shaft to facilitate transport and storage of the machine. Loosen the knob (C), turn the support (B), by 90° clockwise, fold the handle (A) in the desired position and tighten the knob (C).

G2. Delta handle

For your safety, fasten the delta handle in front of the label placed on the shaft at a distance of at least 18 cm from the rear grip. The handle should be fastened in a comfortable working position. The safety pole guard should be mounted using the accessories supplied and in the configuration shown in the figure, in contact with the delta handle.

Bent front grip

 **CAUTION!** The grip acts as a guard when the special extension is mounted (D). Screw the side safety guard securely into the threaded housing on the bent grip as shown in the figure, whenever you use the cutting blade.

The bent grip (A) can be adjusted according to the needs of the operator by folding it forward or backward. Press the grip adjustment knob (B), place the grip in one of the positions marked with the notches (C) in a convenient working position and release the knob (B).

 **CAUTION!** With the blade installed, use the machine with the grip adjusted in the position marked with the first notch only.

 **CAUTION!** Fold the grip parallel to the machine - in the position of the last notch (C) - to facilitate transport and storage of the machine.

H. Starting and stopping the engine

 **CAUTION!** First read chapter "Safety Precautions"

 **CAUTION!** Start the brush cutter in a flat place. During startup stand in a stable position. Make sure the blade or nylon string head do not touch the ground or any obstacles.

 **CAUTION!** Grip the knob of the starter with one hand and hold the machine in a stable position with the other. (Take care not to wind the starter string around your hand) and pull slowly until you encounter some resistance, then pull the cord sharply and forcefully (to start the engine when cold or warm follow the procedures described).

 **CAUTION!** Do not pull the starter cord all the way and do not release it abruptly against the machine as this could damage it.

Startup of cold engine

- **H1.** Stop switch (A) turned to I opposite the "STOP" mark.
- **H2.** Turn the fuel enrichment lever (B) to the closed position.
- **H3.** Pump by pressing several times on the bulb (C) until you see the fuel flow back into the tank through the tube (D). Pull the starter cord until the machine starts.

Let the engine run a few seconds holding the brush cutter still. Grasp the control grip firmly and accelerate, automatically the enrichment lever will return to its original position.

 **CAUTION!** The cutting devices are now rotating.

Startup of warm engine

- **H1.** STOP switch turned to I (START). Throttle trigger lever in minimum position (released).
- **H4.** Enrichment lever (B) in original position.

- **H3.** Pump by pressing several times on the bulb (C) until you see the fuel flow back into the tank through the tube (D). Pull the starter cord.

Stopping the engine

- **H5.** Turn the stop switch (A) to O (STOP).

 **CAUTION!** After stopping the engine the rotating parts, blade or nylon string head, keep spinning by inertia for a few seconds. Grip the machine firmly until they stop.

 **CAUTION!** In case of emergency the above delay can be abbreviated by scraping the blade supporting cup parallel on the ground.

I. Carburetor adjustment

Your machine can be equipped with a low emission carburetor. We recommend that you have any adjustment of the carburetor made exclusively by an authorized service center, which disposes of special equipment for ensuring the best performance with the lowest emissions. To adjust the speed to the minimum, turn the screw marked (T) as shown: With the engine running and well warmed up, turn the screw (T) gently clockwise, until the engine rotates at regular speed (stead noise), without the cutting devices in motion. If the cutting devices are moving, turn the screw (T) gently counterclockwise until you obtain the proper adjustment. The correct minimum speed is

shown in the instruction manual in the paragraph of technical data.

 **CAUTION!** All the above adjustments should be made with the cutting devices correctly installed.

 **CAUTION!** Start the brush cutter in a flat place. During startup stand in a stable position. Make sure the blade or nylon string head do not touch the ground or any obstacles.

The warranty may be invalidated due to erroneous adjustments made by personnel not belonging to authorized service centers.

L. Routine maintenance

Check periodically to see that all the screws in the machine are securely fastened in place. Replace damaged, worn, cracked or bent blades. Always make sure the blade or nylon string head is correctly installed and the nut holding the blade is tight.

L1. Cleaning the air filter

(At least every 25 hours of work). A clogged filter causes alteration of the carburetor adjustment, reducing power and increasing fuel consumption, as well as causing difficulties in startup. Open the cover on the filter as shown in the figure by pressing in the point indicated by the arrow for release. Clean the inside of the filter housing thoroughly (fig. L2). The filter can be cleaned using gentle jets of compressed air. For more thorough cleaning it can be washed in soapy water.

L3. Gearbox

Every 50 working hours add grease for high speed gears in the gearbox, through the hole (C).

L4. Spark plug

Periodically (at least every 50 hours) remove and clean the spark plug and set the space between the electrodes (0.5/0.6 mm). Replace it if excessively encrusted or, in any case, after 100 working hours. In case of excessive encrustation check

the carburetor adjustment, the percentage of oil in the fuel mixture and make sure the oil is of excellent quality and suitable for two-stroke engines.

L5. Fuel filter

To clean or replace the filter, remove the cap on the tank and take the filter out using a hook or long-nose pliers. Periodically, every season, contact your service center for general maintenance and cleaning of the inside. This will reduce the possibility of unexpected problems and will ensure the good performance and long life of your machine.

 **CAUTION!** Regularly it is important, in order to prevent the engine from overheating, to remove the dust and dirt from the vents, the cylinder cover and fins on the cylinder, using a wooden scraper.

 **CAUTION!** In case of prolonged disuse, empty the fuel tank and run the engine until it is out of gas. Store the brush cutter in a dry place.

L6. Attachments maintenance (for split shaft models only)

Follow maintenance instructions on the attachment manual.

M. Replacement of nylon string

 **CAUTION!** Use only the recommended type of nylon string. Do not use steel wires for any reason, in order to prevent serious injury.

String replacement

If, when you bump the nylon string head on the ground, no more string comes out, it means there is none left and you have to replace it. To replace the

reel of string, press both the release pawls indicated by the arrows, remove the empty reel, unroll any string left and rewind the new string. Open the original package of string and insert the ends of the two strings in the eyelets on the reel, then wind the strings completely on the reel in the same direction and fasten the end of each string in the 2 opposite grooves. Replace the reel in its housing and thread the ends of the strings in their bushings. Pull each string so that about 15 cm comes out on each side. Reassemble the nylon string head as shown. If the reel becomes exces-

sively worn, replace it with a whole new reel.

Replacement of entire string reel

If the reel becomes excessively worn, replace it with a whole new reel.

Replacement of the complete nylon string head

If upon visual inspection (and in any case after a violent bump) the casing on the nylon string head appears damaged, it should be replaced. For this operation see *"Usable cutting tools and their installation on the machine"*.

N. Cutting techniques



CAUTION! Before using the machine read the following chapters carefully: "Safety Precautions" and "Description of safety devices".



CAUTION! Always wear the recommended personal protection gear.



CAUTION! Before using the machine, make sure all the parts are properly assembled.



CAUTION! In mounting the cutting utensils follow the instructions in the chapter entitled "Usable cutting tools and their installation on the machine". **ABSOLUTELY DO NOT USE THE BRUSH CUTTER IF THE SPECIFIC SAFETY GUARD FOR THE CUTTING DEVICE IN USE IS NOT SECURELY FASTENED** (see chapter "Assembly of safety guards"). Failure to follow this rule can expose you to serious danger such as:

- possible contact with rotating and cutting parts
- possible contact with flying debris.



CAUTION! Do not use worn or damaged cutting devices.



CAUTION! Try to limit contact and impact of the cutting devices against the ground and other objects as much as possible. Hold the cutting device away from your body.



CAUTION! Twigs or grass may jam between the safety guard and the blade or nylon string head. Never try to remove this material with the engine running and the blade rotating. Always stop the engine before performing any operations of cleaning, and wait for the cutting device to stop in order to prevent injury.



CAUTION! During use and for a few minutes after switching off the machine, the gearbox and zone near the shaft on which the cutting device is fastened are very hot. Contact can cause burns. Do not touch these parts if they are still hot.



CAUTION! The muffler and its guard are very hot during use and after the engine has been switched off, even with the engine running at

minimum speed. Contact can cause burns. Do not touch these parts if they are still hot.

The machine is ideal to complete the work of the lawnmower. In fact, it can reach places where a normal lawnmower is unable to go. During the cutting operations, keep the engine running at high speed. After every cutting stage, decelerate the engine to minimum speed as running it at top speed without a load can damage the engine severely. Never raise the brush cutter above knee level during cutting. Wait until the engine is running at minimum speed before moving the machine from one section to another. Stop the engine when you change workplace. Before you start cutting again, make sure your position is correct and stable. Cutting and trimming grass borders with the nylon string head



CAUTION! For nylon string heads, use only strings made of flexible material recommended by the manufacturer. For example, you should never use metal wire because it could cause serious injuries to people, property and animals. An unsuitable string could break and turn into a very dangerous missile.

Cutting with the nylon string head is suitable for light jobs like trimming borders and cutting the grass around trees.

Mowing

To prevent damage to your lawn or the cutting mechanism, keep the string parallel to the ground but avoid contact with the terrain.

Trimming borders

Angle the nylon string head keeping it a short distance from the ground. Cut using the end of the string. Do not press the string against the material to be cut.

Drawing out the string

As you cut, the nylon string wears down naturally. When this happens, to draw out more string bump the head against the ground (see paragraph entitled "Tap and go system for nylon string head").

Thinning grass with the grass cutter blade



CAUTION! Always work with a sharp blade. A blade with worn teeth can create problems in cutting and can cause KICKBACK, that is, a violent thrust on the front of the machine caused by the impact of the blade against wood or solid foreign bodies. This kickback can cause loss of control of the machine. Never sharpen a damaged blade: replace with a new one.



N1. CAUTION! Do not let the blade cut in the risk sector to prevent kickback (see paragraph "Safety precautions").

Cutting with the blade is recommended for thinning the grass, especially when tall and sturdy.

N2. The grass is cut with swinging motions from side to side, maintaining the blade parallel to the ground. During

the right to left swing the grass is cut, while the backswing must be made without using the blade. KICKBACK can occur when cutting is done with the risk sector of the blade; we recommend cutting with the rest of the blade. Take care that the cup supporting the blade just grazes the ground. This will prevent the blade from touching the ground.



N1. CAUTION! WE RECOMMEND THE USE OF ORIGINAL ACCESSORIES AND REPLACEMENTS; THESE CAN BE FOUND AT YOUR OFFICIAL DISTRIBUTOR'S. THE USE OF ACCESSORIES AND REPLACEMENTS THAT ARE NOT ORIGINAL INCREASES THE DANGER OF ACCIDENTS AND IN THIS CASE THE MANUFACTURER IS NOT LIABLE FOR ANY DAMAGES TO PERSONS OR PROPERTY.

O. Environmental information

This section contains information useful for maintaining the characteristics of eco-compatibility included in the origin design of the machine, and as regards proper use and disposal of oil and fuel.

Design

In the design stage, care was taken to develop an engine with reduced consumption and low emissions of noise and pollutant exhaust fumes.

Use of machine

The operations of filling the tank with the fuel mixture should be carried out in such a way as to avoid spilling fuel and contaminating the soil and environment.

Periods of prolonged disuse

Always empty the fuel tank with the same precautions used in filling it (O).

Disposal

Do not dispose inappropriately of the machine when it is no longer usable. Deliver it to an authorized organization for proper disposal in compliance with the regulations in force.

P. Troubleshooting table

	The engine does not start	The engine stutters or loses power	The machine starts but does not cut properly
Make sure the STOP switch is on I.	●		
Make sure that the fuel tank is at least 25% full.	●	●	
Make sure the air filter is clean.	●	●	
Remove the sparkplug, dry and clean it, then return it to its place. If necessary, replace it.	●	●	
Change the fuel filter. Contact your supplier.		●	
Follow the correct procedure for assembly of the cutting accessories.			●
Make sure the metal accessories are sharp, and contact your supplier if necessary.			●

The engine continues to have problems: contact your authorized supplier

Q. Declaration of conformity

The undersigned, authorized by Husqvarna Outdoor Products Italia SpA, declares that the following products model /TYPE: **BC020, BC021, BC022** starting from the serial numbers produced from 2006 on, manufactured by Husqvarna Outdoor Products Italia SpA, Valmadrera, Italia, comply with European Directive: 98/37/EEC (Machine Directive), 93/68/EEC (EEC Marking Directive) & 89/336/EEC (Electromagnetic Compatibility Directive), directive 2000/14/EEC (Enclosure V).



Valmadrera, 15.10.06
Giuseppe Todero (Technical Manager)
Husqvarna Outdoor Products Italia SpA
Via Como 72, 23868 Valmadrera (Lecco)
ITALY

R. Technical data

Displacement (cm ³)	30	30	30
Bore (mm)	38	38	38
Stroke (mm)	26	26	26
Engine output (kW) (ISO 8893)	0.8	0.8	0.8
Maximum shaft rotation frequency (min ⁻¹)	7700	7700	7700
Rotation speed (frequency of rotation) of engine at maximum rotation frequency recommended for shaft (min ⁻¹)	10780	10780	10780
Engine speed at max power (min ⁻¹)	8500	8500	8500
Minimum speed (min ⁻¹)	2800	2800	2800
Maximum speed, no load (min ⁻¹)	10500	10500	10500
Dry weight (kg)	5.4	5.4	5.4
Fuel tank capacity (cm ³)	400	400	400
Noise pressure (at operator ear) L _{pav} (dBA) (ISO 7917)	99	99	99
Measured sound power level L _{Wav} (dBA) (ISO 10884)	113	113	113
Guaranteed noise level L _{Wav} (dBA) (ISO 10884)	114	114	114
Vibrations of rear/right grip (m/s ²) (ISO 5349)	4.3-15	2.3-14.2	3.6-15
Vibrations of front/left grip (m/s ²) (ISO 5349)	7-15	5.3-12.4	4.2-12
	Delta grip 30cc	"Ergo" grip	Double handled grip