

Operator's Manual	READ CAREFULLY		GB
Manuale d'istruzioni	LEGGERE ATTENTAMENTE		I
Manuel d'instructions	LIRE ATTENTIVEMENT		F
Bedienungsanleitung	SORGFÄLTIG LESEN		D
Manual de instrucciones	LEER ATENTAMENTE		E
Gebruikershandleiding	EERST GOED DOORLEZEN		NL
Ägarhandbok	LÄS NOGA		S
Brughåndbog	LÆS OMHYGGELIGT		DK
Omistajankäsikirja	LUE HUOLELLISESTI		FIN
Eierens Håndbok	LES NØYE		N
Manual de Instruções	LER ATENTAMENTE		P
ΟΔΗΓΙΕΣ ΧΡΗΣΕΩΣ	ΔΙΑΒΑΣΤΕ ΠΡΟΣΕΚΤΙΚΑ		GR
Használati útmutató	FIGYELEMMEL OLVASANDÓ		H

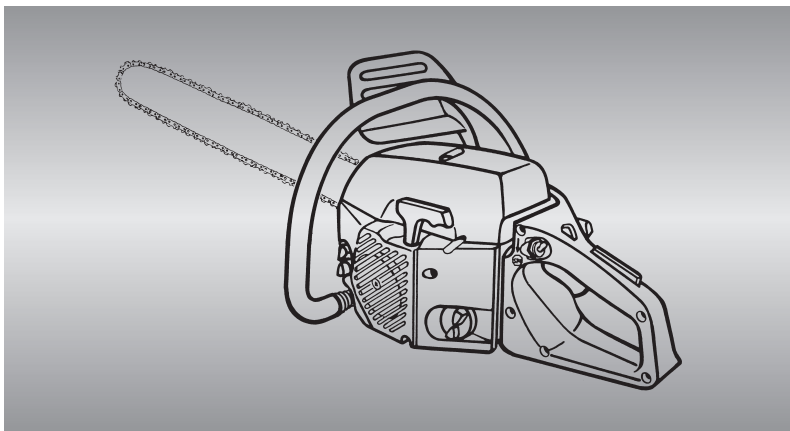

Mac 538E - 38 cc
Mac 540E / California / Promac 40 II - 40 cc
Mac 545E / Promac 46 II - 46 cc

A.

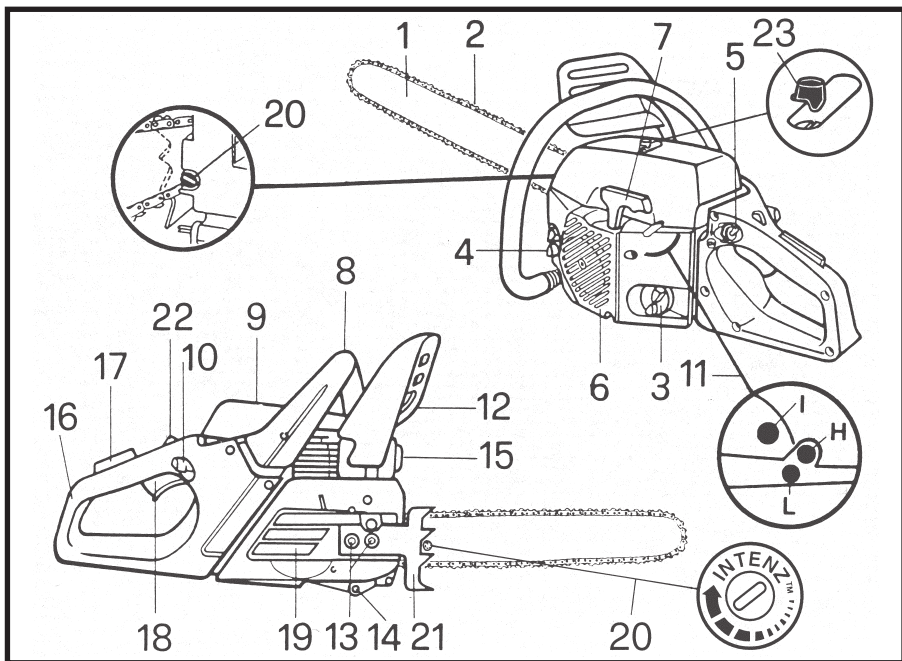

B.

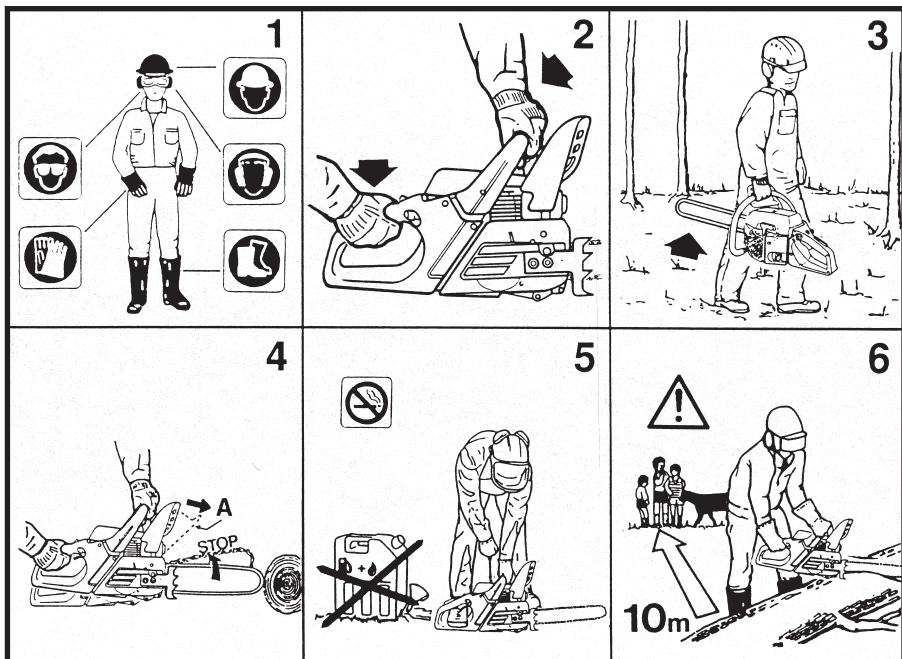

C.

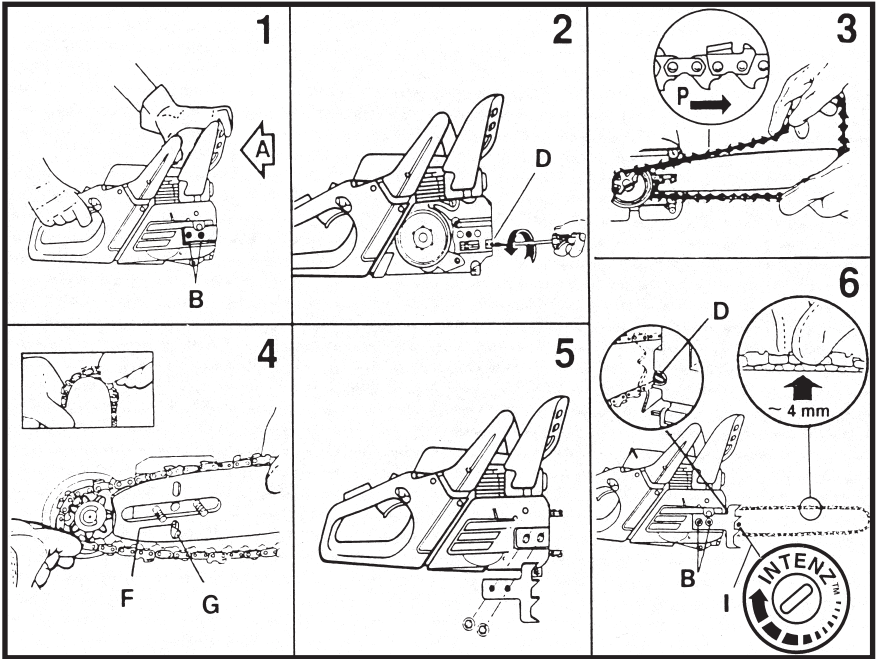

D.

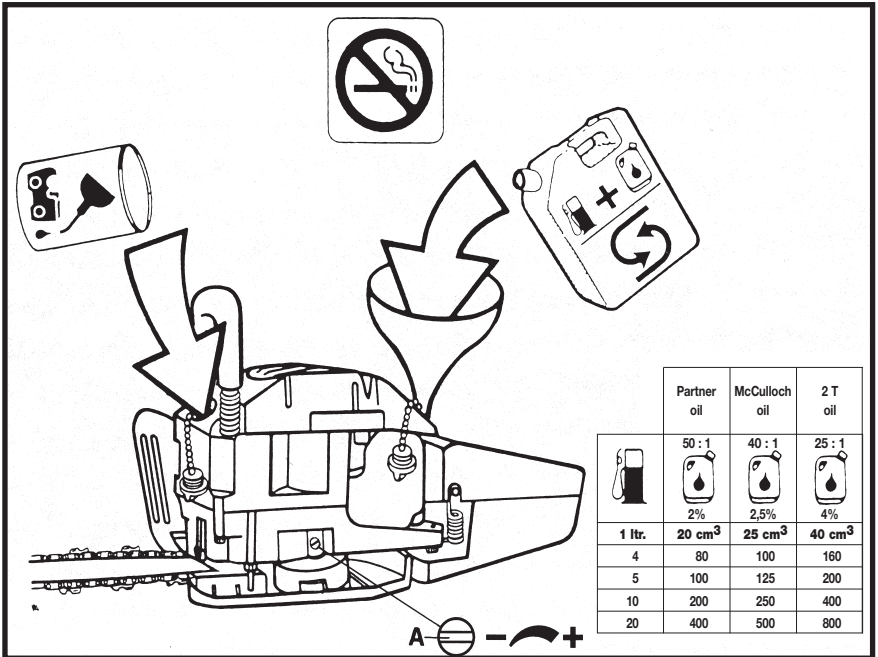

E.

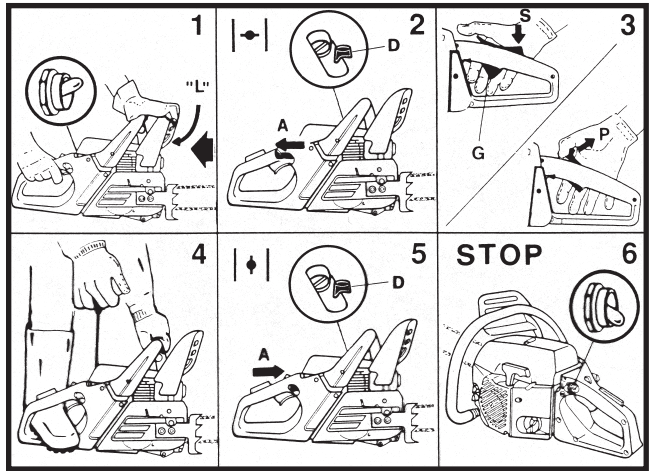

F.

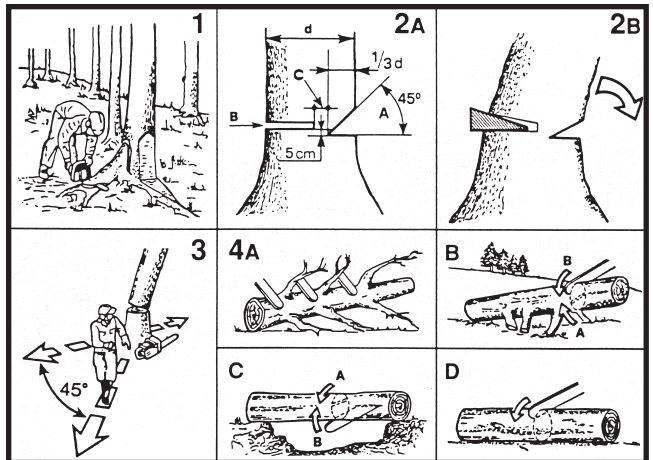

G.

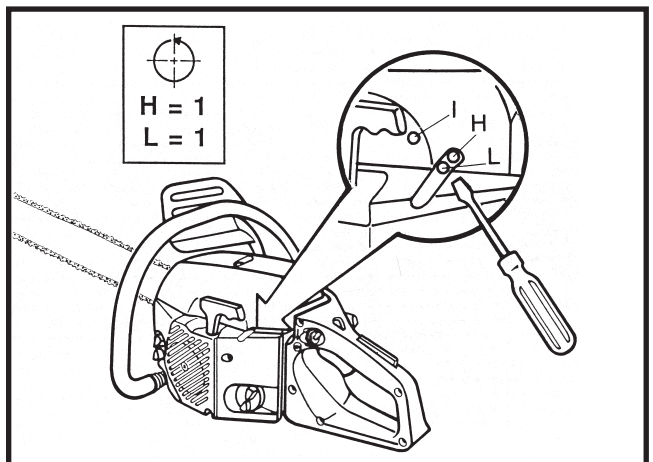

H.

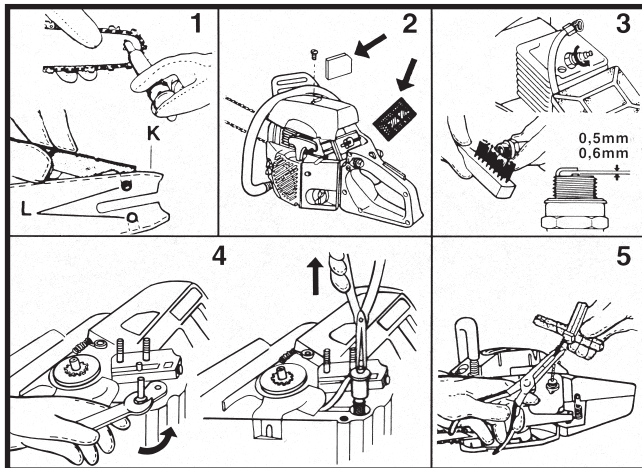



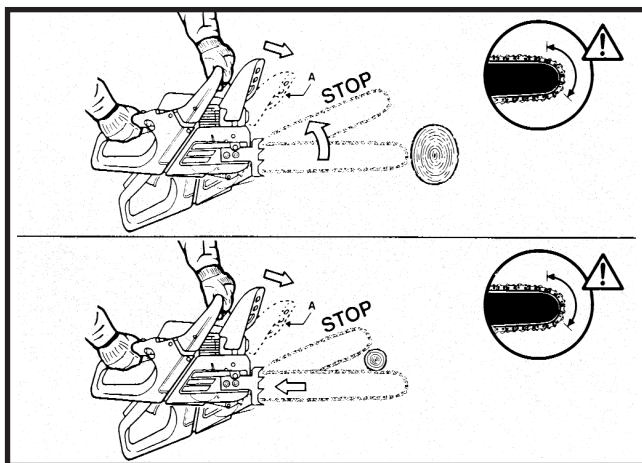



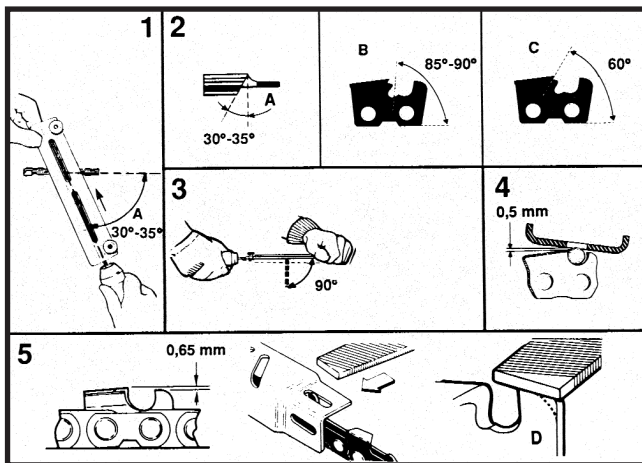

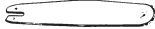



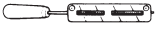

I.



L.



	MAC 538E	MAC 540E - 545E California	Promac 40 II Promac 46 II
14" 350mm  50T  3/8" 	214235B 202631B 214215B (5/32")		
16" 400mm  55T  3/8" 	214236B 202729B 214215B (5/32")	241997B 202729B 214215B (5/32")	
18" 450mm  60T  3/8" 	229157B 228546B 214215B (5/32")	241996B 228546B 214215B (5/32")	
16" 400mm  66T  3/8" 			323219B 247003B 214216B (3/16")
18" 450mm  72T  3/8" 			323215B 228548B 214216B (3/16")

- GB** Due to a constant product improvement programme, the factory reserves the right to modify technical details mentioned in this manual without prior notice.
- I** La casa produttrice si riserva la possibilità di variare caratteristiche e dati del presente manuale in qualunque momento e senza preavviso.
- F** La Maison se réserve la possibilité de changer des caractéristiques et des données de ce manuel à n'importe quel moment et sans préavis.
- D** Im Sinne des Fortschritts behält sich der Hersteller das Recht vor, technische Änderungen ohne vorherigen Hinweis durchzuführen.
- E** La firma productora se reserva la posibilidad de cambiar las características y datos del presente manual en cualquier momento y sin previo aviso.
- NL** Door konstante produkt ontwikkeling behoudt de fabrikant zich het recht voor om technische specificaties zoals vermeld in deze handleiding te veranderen zonder hiervan vooraf bericht te geven.
- S** Tilverkaren reserverar sig rätten att ändra fakta och uppgifter ur handboken utan förvarning.
- DK** Producenten forbeholder sig ret til ændringer, hvad angår karakteristika og data i nærværende instruktion, når som helst og uden varsel.
- FIN** Jatkuvan tuotteen parannusohjelman tähden valmistaja pidättää oikeuden vaihtaa ilman ennakkovaroitusta tässä ohjekirjasessa mainittuja teknisiä yksityiskohtia.
- N** Produsenten forbeholder seg all rett og mulighet til å forandre tekniske detaljer i denne manualen uten forhåndsvarsel.
- P** A casa productora se reserva a possibilidade de variar características e dados do presente manual em qualquer momento e sem aviso prévio.
- GR** Λόγω προγράμματος συνεχούς βελτίωσης προϊόντων, το εργοστάσιο επιφυλάσσεται του δικαιώματος να τροποποιεί τις τεχνικές λεπτομέρειες που αναφέρονται στο εγχειρίδιο αυτό χωρίς προηγούμενη ειδοποίηση.
- H** Folyamatos gyártmány felújítási műsorunk következtében, a gyártó cég fenntartja a jogát ebben a Használati leírt műszaki adatok előzetes értesítés nélküli változtatására.

THIS PRODUCT MEETS THE SAFETY STANDARD REQUIREMENT OF THE EUROPEAN MACHINERY DIRECTIVE

DISPLACEMENT (cm ³)	38	40	46
BORE AND STROKE (mm).....	40x30	41x30	43x32
ENGINE OUTPUT (kW).....	1,5	1,75	2,4
ENGINE SPEED AT MAX POWER (min ⁻¹)	8.500	8.500	9.000
MAXIMUM SPEED (min ⁻¹)	11.000	11.000	11.000
MINIMUM SPEED (min ⁻¹)	2.800	2.800	2.800
DRY WEIGHT (Kg) (NO BAR AND CHAIN)	5	5	5,5
CHAIN PITCH (9,525 - 8,255 mm)	3/8"	3/8"-.325"	3/8"-.325"
CHAIN GAUGE (mm).....	1,3	1,3	1,3
BAR LENGTHS (cm).....	35/40/45	40/45	40/45
No. OF SPROCKET TEETH	6	6/7	6/7
OIL TANK CAPACITY (cm ³)	290	290	290
FUEL TANK CAPACITY (cm ³)	390	390	390
SOUND PRESSURE LEVEL (AT THE OPERATOR'S EAR). LpAv (dBA) (EN 27182 - EN 608) ...	97	97	98
GUARANTEED SOUND POWER LEVEL LwAv (dBA) (ISO 9207 - EN 608)	112	112	113
MEASURED SOUND POWER LEVEL LwAv (dBA) (ISO 9207 - EN 608).....	111	111	112
VIBRATION LEVEL (ISO 7505 - EN 608) (m/s ²).....	7,5	8,7	6,9

QUESTO PRODOTTO È CONFORME ALLA DIRETTIVA EUROPEA SULLA SICUREZZA DELLE MACCHINE

CILINDRATA (cm ³)	38	40	46
ALESAGGIO x CORSA (mm)	40x30	41x30	43x32
POTENZA (kW).....	1,5	1,75	2,4
REGIME DI MASSIMA POTENZA (min ⁻¹)	8.500	8.500	9.000
REGIME MASSIMO (min ⁻¹)	11.000	11.000	11.000
REGIME DI MINIMO (min ⁻¹)	2.800	2.800	2.800
PESO A SECCO (Kg) (SENZA BARRA E CATENA)	5	5	5,5
PASSO CATENA (9,525 - 8,255 mm)	3/8"	3/8"-.325"	3/8"-.325"
SPESSORE CATENA (mm).....	1,3	1,3	1,3
LUNGHEZZA BARRA (cm).....	35/40/45	40/45	40/45
No. DENTI DEL PIGNONE	6	6/7	6/7
CAPACITÀ SERBATOIO OLIO (cm ³)	290	290	290
CAPACITÀ SERBATOIO MISCELA (cm ³)	390	390	390
PRESSIONE SONORA ALL'ORECCHIO DELL'OPERATORE LpAv (dBA) (EN 27182 - EN 608).	97	97	98
LIVELLO POTENZA SONORA GARANTITA LwAv (dBA) (ISO 9207 - EN 608)	112	112	113
LIVELLO POTENZA SONORA MISURATA LwAv (dBA) (ISO 9207 - EN 608).....	111	111	112
VIBRAZIONI (ISO 7505 - EN 608) (m/s ²)	7,5	8,7	6,9

CE PRODUIT EST CONFORME À LA NORME EUROPÉENNE POUR LA SÉCURITÉ DES MACHINES

CYLINDRÉE (cm ³).....	38	40	46
ALÉSAGE / COURSE (mm).....	40x30	41x30	43x32
PUISSANCE MOTEUR (kW).....	1,5	1,75	2,4
REGIME MOTEUR PUISSANCE MAX (min ⁻¹).....	8.500	8.500	9.000
REGIME MAXIMUM (min ⁻¹)	11.000	11.000	11.000
REGIME DE RALENTI (min ⁻¹)	2.800	2.800	2.800
POIDS A VIDE (Kg) (SANS BARRE NI CHAÎNE)	5	5	5,5
PAS DE LA CHAÎNE (9,525 - 8,255 mm)	3/8"	3/8"-.325"	3/8"-.325"
JAUGE (mm).....	1,3	1,3	1,3
LONGUEUR DE GUIDE (cm).....	35/40/45	40/45	40/45
NOMBRE DES DENTS DE PIGNONS	6	6/7	6/7
CAPACITÉ DU RÉSERVOIR HUILE (cm ³)	290	290	290
CAPACITÉ DU RÉSERVOIR ESSENCE (cm ³).....	390	390	390
PRESSION SONORE À L'OREILLE DE L'OPERATEUR. LpAv (dBA) (EN 27182 - EN 608).....	97	97	98
NIVEAU DE PUISSANCE SONORE GARANTI LwAv (dBA) (ISO 9207 - EN 608)	112	112	113
NIVEAU DE PUISSANCE SONORE MESURÉ LwAv (dBA) (ISO 9207 - EN 608)	111	111	112
VIBRATIONS (ISO 7505 - EN 608) (m/s ²)	7,5	8,7	6,9

SYMBOL MEANING



Read operator's manual carefully

Wear safety clothing:



1 Approved safety glasses or face shield



2 Approved safety helmet



3 Approved ear defender



4 Approved gloves



5 Approved safety footwear



Do not smoke while refuelling or while operating the machine



Warning - Caution



Choke fully opened (hot start / run)



Choke partially opened



Choke closed (cold start)



Brake engaged / disengaged



Beware of kickback



Do not cut with the end on the bar, this may cause kickback



Never use the machine with only one hand



Always use the machine with both hands

GENERAL DESCRIPTION

A

- 1 - BAR
- 2 - CHAIN
- 3 - FUEL TANK CAP
- 4 - OIL TANK CAP
- 5 - STOP SWITCH
- 6 - STARTER HOUSING
- 7 - STARTER HANDLE
- 8 - FRONT HANDLE
- 9 - AIR FILTER COVER
- 10 - CHOKE KNOB
- 11 - CARBURETOR ADJUSTMENT SCREWS
- 12 - SAFETY CHAIN BRAKE
- 13 - BAR RETAINING NUTS
- 14 - CHAIN CATCHER
- 15 - MUFFLER SHIELD
- 16 - REAR HANDLE
- 17 - THROTTLE TRIGGER LOCKOUT
- 18 - THROTTLE TRIGGER
- 19 - CHAIN BRAKE COVER
- 20 - CHAIN ADJUSTER SCREW / INTENZ
- 21 - SPIKE/SPACER
- 22 - THROTTLE ADVANCE
- 23 - DECOMPRESSION VALVE

SAFETY PRECAUTIONS

B

- 1 All operators should read this manual carefully before using this chainsaw; only use this machine for usage specifically mentioned in this manual.

Wear suitable clothing. This should include snugly-fitting (safety) clothing, sturdy boots, heavy duty gloves, goggles or a face screen and ear plugs or ear muffers. Wear a helmet if there is risk of falling objects or projections from trees.

- 2 Always hold the chainsaw firmly with both hands when the engine is running. Always maintain a firm foothold. Ensure you are able to stop the engine quickly if necessary. Do not work up a tree unless you have received suitable training and have the appropriate equipment (belts, ropes, safety hooks etc.) for this type of work.

We strongly recommend that all first-time chainsaw users obtain practical instruction on safe chainsaw usage before operating the chainsaw.

Do not operate this machine when tired or under the influence of any substances, drugs or alcohol which can impair vision, dexterity or judgement.

Prolonged use of chainsaws or other machines exposing the operator to vibration may produce Whitefinger's Disease (Raynaud's Phenomenon). This may reduce the hands' ability to feel and regulate temperature and may

produce general numbness. Continual or regular users should therefore monitor closely the condition of their hands or fingers. If any of the symptoms appear, seek immediate medical advice.

- 3 Never carry the chainsaw with the engine running. Whenever carrying a chainsaw, even for short distances, the chain should be covered by the chain guard (scabbard) and the bar should point backwards.

When transporting the chainsaw in a vehicle, secure the saw to prevent fuel spillage.

- 4 To avoid kick-back, do not attempt to cut with the nose of the bar. Ensure the engine is running at full throttle before commencing to cut. To avoid kick-back, do not let the nose of the bar come into contact with logs, branches, the ground or any other obstruction. Do not allow any part of the chain to come into contact with rock, nails or wire fence

Ensure the chain is kept sharp and correctly tensioned. Keep the spike or the saw body against the wood when cutting. Use only genuine accessories and spare parts. We recommend you have your unit periodically checked and serviced by an authorised dealer.

Do not use chainsaw above shoulder height.

- 5 Do not operate the chainsaw near a naked flame or spilled fuel. Only operate the chainsaw outside and in well ventilated areas.

After re-fuelling, always wipe off any spilled fuel. Move the chainsaw away from the fuelling point before starting the engine.

- 6 Keep by-standers and animals out of the work area; at a minimum distance of 10 m or twice the timber length. If necessary, use warning signs to keep on-lookers at a distance.

Carefully survey the working site to note any hazards, eg. roads, paths, electricity cables, dangerous trees etc. Do not use the chainsaw if the device for stopping the chain (safety chainbrake) does not work correctly. Never place hands on the chain whilst the engine is running. Ensure someone is within hearing distance in case of an accident. If this is not possible, it is recommended that users operating chainsaws in remote areas carry an adequate first-aid kit with them and ensure someone knows their location. Never leave the engine running while the tool is unattended.

ONLY USE ORIGINAL SPARE PARTS AND ACCESSORIES.

BAR AND CHAIN INSTALLATION - INTENZ G

Ensure engine is always switched off before fitting or adjusting chain. Wear a pair of protective gloves when fitting or adjusting chain.

- 1 Ensure chain brake lever is in disengaged position (A). Remove retaining nuts (B) and cover.
- 2 Turn the adjusting screw (D) counterclockwise taking it fully back.
- 3 Feed chain into bar groove ensuring correct direction of chain (P).

- 4 Work the chain around sprocket and set the bar as illustrated, make the lower hole (F) coincide with the pin (G) of the adjusting screw.

- 5 Reposition side cover. Fit spike as illustrated.

- 6 Lock nuts (B) finger tight.

Adjust chain tension pin by turning screw (D) so that when lifting the chain an entire drive link is just visible.

The chain is correctly tensioned when there is no slack on the underside of the bar, and it runs freely in bar groove. Tighten the bar retaining nuts with the wrench, pushing bar tip upwards.

INTENZ

Turn the adjusting screw (I) counterclockwise taking it fully back.

Feed chain into bar groove ensuring correct direction of chain (P).

Lock nuts (B) finger tight.

Adjust chain tension pin by turning screw (I) so that when lifting the chain an entire drive link is just visible.

The chain is correctly tensioned when there is no slack on the underside of the bar, and it runs freely in bar groove. Tighten the bar retaining nuts with the wrench, pushing bar tip upwards.

FUEL MIX D

Use only fuel recommended by this manual. This product is fitted with a 2-stroke engine and therefore requires a 2-stroke petrol and oil mix. Use leaded (4 Star) or unleaded petrol with a minimum octane rating of 90.

UNLEADED PETROL: if using unleaded petrol, you must use a **totally synthetic** 2-stroke engine oil or branded 2-stroke engine oil (see table).

Only use oil from sealed containers. In order to obtain a good fuel mix, put the oil into the container before the petrol.

IMPORTANT

Always shake this fuel mix vigorously each time you use it. We recommend to carry out this operation each time you use the fuel.

Fuel mix properties deteriorate with time, we therefore recommend that you only make the quantity of fuel mix you will need for each usage. Do not use fuel mix more than a week old as this could damage the engine.

WARNING

Do not smoke when re-fuelling.

Always open the fuel cap slowly.

Re-fuel in open spaces only, keeping away from naked flames or sparks.

Always store fuel in an approved container.

SAFE STORAGE OF FUEL

Petrol is highly inflammable. Put out all cigarettes, pipes and cigars before working with petrol. Avoid spilling petrol. Store fuel in a cool, well ventilated place, in an approved container specifically designed for the purpose.

Never store engine with fuel in the tank in enclosed, poorly ventilated areas, where fuel fumes may reach an open flame, spark or pilot light such as in a furnace, water heater, clothes dryer etc. Petrol fumes can cause an explosion or a fire. Do not store large amounts of fuel.

CHAIN LUBRICATION

IMPORTANT

The service life of the bar and chain depends on good lubrication.

Always use chain lubricating oil of medium viscosity. We recommend special McCulloch chain lubricating oil.

Never use waste oil for this purpose. This results in damage to the bar, the chain and the oil pump.

Refill the chain oil tank each time the saw is refuelled.

To prevent possible restarting problems avoid running the fuel tank dry. This also helps to extend engine life.

NOTE: Saw chain stretches during use particularly when it is new, and it will occasionally be necessary to adjust and tighten it. A new chain will require adjustment after about 5 minutes of operation.

The mechanical oil pump for chain lubrication can be adjusted.

The feed rate of the chain oil pump can be adjusted by means of the regulating screw (A) (see details in the illustration).

STARTING AND STOPPING E

IMPORTANT

Never start or operate unless bar and chain are properly installed. Before starting always move the saw away from the fuelling area and place it on a firm, flat surface, the guide bar to the front.

STARTING A COLD ENGINE

- 1 Check that the chain brake is in the disengaged position moving the lever (L) towards the front handle.
Move the stop switch upwards .
- 2 Slide the choke lever (A) to the CLOSED position (OUT). Push the decompression valve (D) down if your models is fitted with one.
- 3 Depress throttle trigger lock out (S). Depress throttle trigger (G) and then operate throttle advance (P) moving it backwards.
- 4 Hold the saw firmly as shown in illustration and pull the starter rope until the engine fires once.
Beware of moving chain!
- 5 Move choke lever (A) to the OPEN position (IN). Push the decompression valve (D) down if your models is fitted with one.
Pull the starter rope until the engine starts.
Allow engine to warm up for ten seconds for better cutting performance.
Squeeze the throttle trigger (G) to release the throttle advance.
If engine fails to start, repeat these instructions.
- 6 The engine is stopped by depressing the STOP switch to STOP position.

After lengthy use of the chain at full speed, we recommend to run the engine for a few seconds at idle speed before stopping it.

STARTING A WARM ENGINE

Check that the ignition switch is not in the "stop" position and do not use the throttle lock.

Hold the saw firmly, press valve (D) for decompression and pull the starter rope.

STARTING A WARM ENGINE AFTER RE-FUELLING

In the fuel tank as run completely dry, precede to start as with a cold engine.

USAGE F

IMPORTANT

Before using a chain saw read the Operator's Manual and all safety precautions carefully.

FELLING TREES

- Make sure that there are no bystanders or animals in the work area.
 - Study the direction of the fall of the tree and then plan your exit path away from the planned direction of fall.
 - Don't fell trees when there is a strong wind.
- 1 Clear the tree base of interfering limbs and brush. Clean the work area from stones or other objects which could damage the chain. If the tree has large protruding roots, remove them before felling (see illustrations).
 - 2 A) Cut a felling notch (A) of 45° on the side you want the tree to fall to a depth of about one third of the trunk diameter (d). Then make a felling cut (B) about 5 cm higher than the felling notch on the opposite side of the tree. Make sure that the felling cut does not go right through the trunk. A hinge (C) must always be left to provide control over the direction of the fall.
B) Use wedges to control the moment and direction of the fall.
 - 3 When the tree starts to fall, walk away along your preplanned escape path.

CUTTING FALLEN TRUNKS

- 4 A) **Limbing thick branches.** For limbing and bucking leave the lower limbs to support the log off the ground.
 - B) **Supported at one end only.** Begin with a bottom cut made by the upper side of the bar (A); the depth of the cut should be about one third of the log diameter. Finish with a top cut (B) meeting the first one. With this technique splitting, cracking can be avoided
 - C) **Supported at both ends.** Begin with a top cut about one third of the log diameter. Then finish with a bottom cut (B) meeting the first one, this technique avoids the risk of pinching the bar in the log.
 - D) If the log is supported along its whole length it may be cut normally from above. Take care not to touch the ground with the chain.
- When working on a slope always stand on the uphill.
 - When cutting prepared timber, use clamps or chocks to secure work.
 - Use extreme caution when cutting small size brush and saplings which may catch the chain and pull you off balance.

CARBURETTOR ADJUSTMENT

G

We suggest carburetor adjustments are made by an authorised servicing dealer.

The carburetor has three adjustment screws:

- **L:** The needle screw **L** governs the fuel flow at low speed and also the acceleration from low to full speed.
To set screw **L**: close screw **L** turning it clockwise without forcing.
Then open screw 1 full turn (counterclockwise).
If acceleration is not smooth, open another 1/8 turn to increase fuel flow.
- **H:** The needle screw **H** governs fuel flow at high speed (throttle valve fully open).
To set hi speed screw **H**: close screw **H** turning it clockwise without forcing.
Then open screw 1 full turn (counterclockwise).
If the engine speed is too high, open the screw about 1/8 turn (counterclockwise). Optimal adjustment is found between 1 and 1 1/4 turns.
- **I:** The **I** (IDLE) screw controls the throttle opening to govern idle speed (2800 min⁻¹) adjust as necessary.

CAUTION: increased idle speed may cause chain movement. The carburetor is adjusted for normal operation during production. When considerable changes of altitude require a supplementary adjustment, contact an authorised service station which offers the latest in tools, parts and technical assistance.

ROUTINE MAINTENANCE

H

Ensure engine is always switched off before any kind of maintenance operation.

CHAIN: Check tension regularly. A new chain will require more frequent adjustment. Loosen retention nuts. Tighten chain (see assembly instructions). Tighten retention nuts and adjust.

1 BAR

- Clean the bar groove (**K**) and check the lubrication holes (**L**) in the bar to ensure that they are not clogged.
- Grease sprocket periodically. Rotate sprocket and repeat.
- Rotate bar periodically to maximise bar life.

2 AIR FILTER

- A dust clogged air filter may cause carburetor problems. This may prevent the engine from reaching its maximum r.p.m. and cause high fuel consumption.
- Remove cover.
- Wash filter in petrol (do not use fuel which is mixed with oil).
- The filter can also be cleaned with compressed air.
- Replace filter if damaged or if it does not seal tightly in the air box.

3 SPARK PLUG

- Remove and clean the spark plug every 30 hours. Check the electrode gap (0,5/0,6 mm. - 0.025 inches).
- Replace spark plug about every 100 working hours or whenever it is extremely encrusted.

- Heavily encrusted electrodes can result from an incorrect carburetor setting or from wrong fuel mixture (too much oil in the fuel mix) or a poor quality of oil in the fuel mix. Check and correct.

4 OIL FILTER

The oil filter is on the end of the oil suction hose inside the oil tank.

To clean and replace the filter pull it out through the oil tank filter opening. Use a piece of bent wire or long forceps.

To remove deposits from the oil tank half-fill it with kerosene or petrol and shake thoroughly. Drain off and fill the tank with fresh saw chain oil.

Never use waste oil.

5 FUEL FILTER

To change fuel filter remove the tank cap and pull out the filter with a piece of bent wire or long forceps. Replace the filter as shown in the illustration and reposition it.

It is recommended to replace the fuel filter at least once a year.

CHAIN BRAKE

- **WARNING:** Contact your service dealer if anything appears wrong with your chain brake. Do not disassemble or manipulate the mechanism of the chain brake.

- Clean the brake mechanism periodically (without disassembling it) and control the wear of the band visually.

- **PERIODICALLY:** It is important to clean the saw thoroughly particularly around cylinder fins to avoid overheating of the engine.

- **LONG STORAGE:** Empty fuel and run engine until dry.

SAFETY CHAIN BRAKE

I

Your chain saw is fitted with a safety chain brake designed to stop the chain in milliseconds in case of kickback. Always hold the saw firmly in both hands.

The chain brake does not provide a total protection if the machine is used without taking the necessary precautions and maintenances.

The chain brake is intended to engage automatically in case of kickback.

The chain brake can also be engaged manually by pushing the chain brake lever forwards. The manual use of the chain brake is recommended only at idle.

Always test the chain brake before using your saw. Do this by engaging the brake at idle (see below).

Always release the brake before starting.

Kickback may occur if the end of the bar (see illustrated angle) touches any solid object.

Never attempt to start a cut with the end of the bar.

Kickback is a violent upward and rearward movement of the bar and may cause you to lose control of the machine.

Therefore you should avoid starting a cut with this part of the bar. Always keep a firm grip on the saw with both hands because, in case of kickback, it is the contact of the left hand with the brake lever which will help to engage the brake.

CHAIN BRAKE TESTING:

- 1 The chain brake (**A**) is disengaged when brake lever is pulled back and locked (chain can move).

2 The chain brake (A) is engaged when brake lever is in the position (chain cannot rotate). The chain brake should snap into both positions. If strong resistance is felt or lever does not move into either position, DO NOT USE YOUR SAW. Take it immediately to an authorized servicing dealer.

3 CHAIN CATCHER

This unit is fitted with a chain catcher below the drive sprocket. This is intended to stop the rearward movement of the chain in case of breakage or if it should come out of the bar. It should never be removed.

CHAIN SHARPENING



1 Chain cutter teeth can be sharpened with a round file, as follows:

CHAIN	FILE
MP 370 GLX	5/32"
PM 320 GX	3/16"

The exact chain type is marked on the bottom half of the drive link which runs inside the bar groove.

Filing can be made easier by also using a file holder. The chain can remain fitted on the bar during sharpening. Before commencing, the chain should be tensioned correctly and the chain brake should be activated to prevent the chain from moving.

2 To obtain a correct sharpening the file must be carefully held to maintain 3 basic angles:

- "A" Top angle 30° - 35°
- "B" External, side angle 85° - 90°
- "C" Internal, side angle 60°

File in one direction only, from the "inside" of the cutter tooth towards the "outside".

Do not allow the file to touch the chain as you bring it back to re-position it. Each cutter tooth should be filed with the same number of strokes.

3 The file should be held horizontally to the cutter tooth being sharpened.

4 Best results to obtain a precise sideways angle can be obtained by holding the file so that it rises 0,5 mm above the top face of the cutter tooth.

5 DEPTH GAUGE

Correct depth gauge height is vital to ensure maximum chain life and cutting efficiency.

The height of the depth gauge should be lowered as the cutter tooth is filed back; this height should be checked every 4 or 5 sharpenings.

The best way to do this is to use a flat file and a depth gauge tool.

The correct setting is 0.65 mm below the top edge of the cutter tooth.

The cutter tooth depth gauge should then be rounded (D).

FAULT FINDING TABLE

	Engine will not start	Engine runs badly	The chainsaw runs but does not cut well	Engine runs badly or loses power when cutting
Check STOP switch is in the position I.	●			
Control fuel level min. 25% tank capacity.	●	●		
Check air filter is clean.	●	●		
Remove spark plug, dry it, clean it and adjust it, and replace it, if necessary.	●	●		
Control and adjust the carburetor screws if necessary.		●		●
Change fuel filter. Contact your dealer.				●
Carefully follow the chain assembly instructions.			●	
Check chain is sharp. Otherwise, contact your dealer.			●	

Engine still gives trouble: contact your dealer.

000001 → 999999

GB EC Declaration of conformity*In accordance with the EC Machine Directive (98/37/CEE), 93/68/EEC (CE Marking**Directive) & 89/336/EEC (Directive on electromagnetic compatibility) Directive 2000/14/CEE (Annex V).*

The undersigned, Fausto Parazzini, authorised by E.O.P.I., declares that the petrol-driven chainsaw: **MS38E, MS40E, MS46E** serial number as above, with chain bar of cutting length 35/40/45 cm, manufactured by E.O.P.I., Via Como 72, 23868 Valmadrera (LC), Italia, conform to the machine that was the object of the EC type testing in accordance with Annex VI of the Machine Directive.

The EC type examination was conducted by Marchio di Qualità (IMQ), Via Quintiliano 43, 20138 Milano (Italia), EC type examination certificate no. IMQ AQ 024DM, IMQ AQ 025DM, IMQ AQ 026DM.

This type testing established that the machine conforms to the essential health and safety requirements of the EC Machinery Directive.

D EU-Erklärung der Übereinstimmung*Gemäß der Maschinendirektive der 98/37/CEE (Maschinen-richtlinie), 93/68/CEE (CE Kennzeichnungsrichtlinie) & 89/336/CEE (EMV Richtlinie) entsprechen, Richtlinie 2000/14/CEE (Anhang V).*

Der Unterzeichnete Fausto Parazzini, bevollmächtigt durch E.O.P.I., erklärt daß die Kettensägen mit Benzinmotor: **MS38E, MS40E, MS46E** Seriennummer wie oben angegeben, Kettenlänge mit Schneidlänge von 35/40/45 cm, hergestellt durch E.CO.P.I., Via Como 72, 23868 Valmadrera (LC), Italia, der Maschine entsprechen, die Gegenstand der EG-Typenprüfung gemäß Anhang VI der Maschinendirektive war.

Die EG-Typenkontrolle wurde durchgeführt von Marchio di Qualità (IMQ), Via Quintiliano 43, 20138 Milano (Italia), Bescheinigung der EG-Typenkontrolle Nr. IMQ AQ 024DM, IMQ AQ 025DM, IMQ AQ 026DM.

Diese Typenprüfung hat ergeben, daß die Maschine den grundlegenden Gesundheits- und Sicherheitsbestimmungen der EG-Maschinendirektive entspricht.

E Declaracion de cumplimiento de la directriz de la UE*En cumplimiento con la Directiva sobre Maquinaria de la UE (98/37/CEE), 93/68/CEE (Directiva sobre Marcas de la CE)*

& 89/336/CEE (Directiva sobre 'Compatibilidad Electro Magnética') Directiva 2000/14/CEE (Anexo V) El abajo firmante Fausto Parazzini, autorizado por E.O.P.I., declara que las motosierras de gasolina: **MS38E, MS40E, MS46E** con número de serie indicado anteriormente con barra portacadena de longitud de corte de 35/40/45 cm, fabricadas por E.O.P.I., Via Como 72, 23868 Valmadrera (LC), Italia, cumplen con las especificaciones de la máquina objeto de la prueba de la UE conforme al Anexo VI de la Directiva sobre Maquinaria.

La prueba realizada por la UE se llevó a cabo en Marchio di Qualità (IMQ), Via Quintiliano 43, 20138 Milano (Italia), certificado de tipo de prueba de la UE No. IMQ AQ 024DM, IMQ AQ 025DM, IMQ AQ 026DM.

Esta clase de prueba establece que la máquina cumple con las normativas imprescindibles sobre sanidad y seguridad de la Directriz de la UE sobre Maquinaria.

F Déclaration de conformité Européenne*En accord avec la directive européenne (98/37/CEE), 93/68/CEE (Directive Marquage CE) & 89/336/CEE (Directive EMC) Directive 2000/14/CEE (Annexe V).*

Le soussigné Fausto Parazzini, dûment mandaté par E.O.P.I., déclare que, les tronçonneuses thermiques: **MS38E, MS40E, MS46E** dont le numéro de série est cité ci-dessus équipées d'un guide chaîne de 35/40/45 cm de longueur, fabriquées par E.O.P.I., Via Como 72, 23868 Valmadrera (LC), Italia, sont identiques à la machine soumise aux tests européens en accord avec l'annexe VI de la directive ci-dessus. Les tests ont été effectués par Marchio di Qualità (IMQ), Via Quintiliano 43, 20138 Milano (Italia), certificat de tests européens numéro IMQ AQ 024DM, IMQ AQ 025DM, IMQ AQ 026DM.

Ces tests ont établi que la machine est conforme aux recommandations d'hygiène et de sécurité de la directive européenne ci-dessus.

P Declaração de conformidade da CE*De acordo com a Directiva de Máquinas (98/37/CEE), 93/68/CEE (Directiva de Marcação CE) & 89/336/CEE (Directiva de Compatibilidade Electromagnética) Directiva 2000/14/CEE (Apêndice V)*

O abaixo assinado Fausto Parazzini, autorizado por E.O.P.I., declara que: as serras mecânicas a gasolina: **MS38E, MS40E, MS46E** com número de série acima indicado com uma barra de corrente com o comprimento de corte de 35/40/45 cm, fabricada por E.O.P.I., Via Como 72, 23868 Valmadrera (LC), Italia, estão em conformidade com a máquina que foi submetida ao ensaio tipo da CE de acordo com o Anexo VI da Directiva de Máquinas. A inspeção tipo da CE foi efectuada por Marchio di Qualità (IMQ), Via Quintiliano 43, 20138 Milano (Italia). No. de certificado de inspeção tipo da CE no. IMQ AQ 024DM, IMQ AQ 025DM, IMQ AQ 026DM.

Este ensaio tipo constata que a máquina esta em conformidade com os requisitos mínimos de Saude e Segurança de Directiva de Máquinas da CE.

I Dichiarazione di conformità CE*In accordo con la Direttiva Macchine CE (98/37/CEE), 93/68/CEE (Direttiva Marcatura CEE)**& 89/336/CEE (Direttiva Compatibilità Elettromagnetica) Direttiva 2000/14/CEE (Allegato V).*

Il sottoscritto Fausto Parazzini, autorizzato dalla E.O.P.I., dichiara che la sega a catena portatile da legno modello: **MS38E, MS40E, MS46E** numero di serie come sopra riportato, con barra guida catena con lunghezza di taglio da 35/40/45 cm, costruita da E.O.P.I., Via Como 72, 23868 Valmadrera (LC), Italia, è conforme al modello di macchina che è stato sottoposto all'esame per la certificazione CE in accordo con l'allegato VI della Direttiva Macchine. L'esame per la certificazione CE è stato condotto dall'Istituto del Marchio di Qualità (IMQ), Via Quintiliano 43, 20138 Milano (Italia), autorizzato dalla Repubblica Italiana con Decreto Ministeriale del 23/12/1993. Attestato di certificazione CE no. IMQ AQ 024DM, IMQ AQ 025DM, IMQ AQ 026DM.

Questo esame ha stabilito che la macchina è conforme ai requisiti essenziali di salute e di sicurezza della Direttiva Macchine CE.

FIN EU julistus vastaavuudesta*Yhteneväinen EU:n koneista annetun määräyksen (98/37/CEE), 93/68/CEE (CE merkningsdirektiv) & 89/336/CEE (EMC-direktiv) Direktiivi 2000/14/CEE (Liite V).*

Allerkirjoittanut Fausto Parazzini, E.O.P.I., in valtuuttama, vakuuttaa että bensiinimoottorisahat:

MS38E, MS40E, MS46E yllä merkityllä sarjanumerolla, 35/40/45 cm:n ketjulevyllä, E.O.P.I., Via Como 72,

23868 Valmadrera (LC), Italia, valmistama, mukautuu koneseen, joka oli EY tyypitettiin objektit koneohjeellisen Annex VI mukainen.

EY tyypitarkastus oli Marchio di Qualità (IMQ), Via Quintiliano 43, 20138 Milano (Italia), johtama, EY tyypitarkastusodistus

no. IMQ AQ 024DM, IMQ AQ 025DM, IMQ AQ 026DM.

Tämä tyypitesti vahvisti, että kone mukautuu EY koneohjeellisen välttämättömiin terveys- ja turvallisuusmääräyksiin.

N EU Konformitetsdirektiv

I følge EU Maskindirektiv (98/37/CEE), 93/68/CEE (CE-merkingsdirektiv) & 89/336/CEE (Direktiv om elektromagnetiske kompatibilitet) Direktiv 2000/14/CEE (Annex V).

Undertegnede Fausto Parazzini, autorisert av E.O.P.I., erklærer at bensindrevne kjedesåger: **MS38E, MS40E, MS46E** med serienummer som vist ovenfor, med et kjedesverd med skjærelengde 35/40/45 cm, produsert av E.O.P.I., Via Como 72, 23868 Valmadrera (LC), Italia, er i samsvar med den maskinen som var genstand for EU typeprøving i følge Vedlegg VI til Maskindirektivet. EU typeundersøkelsen ble utført av Marchio di Qualità (IMQ), Via Quintiliano 43, 20138 Milano (Italia), EU Typeundersøkelsessertifikat nr. IMQ AQ 024DM, IMQ AQ 025DM, IMQ AQ 026DM.

Denne typeprøvingen fastslø at maskinen tilfredstiller de nødvendige helse- og sikkerhetskravene i EU Maskindirektiv.

S Intyg angående overensstemmelse med EG

I overensstemmelse med EGs Maskindirektiv (98/37/CEE), 93/68/CEE (CE mærkningsdirektiv) & 89/336/CEE (Elektromagnetiske kompatibilitet) Direktiv 2000/14/CEE (Annex V).

Undertecknad Fausto Parazzini, auktoriserad av E.O.P.I., intygar att bensindrivna kedjesågar: **MS38E, MS40E, MS46E** med 35/40/45 cm lång svärd, vars serienummer visas ovan, tillverkade av E.O.P.I., Via Como 72, 23868 Valmadrera (LC), Italia, överensstämmer med den maskin som var föremål för EG-prövning i enlighet med Annex VI av Maskindirektivet.

EG-provet utfördes av Marchio di Qualità (IMQ), Via Quintiliano 43, 20138 Milano (Italia), EG-provets certifikatsnummer IMQ AQ 024DM, IMQ AQ 025DM, IMQ AQ 026DM.

Denna provningsmetod fastställer att maskinen överensstämmer med de väsentliga hälso- och säkerhetsföreskrifterna i EGs Maskindirektiv.

DK EF Konformitetserklæring

I overensstemmelse med EF Maskindirektivet (98/37/CEE), 93/68/CEE (CE mærkningsdirektiv) & 89/336/CEE (EMC-direktiv) Direktiv 2000/14/CEE (Annex V).

Undertegnede Fausto Parazzini, bemyndiget af E.O.P.I., erklærer at benzindrevne kædesåve: **MS38E, MS40E, MS46E** serienummer som angivet ovenfor, med 35/40/45 cm lang kædestang, fremstillet af E.O.P.I., Via Como 72, 23868 Valmadrera (LC), Italia, er i overensstemmelse med den maskine, som var genstand for EF-typeafprøvning ifølge Tillæg VI af Maskindirektivet.

EF-typeundersøgelsen blev gennemført af Marchio di Qualità (IMQ), Via Quintiliano 43, 20138 Milano (Italia),

EF-typeundersøgelsescertifikatnummer IMQ AQ 024DM, IMQ AQ 025DM, IMQ AQ 026DM.

Denne typeafprøvning fastslø, at maskinen er i overensstemmelse med de grundlæggende krav af sikkerhed og sundhed ifølge EF Maskindirektiv.

NL EC Verklaring van Overeenstemming

In overeenstemming met de EC Machine Richtlijn (98/37/CEE), 93/68/CEE (EG Markering Richtlijn) & 89/336/CEE (Richtlijn aangaande elektromagnetische compatibiliteit) Richtlijn 2000/14/CEE (Annex V).

Ondergetekende Fausto Parazzini, gemachtigd door E.O.P.I., verklaart dat de benzine aangedreven kettingzaag:

MS38E, MS40E, MS46E met bovenstaand serienummer met zwaard lengte van 35/40/45 cm, geproduceerd door E.O.P.I., Via Como 72, 23868 Valmadrera (LC), Italia, overeenstemt met de machine die gebruikt is voor het EC type onderzoek volgens de Annex VI van de Machine Richtlijn.

Het EC type onderzoek is uitgevoerd door Marchio di Qualità (IMQ), Via Quintiliano 43, 20138 Milano (Italia), EC type onderzoek certificaat nr. IMQ AQ 024DM, IMQ AQ 025DM, IMQ AQ 026DM.

It typeonderzoek toont aan dat de machine overeenstemt met de fundamentele eisen van veiligheid en gezondheid volgens de Machine Richtlijn.

GR Δήλωση Συμμορφωσης της ΕΚ

Σύμφωνα με την περί Μηχανών Εντολή της ΕΚ (98/37/CEE), 93/68/CEE (η περί του Σήματος CE Εντολή) & 89/336/CEE (η περί Ηλεκτρομαγνητικής Συμβατότητας Εντολή) Κανονισμός 2000/14/CEE (V).

Ο υπογραφομενος Fausto Parazzini, με εξουσιοδότηση της Ε.Ο.Π.Ι., δηλώνω ότι: τα βενζινοκίνητα αλυσοπριονία: **MS38E, MS40E, MS46E** με αλυσιδωτή λαμα μηχανος κοπής 35/40/45 εκ., κατασκευασθέντα από την Ε.Ο.Π.Ι., Via Como 72, 23868 Valmadrera (LC), Italia, ανταποκρίνονται προς τη μηχανή που υπηρξε αντικειμενο εξετασης τυπου της ΕΚ συμφωνα με το Παραρτημα VI της περι Μηχανων Εντολης.

Η εξέταση τυπου της ΕΚ εγινε απο Marchio di Qualità (IMQ), Via Quintiliano 43, 20138 Milano (Italia), (δieuσuθuση), εγγεγραμμενο πρακτορειο του Γαλλικου Δικαιου (Πιστοποιητικο εξετασης τυπου υπι αρ IMQ AQ 024DM, IMQ AQ 025DM, IMQ AQ 026DM).

Με την εξέταση τυπου διαπιστώθηκε ότι η μηχανή συμμορφωνεται προς τις στοιχειωδεις απαιτησεις υγειας και ασφαλειας της περι Μηχανων Εντολης της ΕΚ.

H EC Megegyezési nyilatkozat

Az EC Gépek direktíva (98/37/CEE), 93/68/CEE & 89/336/CEE szerint Direktíva 2000/14/CEE (Melléklet V).

Az alulírott, Fausto Parazzini, a E.O.P.I. feljogosításával, kijelentem hogy a benzinmotoros láncfűrész: **MS38E, MS40E, MS46E** gyártási sorszám a fentiek szerint, egy 35/40/45 cm vágó hosszal rendelkező vezetőláppal, gyártott a E.O.P.I. Via Como 72, 23868 Valmadrera (LC), Olaszország által, megegyezik avval a géppel amelyik tárgya volt az EC típusvizsgálatnak a Gépek direktíva VI Mellékletének megfelelően.

Az EC típusvizsgálat vezetve volt a Marchio di Qualità (IMQ)-nál, Via Quintiliano 43, 20138 Milano, Olaszország, EC típusvizsgálat bizonyítvány szám IMQ AQ 024DM, IMQ AQ 025DM, IMQ AQ 026DM.

Ez a típusvizsgálat megállapította azt, hogy a gép megfelel az EC Gép Direktíva alapvető egészségi és biztonsági követelményeinek.

Electrolux

ELECTROLUX OUTDOOR
PRODUCTS



Fausto Parazzini (Amministratore Delegato),
E.O.P.I., Valmadrera