



**Operator's manual**  
**ROB R600, ROB R800, ROB**  
**R1000**



**EN, English**

**Read the operator's manual carefully and make sure that you understand the instructions before you use the product.**

---

# Contents

---

|   |    |   |    |
|---|----|---|----|
| <b>1 Introduction</b>                                     |    | <b>6 Troubleshooting</b>                        |    |
| 1.1 Introduction.....                                     | 3  | 6.1 Introduction - troubleshooting.....         | 33 |
| 1.2 Product overview.....                                 | 4  | 6.2 Messages.....                               | 33 |
| 1.3 Symbols on the product.....                           | 5  | 6.3 Indicator lamp in the charging station..... | 37 |
| 1.4 Symbols on the display.....                           | 6  | 6.4 Symptoms.....                               | 38 |
| 1.5 Symbols on the battery.....                           | 6  | 6.5 Find breaks in the loop wire.....           | 39 |
| 1.6 Menu structure overview, ROB R600.....                | 7  | <b>7 Transportation, storage and disposal</b>   |    |
| 1.7 Menu structure overview, ROB R800,<br>ROB R1000.....  | 8  | 7.1 Transportation.....                         | 42 |
| 1.8 Display.....  | 9  | 7.2 Storage.....                                | 42 |
| 1.9 Keypad .....  | 9  | 7.3 Disposal.....                               | 42 |
| <b>2 Safety</b>   |    | <b>8 Technical data</b>                         |    |
| 2.1 Safety definitions.....                               | 10 | 8.1 Technical data.....                         | 43 |
| 2.2 General safety instructions.....                      | 10 | <b>9 Warranty</b>                               |    |
| 2.3 Safety instructions for operation.....                | 12 | 9.1 Warranty terms.....                         | 45 |
| <b>3 Installation</b>                                     |    | <b>10 Applicable to US/CA market</b>            |    |
| 3.1 Introduction - Installation.....                      | 15 | 10.1 Supplier's Declaration of Conformity.....  | 46 |
| 3.2 Before the installation of the wires.....             | 15 |   |    |
| 3.3 Before the installation of the product.....           | 15 |   |    |
| 3.4 Installation of the product.....                      | 19 |   |    |
| 3.5 To put the wire into position with stakes...21        |    |   |    |
| 3.6 To bury the boundary wire or the<br>guide wire.....   | 21 |   |    |
| 3.7 To extend the boundary wire or the<br>guide wire..... | 21 |   |    |
| 3.8 After the installation of the product.....            | 21 |   |    |
| 3.9 To do the product settings.....                       | 22 |   |    |
| <b>4 Operation</b>  |    |   |    |
| 4.1 Main switch.....                                      | 27 |   |    |
| 4.2 To start the product.....                             | 27 |   |    |
| 4.3 Operating modes.....                                  | 27 |   |    |
| 4.4 To stop the product.....                              | 28 |   |    |
| 4.5 To switch off the product.....                        | 28 |   |    |
| 4.6 Timer and Standby.....                                | 28 |   |    |
| 4.7 To charge the battery.....                            | 29 |   |    |
| 4.8 Adjust the cutting height.....                        | 29 |   |    |
| <b>5 Maintenance</b>                                      |    |   |    |
| 5.1 Introduction - maintenance.....                       | 30 |   |    |
| 5.2 Clean the product.....                                | 30 |   |    |
| 5.3 Replace the blades.....                               | 31 |   |    |
| 5.4 Firmware update.....                                  | 31 |   |    |
| 5.5 Battery.....  | 31 |   |    |
| 5.6 Winter service.....                                   | 32 |   |    |

---

# 1 Introduction

---

## 1.1 Introduction

|                                  |
|----------------------------------|
| <b>Serial number:</b>            |
| <b>PIN code:</b>                 |
| <b>Product registration key:</b> |

The serial number is on the product rating plate and on the product carton.

- Use the serial number to register your product on [www.mcculloch.com](http://www.mcculloch.com).

### 1.1.1 Support

For support about the McCULLOCH product, speak to your McCULLOCH central service.

### 1.1.2 Product description

**Note:** McCULLOCH regularly updates the appearance and function of the products. Refer to *Support on page 3*.

automatically. Collection of grass is not necessary.

The operator selects the operation settings with the keys on the keypad. The display shows the selected and possible operation settings, and the operation mode of the product.

The boundary wire and the guide wire controls the movement of the product within the work area.

The product is a robotic lawn mower. The product has a battery power source and cuts the grass

## 1.2 Product overview

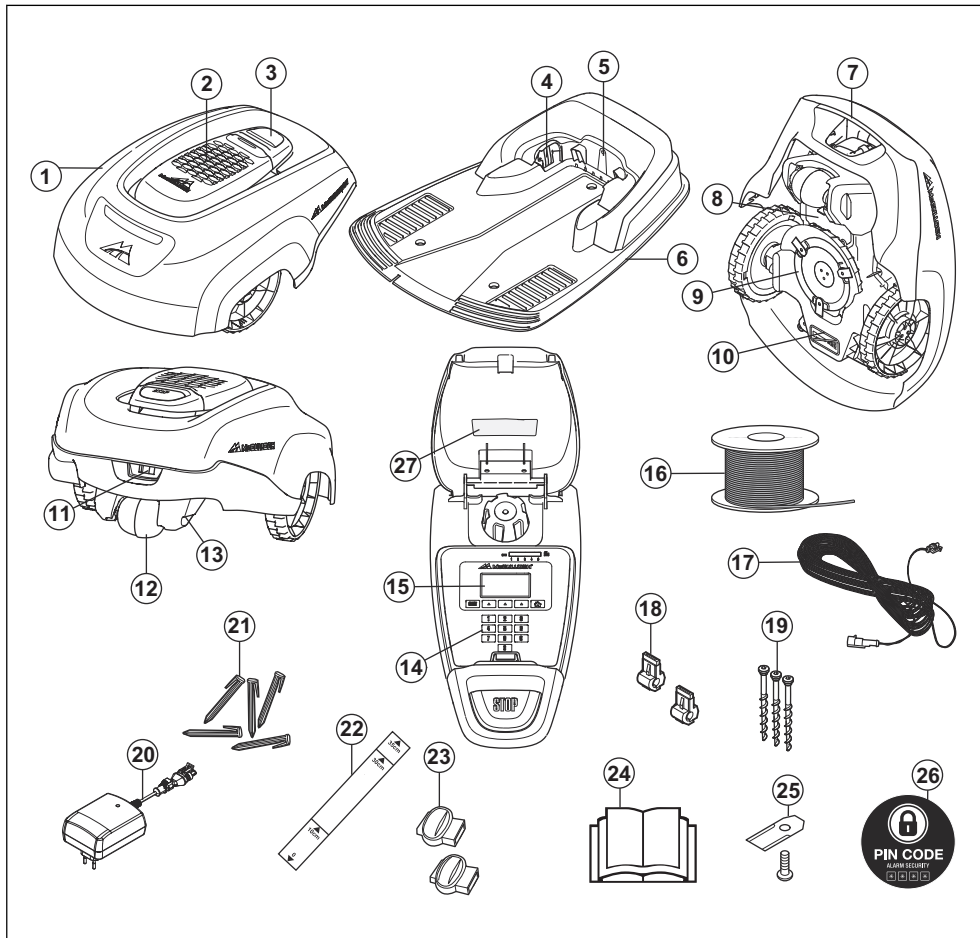

The numbers in the illustration represent:

- |  |  |
|--|--|
| 1. Body  | 9. Blade disc  |
| 2. Cover to display, keypad and cutting height adjustment                        | 10. Chassis box with electronics, battery and motors               |
| 3. Stop button   | 11. Main switch  |
| 4. Contact strips  | 12. Rear wheel   |
| 5. LED for operation check of the charging station, boundary wire and guide wire | 13. Charging strip   |
| 6. Charging station  | 14. Keypad   |
| 7. Carry handle  | 15. Display  |
| 8. Battery cover   | 16. Loop wire for boundary loop and guide wire                     |
|  | 17. Low voltage cable  |
|  | 18. Connector for connecting the loop wire to the charging station |

19. Screws for securing the charging station
20. Power supply (the appearance of the power supply may differ depending on market)
21. Stakes
22. Measurement gauge for help when installing the boundary wire (the measurement gauge is broken loose from the box)
23. Coupler for the loop wire
24. Operator's Manual and Quick Guide
25. Extra blades
26. Alarm decal
27. Rating plate

### 1.3 Symbols on the product

These symbols can be found on the product. Study them carefully.



**WARNING:** Read the user instructions before operating the product.



**WARNING:** Operate the disabling device before working on or lifting the machine.

The product can only start when the main switch is set to 1 and the correct PIN code has been entered. Turn the main switch to 0 before carrying out any inspections and/or maintenance.



**WARNING:** Keep a safe distance from the machine when operating. Keep your hands and feet away from the rotating blades.



**WARNING:** Do not ride on the machine. Never put your hands or feet close to or under the machine.

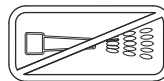

Never use a high-pressure washer or even running water to clean the product.

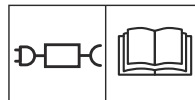

Use a detachable power supply as defined on the rating label next to the symbol.

**CE** This product conforms to the applicable EC Directives.



Noise emission to surroundings. The product's emissions are set out in *Technical data on page 43* and on the rating plate.



It is not permitted to dispose this product as normal household waste. Ensure that the product is recycled in accordance with local legal requirements.



The chassis contains components which are sensitive to electrostatic discharge (ESD). The chassis must also be resealed in a professional manner. For these reasons the chassis shall only be opened by authorized service technicians. A broken seal can result in the entire or parts of the guarantee no longer being valid.



The low voltage cable must not be shortened, extended or spliced. Do not use a trimmer nearby the low voltage cable. Be careful when trimming edges where the cables are placed.

Operate the disabling device before you use or lift the product.

#### 1.4 Symbols on the display



The timer function controls when the product cuts the lawn.



The security function lets the operator select between 3 security levels.



The installation function for manual settings for the installation.



The settings function is where the general settings for the products are set.



The product will not cut the grass due to the timer function.



The battery indicator shows the charge level of the battery. When the product charges the symbol flashes.



The product is put in the charging station but do not charge the battery.



The product is set in ECO-mode.

#### 1.5 Symbols on the battery



Read the user instructions.



Do not discard the battery into fire and do not expose the battery to a heat source.



Do not immerse the battery into water.

## 1.6 Menu structure overview, ROB R600

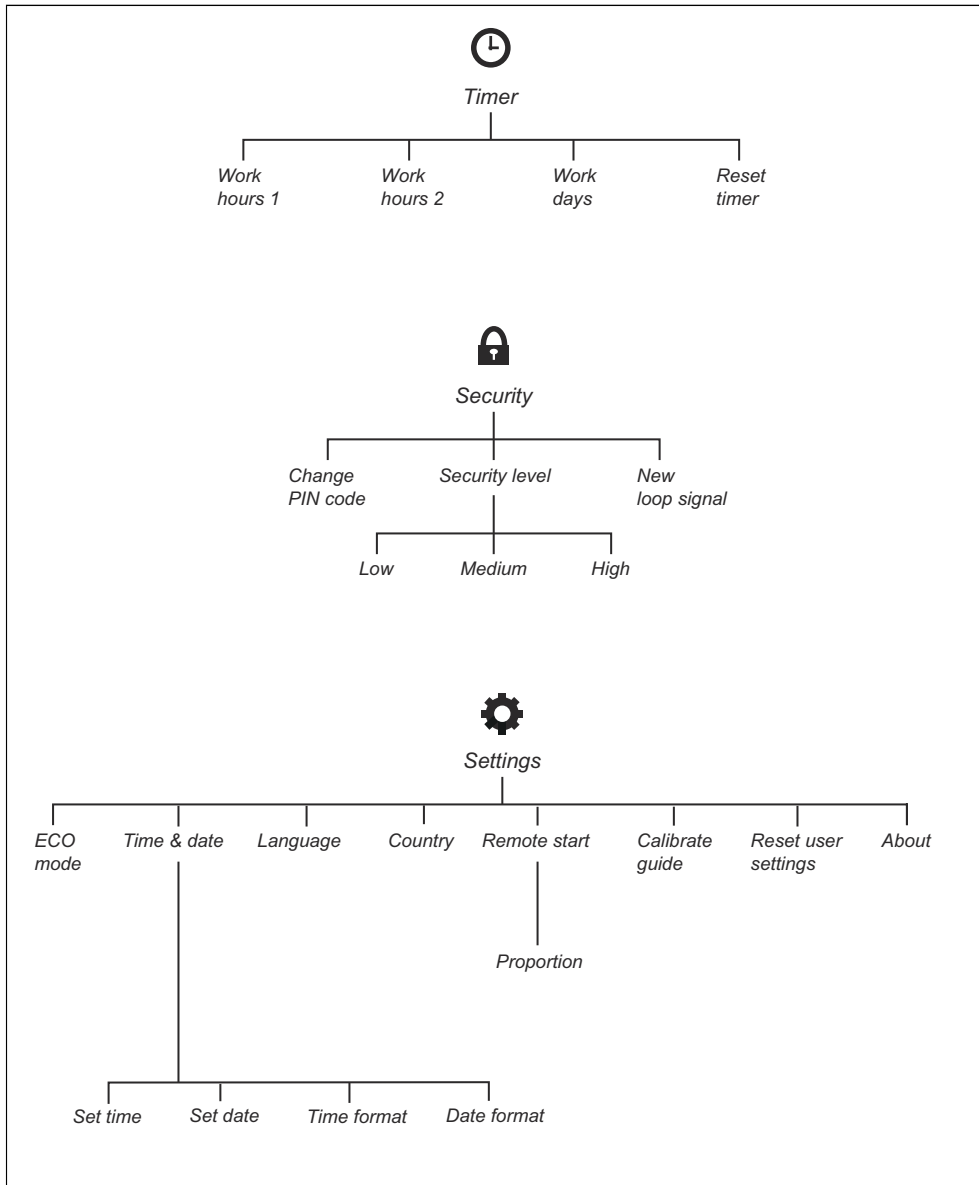

## 1.7 Menu structure overview, ROB R800, ROB R1000

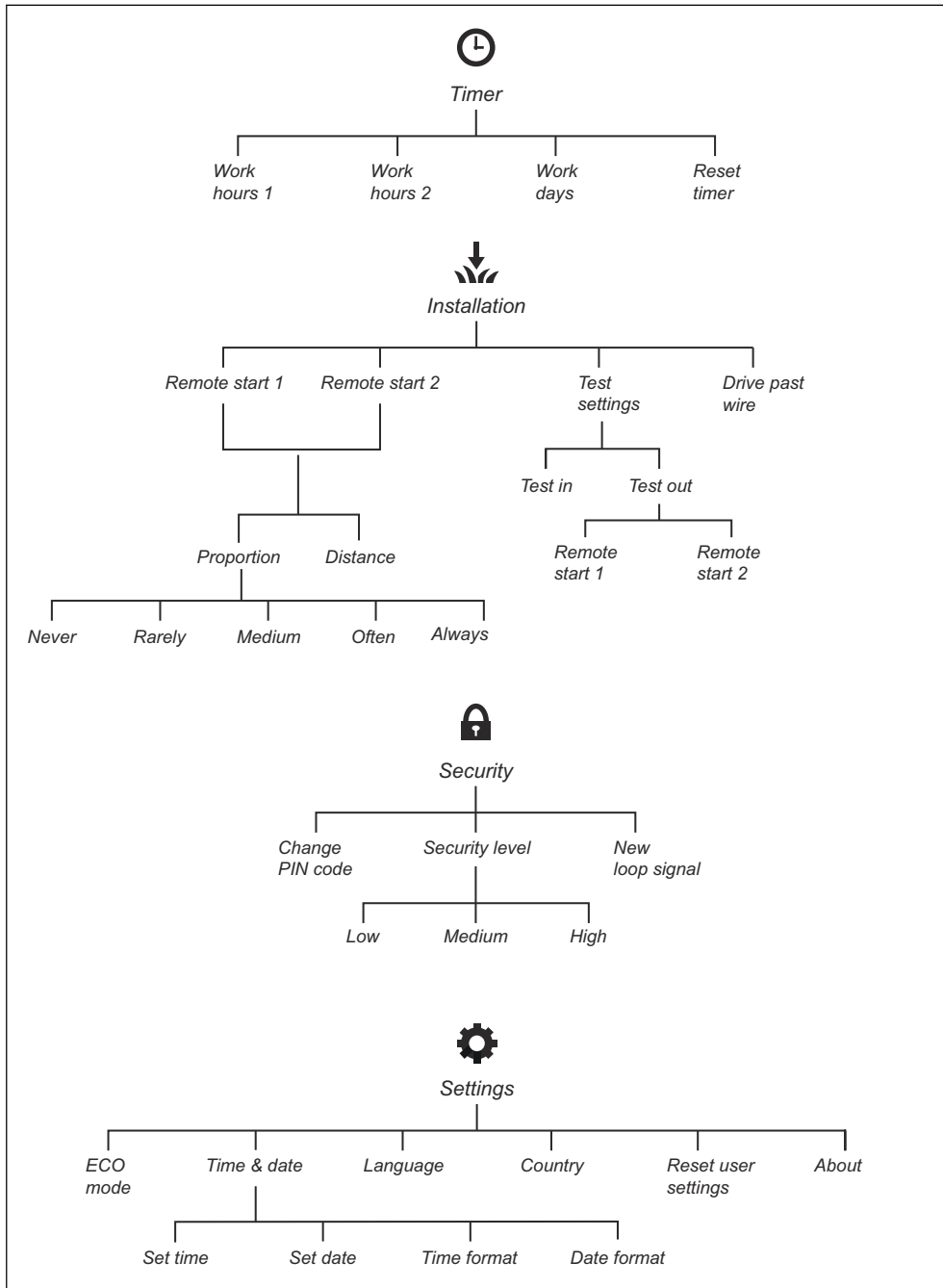



## 1.8 Display

The display on the product shows information and settings of the product.

To access the display, push the **STOP** button.

## 1.9 Keypad

The keypad consists of 4 groups of buttons:

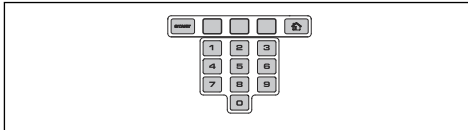

- The **START** button is used to activate the product. This is normally the last button to be pressed before closing the hatch.
- The 3 **multi-choice** buttons offer various functions, depending on where in the menu structure you are.
- The **number keys** are used for instance to enter the PIN code or time settings.
- The **operation selection** button is symbolised by a house. When the button has been pressed, the selected operation mode is shown in the display.

---

## 2 Safety

---

### 2.1 Safety definitions

Warnings, cautions and notes are used to point out specially important parts of the manual.



**WARNING:** Used if there is a risk of injury or death for the operator or bystanders if the instructions in the manual are not obeyed.

---



**CAUTION:** Used if there is a risk of damage to the product, other materials or the adjacent area if the instructions in the manual are not obeyed.

---

**Note:** Used to give more information that is necessary in a given situation.

---

### 2.2 General safety instructions

The following system is used in the Operator's Manual to make it easier to use:

- Text written in *italics* is a text that is shown on the display of the product or is a reference to another section in the Operator's Manual.
- Text written in **bold** is one of the buttons on the keypad of the product.
- Text written in *UPPERCASE* and *italics* refer to the different operating modes available in the product.

## 2.2.1 IMPORTANT. READ CAREFULLY BEFORE USE. KEEP FOR FUTURE REFERENCE

---

The operator is responsible for accidents or hazards occurring to other people or property.

This appliance is not intended for use by persons (including children) with reduced physical, sensory or mental capabilities (that could affect a safe handling of the product), or lack of experience and knowledge, unless they have been given supervision or instruction concerning use of the appliance by a person responsible for their safety.

This appliance can be used by children aged from 8 years and above and persons with reduced physical, sensory or mental capabilities or lack of experience and knowledge if they have been given supervision or instruction concerning use of the appliance in a safe way and understand the hazards involved. Local regulations may restrict the age of the operator. Cleaning and maintenance shall not be made by children without supervision.

Never connect the power supply to an outlet if the plug or cord is damaged. Worn or damaged cord increase the risk of electric shock.

Only charge the battery in the included charging station. Incorrect use may result in electric shock, overheating or leaking of corrosive liquid from the battery. In the event of leakage of electrolyte, flush with water/neutralizing agent. Seek medical help if it comes in contact with the eyes.

Use only original batteries recommended by the manufacturer. Product safety cannot be guaranteed with other than original batteries. Do not use non-rechargeable batteries.

The appliance must be disconnected from the supply mains when removing the battery.

---



**WARNING:** The product can be dangerous if used incorrectly.



**WARNING:** Do not use the product when persons, especially children, or animals, are in the work area.



**WARNING:** Keep your hands and feet away from the rotating blades. Never put your hands or feet close to or under the product when the motor is running.

## 2.3 Safety instructions for operation

### 2.3.1 Use

- The product may only be used with the equipment recommended by the manufacturer. All other types of use are incorrect. The manufacturer's instructions with regard to operation/maintenance must be followed precisely.
- Warning signs shall be placed around the work area of the product if it is used in public areas. The signs shall have the following text: **Warning! Automatic lawnmower! Keep away from the machine! Supervise children!**

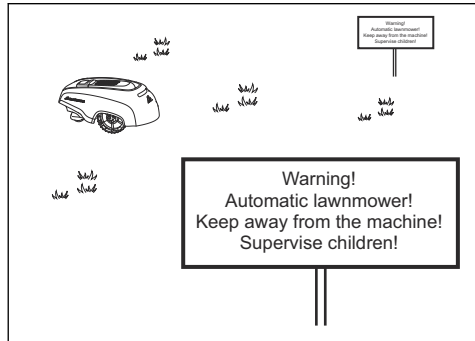

- Use the **HOME** function or switch off the main switch when persons, especially children or animals, are in the work area. It is recommended to program the product for use during hours when the area is free from activity, e.g. at night. Refer to *To do the timer settings on page 22*. Consider that certain species, e.g. hedgehogs, are active at night. They can potentially be harmed by the product.
- The product may only be operated, maintained and repaired by persons that are fully conversant with its special characteristics and safety regulations. Please read the Operator's Manual carefully and make sure you understand the instructions before using the product.
- It is not permitted to modify the original design of the product. All modifications are made at your own risk.
- Check that there are no stones, branches, tools, toys or other objects on the lawn that can damage the blades. Objects on the lawn can also lead to the product getting stuck. Help may be required to remove the object before the product can continue mowing. Always set the main switch in position *0* before clearing a blockage.

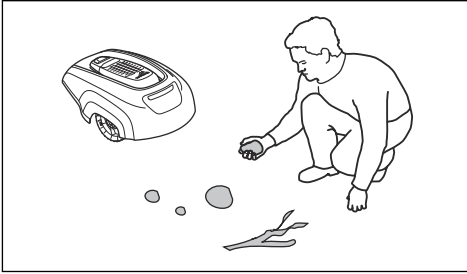

- Start the product according to the instructions. When the main switch is set to 1, make sure to keep your hands and feet away from the rotating blades. Never put your hands and feet under the product.
- Never touch moving hazardous parts, such as the blade disc, before it has come to a complete stop.
- Never lift up the product or carry it around when the main switch is in position 1.
- The product must never be allowed to collide with persons or other living creatures. If a person or other living creature comes in the way of the product, it shall be stopped immediately. Refer to *To stop the product on page 28*.
- Do not put anything on top of the product or its charging station.
- Do not allow the product to be used with a defective guard, blade disc or body. Neither should it be used with defective blades, screws, nuts or cables. Never connect a damaged cable, or touch a damaged cable before it is disconnected from the supply.
- Do not use the product if the main switch does not work.
- Always switch off the product using the main switch when the product is not in use. The product can only start when the main switch is set to 1 and the correct PIN code has been entered.
- The product must never be used at the same time as a sprinkler. Use the timer function so the product and sprinkler never run simultaneously. Refer to *To do the timer settings on page 22*.
- McCULLOCH does not guarantee full compatibility between the product and other types of wireless systems such as remote controls, radio transmitters, hearing loops,

underground electric animal fencing or similar.

- The built-in alarm is very loud. Be careful, especially if the product is handled indoors.
- Metal objects in the ground (for example reinforced concrete or anti-mole nets) can result in a stoppage. The metal objects can cause interference with the loop signal which then can lead to a stoppage.
- Operation and storage temperature is 0-50 °C / 32-122 °F. Temperature range for charging is 0-45 °C / 32-113 °F. Too high temperatures might cause damage to the product.

### 2.3.2 Battery safety



**WARNING:** Lithium-ion batteries can explode or cause fire if disassembled, short-circuited, exposed to water, fire, or high temperatures. Handle carefully, do not dismantle, open the battery or use any type of electrical/mechanical abuse. Avoid storage in direct sunlight.

For more information about the battery, refer to *Battery on page 31*

### 2.3.3 How to lift and move the product

To safely move from or within the work area:

1. Press the **STOP** button to stop the product. If security is set to the medium or high level the PIN code has to be entered. The PIN code contains four digits and is selected when you start the product for the first time. Refer to *To do the basic settings on page 21*.

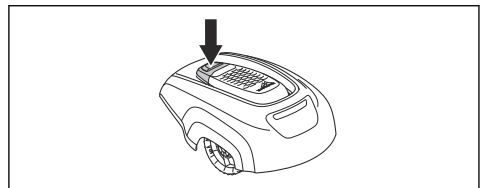

2. Set the main switch in position 0.

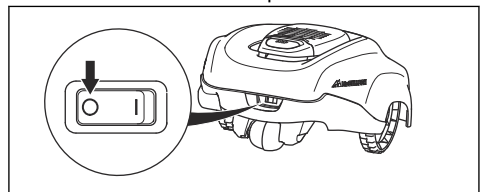

3. Carry the product by the handle under the product with the blade disc away from the body.

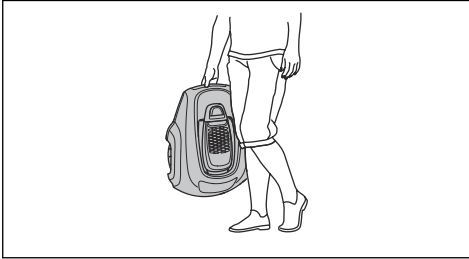

**CAUTION:** Do not lift the product when it is parked in the charging station. It can damage the charging station and/or the product. Press the **STOP** button and pull the product out of the charging station before lifting it.

### 2.3.4 Maintenance



**WARNING:** When the product is turned upside down the main switch must always be in the 0 position.

The main switch should be set in the 0 position before all work on the chassis of the product, such as cleaning or replacing the blades.

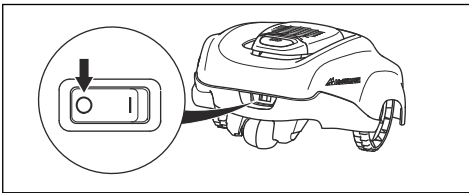

**CAUTION:** Never use a high-pressure washer or even running water to clean the product. Never use solvents for cleaning.



**CAUTION:** Use the plug to disconnect the charging station before any cleaning or maintenance of the charging station or the loop wire.

Inspect the product each week and replace any damaged or worn parts. Refer to *Maintenance on page 30*.

### 2.3.5 In the event of a thunderstorm

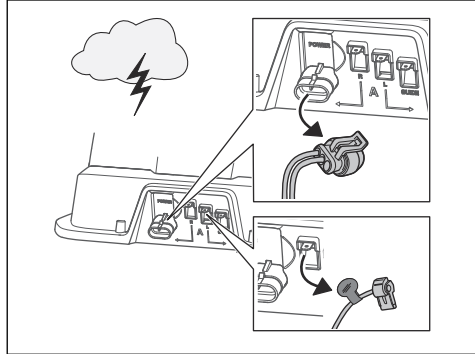

To reduce the risk of damage to electrical components in the product and the charging station, we recommend that all connections to the charging station are disconnected (power supply, boundary wire and guide wire) if there is a risk of a thunderstorm.

1. Mark the wires to simplify reconnecting. The charging station's connections are marked R, L and Guide.
2. Disconnect all connected wires and the power supply.
3. Connect all the wires and the power supply if there is no longer a risk of thunder. It is important that each wire is connected to the right place.

---

## 3 Installation

---

### 3.1 Introduction - Installation



**WARNING:** Read and understand the safety chapter before you install the product.



**CAUTION:** Use original spare parts and installation material.

**Note:** Refer to [www.mcculloch.com](http://www.mcculloch.com) for more information about installation.

### 3.2 Before the installation of the wires

You can select to attach the wires with stakes or bury them. You can use the 2 procedures for the same work area.

- Bury the boundary wire or the guide wire if you are going to use a dethatcher on the work area. If not, attach the boundary wire or guide wire with stakes.
- Cut the grass before you install the product. Make sure that the grass is maximum 4 cm / 1.6 in.

**Note:** The first weeks after installation the perceived sound level when cutting the grass may be higher than expected. When the product has cut the grass for some time, the perceived sound level is much lower.

### 3.3 Before the installation of the product

- Make a blueprint of the work area and include all obstacles.
- Make a mark on the blueprint where to put the charging station, the boundary wire and the guide wire.
- Make an eyelet on the blueprint where the guide wire connects to the boundary wire. Refer to *To examine where to put the boundary wire on page 16*.
- Fill in holes in the lawn.

**Note:** Holes with water in the lawn can cause damage to the product.

### 3.3.1 To examine where to put the charging station

- Keep a minimum 3 m / 9.8 ft. of free space in front of the charging station.
- Keep a minimum of 1.5 m / 4.9 ft. of free space to the right and to the left of the charging station.
- Put the charging station near an outdoor power outlet.
- Put the charging station on a level surface.

Max 3 cm / 1.2"

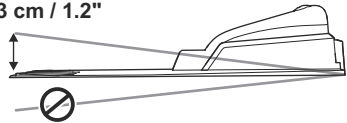

- Put the charging station in the lowest possible section of the work area.
- Put the charging station in an area without an irrigation system.
- Put the charging station in an area with protection from the sun.
- If the charging station is installed on an island, make sure to connect the guide wire to the island. Refer to *To make an island on page 17*.

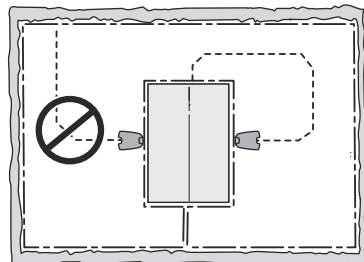

### 3.3.2 To examine where to put the power supply

- Put the power supply in an area with a roof and protection from the sun and rain.
- Put the power supply in an area with good airflow.
- Use a residual-current device (RCD) when you connect the power supply to the power outlet.



**WARNING:** Do not change the power supply. Do not cut or extend the low-voltage cable. There is a risk of electrical shock.

Low-voltage cables of different lengths are available as accessories.



**CAUTION:** Make sure that the blades on the product do not cut the low-voltage cable.



**CAUTION:** Do not put the low-voltage cable in a coil or below the charging station plate. The coil causes interference with the signal from the charging station.



### 3.3.3 To examine where to put the boundary wire

The boundary wire should be put as a loop around the work area. Sensors in the product approach the boundary wire, and the product selects another direction.



**CAUTION:** If the work area is adjacent to water bodies, slopes, precipices or a public road, the boundary wire must have a protective wall. The wall must be minimum 15 cm / 6 in. in height.

To make the connection easier between the guide wire and the boundary wire, it is

recommended to make an eyelet where the guide wire will be connected. Make the eyelet with approximately 20 cm / 8 in. of the boundary wire.

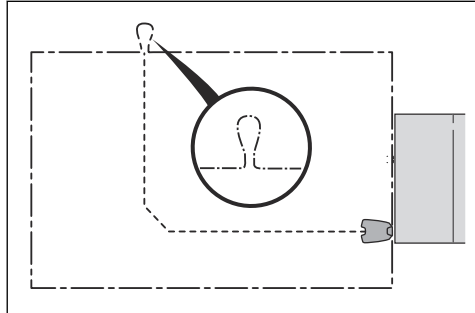

**Note:** Make a blueprint of the work area before you install the boundary wire and guide wire.

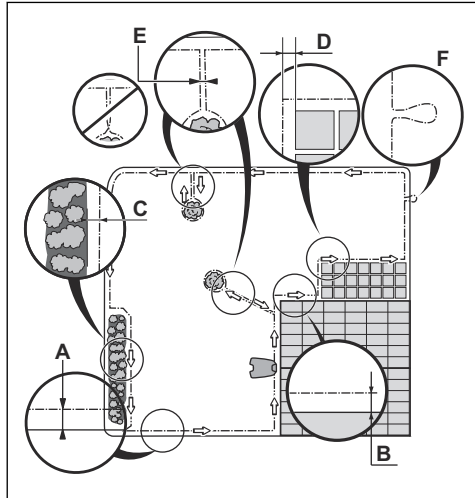

- Put the boundary wire around all of the work area (A). Adapt the distance between the boundary wire and obstacles.
- Put the boundary wire 25 cm / 10 in. (B) from an obstacle that is more than 5 cm / 2 in. high.



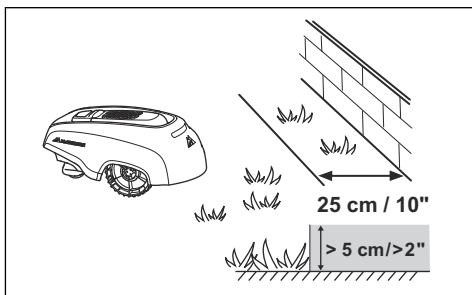

- Put the boundary wire 20 cm / 8 in. (C) from an obstacle that is 1-5 cm / 0.4-2 in. high.
- Put the boundary wire 5 cm / 2 in. (D) from an obstacle that is less than 1 cm / 0.4 in.
- If you have a paving stone path that is in level with the lawn, put the boundary wire below the paving stone.

**Note:** If the paving stone is minimum 30 cm / 12 in. wide, use the factory setting for the *Drive Past Wire* function (ROB R800, ROB R1000) to cut all the grass adjacent to the paving stone.



**CAUTION:** Do not let the product operate on gravel.

- If you make an island, put the boundary wire that runs to and from the island near together (E). Put the wires in the same stake.
- Make an eyelet (F) where the guide wire is to be connected to the boundary wire.



**CAUTION:** Do not make sharp bends when you install the boundary wire.



**CAUTION:** For careful operation without noise, isolate all obstacles such as trees, roots and stones.

### 3.3.3.1 To put the boundary wire in a slope

The product can operate in 25% slopes. Slopes that are too steep must be isolated with the boundary wire. The gradient (%) is calculated as height per m. Example: 10 cm / 100 cm = 10%.

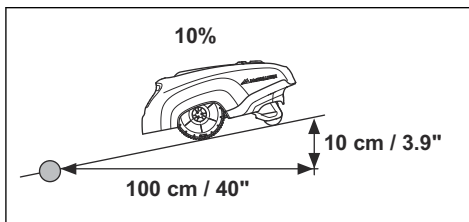

- Slopes steeper than 15% at the outer edge of the work area must be isolated with boundary wire. Put the boundary wire approximately 20 cm / 8 in. (A) on level ground before the slope.

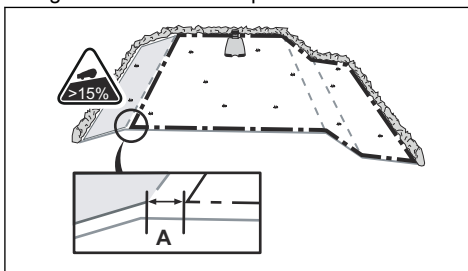

- Slopes adjacent to a public road must be isolated with boundary wire. Put a fence or a protective wall along the outer edge of the slope.

### 3.3.3.2 Passages

A passage is a section that has boundary wire on each side and that connects 2 work areas. The passage must be a minimum of 60 cm / 24 in. wide.

**Note:** If a passage is less than 2 m / 6.5 ft. wide, install a guide wire through the passage.

### 3.3.3.3 To make an island

- Put the boundary wire to and around the obstacle to make an island.
- Put the 2 sections of boundary wire that run to and from the obstacle together.
- Put the 2 sections of boundary wire in the same stake.

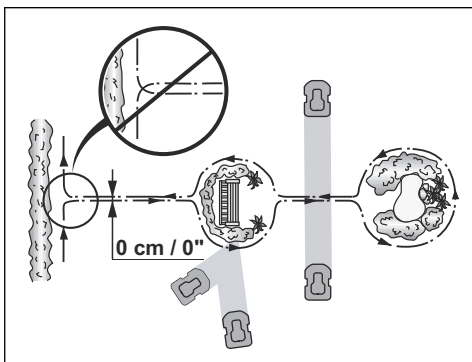

**CAUTION:** Do not put a section of boundary wire across the other. The sections of boundary wire must be parallel.



**CAUTION:** Do not put the guide wire across the boundary wire, for example a boundary wire that goes to an island.

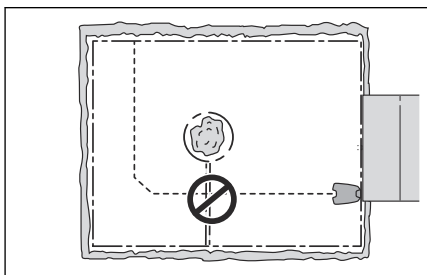

#### 3.3.3.4 To make a secondary area

Make a secondary area (B) if the work area has 2 areas that are not connected with a passage. The work area with the charging station is the main area (A).

**Note:** The product must be manually moved between the main area and the secondary area.

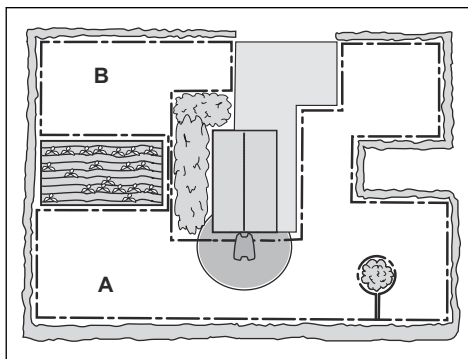

- Put the boundary wire around the secondary area (B) to make an island. Refer to *To make an island on page 17*.

**Note:** The boundary wire must be put as 1 loop around all of the work area (A + B).

**Note:** When the product cuts grass in the secondary area, the *MAN* mode must be selected. Refer to *To make an island on page 17*.

#### 3.3.4 To examine where to put the guide wire

- Put the guide wire in a line at a minimum of 2 m / 7 ft. in front of the charging station.
- Make sure that the guide wire has as much free area as possible to the left of the guide wire when facing the charging station. Refer to *Guide calibration on page 21*.
- Put the guide wire minimum 30 cm / 12 in. from the boundary wire.
- Do not make sharp bends when you install the guide wire.
- If the work area has a slope, put the guide wire diagonally across the slope.

### 3.3.5 Work area examples

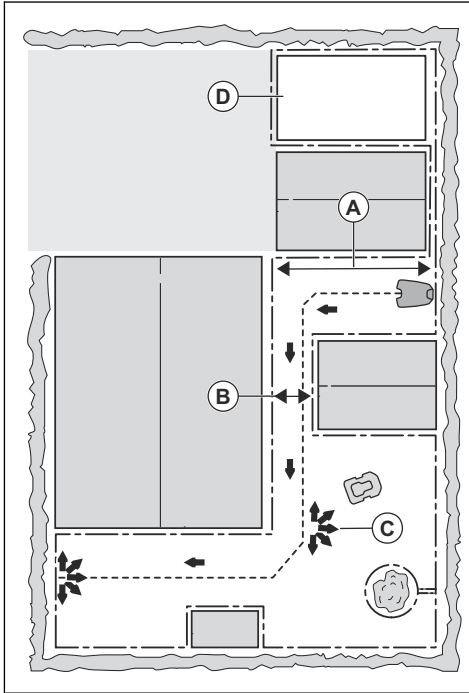

- If the charging station is put in a small area (A), make sure that the distance to the boundary wire is at a minimum 3 m / 10 ft.
- If the work area has a passage (B), make sure that the distance to the boundary wire is at a minimum 2 m / 6.6 ft. If the passage is smaller than 2 m / 6.6 ft., install a guide wire through the passage. Minimum passage between the boundary wire is 60 cm / 24 in.
- If the work area has areas which are connected by a narrow passage (B), you can set the product to leave the guide wire after a certain distance (C). The settings can be changed in *Remote start 1 on page 23*.
- If the work area includes a secondary area (D), refer to *To make a secondary area on page 18*. Put the product in the secondary area and select *Proportion*.

## 3.4 Installation of the product

### 3.4.1 To install the charging station



**WARNING:** Obey national regulations about electrical safety.

1. Read and understand the instructions about the charging station. Refer to *To examine where to put the charging station on page 15*.
2. Put the charging station in the selected area.
3. Connect the low-voltage cable to the charging station.
4. Put the power supply at a minimum height of 30 cm / 12 in.

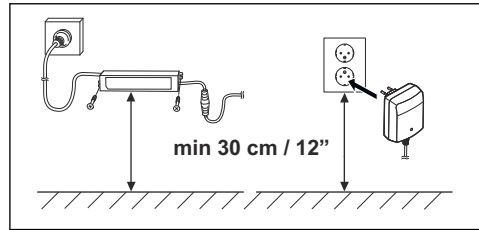

**WARNING:** Do not put the power supply at a height where there is a risk it can be put in water. Do not put the power supply on the ground.



**WARNING:** Do not encapsulate the power supply. Condensed water can harm the power supply and increase the risk of electrical shock.

5. Connect the power supply cable to a 100-240V outdoor power outlet.



**WARNING:** Applicable to USA/ Canada. If power supply is installed outdoors: Risk of Electric Shock. Install only to a covered Class A GFCI receptacle (RCD) that has an enclosure that is weatherproof with the attachment plug cap inserted or removed.

- Put the low-voltage cable in the ground with stakes or bury the cable. Refer to *To put the wire into position with stakes on page 21* or *To bury the boundary wire or the guide wire on page 21*.
- Connect the wires to the charging station. Refer to *To install the boundary wire on page 20* and *To install the guide wire on page 20*.
- Attach the charging station to the ground with the supplied screws.



**CAUTION:** Do not make new holes in the charging station plate.



**CAUTION:** Do not put your feet on the charging station.

### 3.4.2 To install the boundary wire

- Put the boundary wire around all of the work area. Start and complete the installation behind the charging station.



**CAUTION:** Do not put unwanted wire in a coil. The coil causes interference with the product.

- Open the connector and put the boundary wire in the connector.

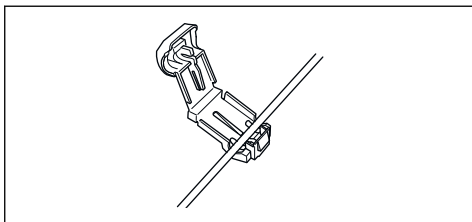

- Close the connector with a pair of pliers.
- Cut the boundary wire 1-2 cm / 0.4-0.8 in. above each connector.
- Push the right connector onto the metal pin on the charging station with the mark "R".
- Push the left connector onto the metal pin on the charging station with the mark "L".

### 3.4.3 To install the guide wire

- Open the connector and put the wire in the connector.
- Close the connector with a pair of pliers.

- Cut the guide wire 1-2 cm / 0.4-0.8 in. above each connector.
- Push the guide wire through the slot in the charging station plate.
- Push the connector onto the metal pin on the charging station with the mark "G".
- Put the end of the guide wire at the eyelet on the boundary wire.
- Cut the boundary wire with a pair of wire cutters.
- Connect the guide wire to the boundary wire with a coupler.

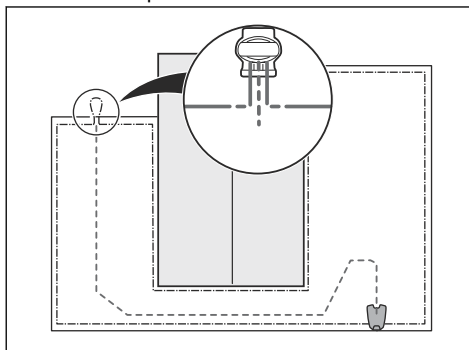

- Put the 2 ends of the boundary wire and the end of the guide wire into the coupler.

**Note:** Make sure that you can see the end of the guide wire through the transparent area of the coupler.

- Push the button on the coupler with an adjustable pliers.



**CAUTION:** Twinned cables, or a screw terminal block that is insulated with insulation tape are not satisfactory splices. Soil moisture will cause the wire to oxidize and after a time result in a broken circuit.

- Attach the guide wire to the ground with stakes or bury the guide wire in the ground. Refer to *To put the wire into position with stakes on page 21* or *To bury the boundary wire or the guide wire on page 21*.

### 3.5 To put the wire into position with stakes

- Put the boundary wire and the guide wire on the ground.
- Put the stakes at a maximum of 75 cm / 30 in. distance from each other.
- Attach the stakes to the ground with a hammer or a plastic mallet.



**CAUTION:** Make sure that the stakes hold the boundary wire and the guide wire against the ground.

**Note:** The wire is overgrown with grass and not visible after a few weeks.

### 3.6 To bury the boundary wire or the guide wire

- Cut a groove in the ground with an edge cutter or a straight shovel.
- Put the boundary wire or the guide wire 1-20 cm / 0.4-8 in. into the ground.

### 3.7 To extend the boundary wire or the guide wire

**Note:** Extend the boundary wire or the guide wire if it is too short for the work area. Use original spare parts, for example couplers.

1. Cut the boundary wire or the guide wire with a pair of wire cutters where it is necessary to install the extension.
2. Add wire where it is necessary to install the extension.
3. Put the boundary wire or the guide wire into position.
4. Put the wire ends into a coupler.

**Note:** Make sure that you can see the ends of the boundary wire or the guide wire through the transparent area of the coupler.

5. Push the button on the coupler with an adjustable pliers.

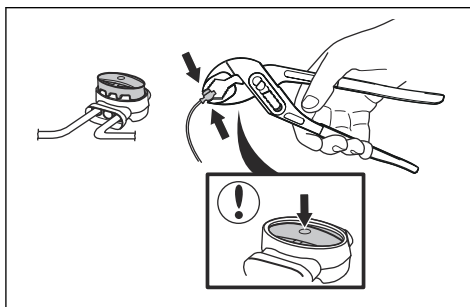

6. Put the boundary wire or the guide wire into position with stakes.

## 3.8 After the installation of the product

### 3.8.1 To do a visual check of the charging station

1. Make sure that the indicator LED lamp on the charging station has a green light.
2. If the indicator LED lamp does not have a green light, do a check of the installation. Refer to *Indicator lamp in the charging station on page 37* and *To install the charging station on page 19*.

### 3.8.2 To do the basic settings

Before you start the product for the first time, you must do the basic settings and calibrate the product.

1. Push the **STOP** button.
2. Set the **Main switch** to 1.
3. Push the **multi-choice** buttons. Select *language, country, date, time* and set a PIN code.

**Note:** It is not possible to use 0000 as PIN code.

4. Put the product in the charging station.
5. Push the **START** button and close the hatch.

The product then moves away from the charging station and stops, while it calibrates some of the product settings.

### 3.8.3 Guide calibration

The calibration process sets as wide guide corridor as possible to reduce the risk of tracks forming on the lawn. Refer to *To set the Calibrate guide function (ROB R600) on page 25*.

**Note:** The product always runs to the left of the guide wire (as seen facing the charging station).

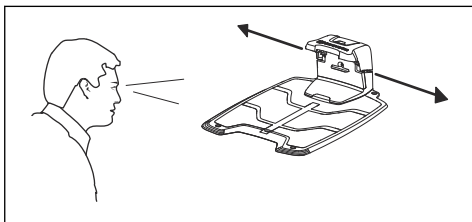

## 3.9 To do the product settings

The product has factory settings but the settings can be adapted to each work area.

### 3.9.1 To get access to the menu

1. Push the **STOP** button.
2. Enter the PIN code on the keypad.
3. Push the **MENU** button.

### 3.9.2 To do the timer settings



#### 3.9.2.1 To calculate the timer setting

1. Calculate the dimension of your lawn in  $m^2$  /  $yd^2$ .
2. Divide the  $m^2$  /  $yd^2$  of the lawn with the approximate operation capacity. Refer to table below.
3. The result is equal to the number of hours that the product must operate each day.

**Note:** The operation capacity is approximate and timer settings can be adjusted.

| Model     | Approximate operation capacity, $m^2$ / $yd^2$ / h |
|-----------|--|
| ROB R600  | 43 / 51  |
| ROB R800  | 50 / 59  |
| ROB R1000 | 48 / 57  |

Example: A lawn of  $500 m^2$  /  $600 yd^2$ , cut with a ROB R1000.

$$500 m^2 / 48 \approx 10.5 \text{ h.}$$

$$600 yd^2 / 57 \approx 10.5 \text{ h.}$$

| Days / week | h / day | Timer settings                  |
|-------------|---------|---------------------------------|
| 7           | 10.5    | 07:00-17:30 / 7:00 am - 5:30 pm |

#### 3.9.2.2 To set the timer

1. Do steps 1–3 in *To get access to the menu on page 22*.
2. Use the **multi-choice** buttons to move through the menu structure to select *Timer*.
3. Use the **multi-choice** buttons to select *Work hours 1* or *Work hours 2*.
4. Enter the time with the **number buttons**.
5. Push *OK*.
6. Use the **multi-choice** buttons to select *Work days*.
7. Use the **multi-choice** buttons to select the days that the product will operate.
8. Push *OK*.

#### 3.9.2.3 To reset the timer setting

You can remove all timer settings and use the factory setting. The factory timer setting lets the product operate all hours each day of the week. Refer to *Timer and Standby on page 28*.

1. Do steps 1–3 in *To get access to the menu on page 22*.
2. Use the **multi-choice** buttons to move through the menu structure *Timer > Reset timer*.
3. Push *OK*.

## 3.9.3 Installation (ROB R800, ROB R1000)



In the Installation menu it is possible to adapt the settings of the product for best mowing result.

### 3.9.3.1 Guide width

The guide width is a measure of how far from the guide wire the product is allowed to travel when it follows this to and from the charging station. The area beside the wire which the product uses is called the Corridor.

The product has a default setting for *Medium* wide corridors. To further reduce the risk of tracks forming, it is recommended to select as wide corridor as possible. The *Narrow* corridor setting is not normally recommended, but in a garden with one or many narrow passages, a narrow corridor may be the only option. The *Narrow* corridor setting increases the risk for tracks forming along the guide.

### 3.9.3.2 Remote start 1

The *Remote start* function is used to guide the product to remote parts of the work area. If the work area includes areas that are connected with narrow passages, the *Remote start* function is useful to be able to maintain a well-cut lawn in all parts of the yard. The product begins to mow when it reaches the *Remote start* point. At all other times, the product leaves the charging station in the standard manner and starts to mow.

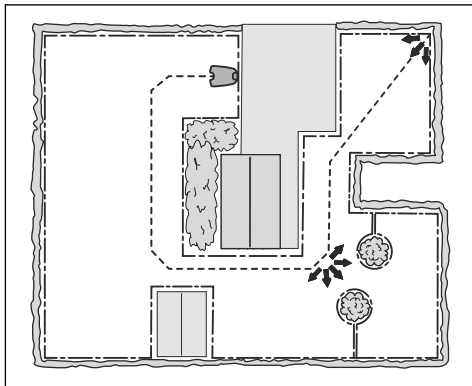

#### To set the Remote start function

1. Do steps 1–3 in *To get access to the menu on page 22*.
2. Use the **multi-choice** buttons to move through the menu structure to select *Installation > Remote start > Proportion*.
3. Select how often the *Remote start* function shall be used. There are 5 options:
  - Never (0%)
  - Rarely (approx. 20%)
  - Medium (approx. 50%)
  - Often (approx. 80%)
  - Always (100%)
4. Select the distance from the charging station to the *Remote start*.

5. Push *OK*.

### 3.9.3.3 Remote start 2

If the work area contains 2 remote areas, the guide wire should be installed so that it reaches both areas. *Remote start 1* and *Remote start 2* can then be combined to steer the product to each area.

The settings for *Proportion* and *Distance* are carried out in the same way as for *Remote start 1*. The factory setting is *Never*.

---

**Note:** The sum of *Proportion* for *Remote start 1* and *Remote start 2* cannot exceed 100%.

---

If you have for instance selected *Often* for *Remote start 1*, then you can only select *Never* or *Rarely* for *Remote start 2*.

#### To measure the distance from the charging station

1. Put the product in the charging station.
2. Do steps 1–3 in *To get access to the menu on page 22*.
3. Use the **multi-choice** buttons to move through the menu structure *Installation > Remote start 1 or Remote start 2 > Distance*.
4. Use the **number** buttons to set *m* as a distance.
5. Push *OK*.
6. Use the **multi-choice** buttons to move through the menu structure *Installation > Test settings > Test OUT*.
7. Push *OK*.
8. Push the **STOP** button when the product is at the distance you select to measure. The distance shows in the display.

### 3.9.3.4 Test settings

In the *Test settings* menu, it is possible to test how the settings for *Remote start 1* and *Remote start 2* work in the work area in question.

#### To do a test of the Remote start function

1. Put the product in the charging station.
2. Do steps 1-3 in *To get access to the menu on page 22*.
3. Use the **multi-choice** buttons to move through the menu structure *Installation >*

*Test settings > Test OUT > Remote start 1 or Remote start 2.*

4. Push **OK**.
5. Push the **START** button.
6. Close the hatch.
7. Make sure the product can find the area.

### 3.9.3.5 To set the Drive Past Wire function

The front of the product always moves past the boundary wire by a specified distance before the product moves back into the work area. The factory setting is 25 cm. You can select a distance of 20-30 cm.

1. Do steps 1–3 in *To get access to the menu on page 22*.
2. Use the **multi-choice** buttons to move through the menu structure *Installation > Drive Past Wire*.
3. Use the **number** buttons to set the distance in cm.
4. Push the **BACK** button.

## 3.9.4 Security level



There are 3 security levels for the product.

| Function    | Low | Medium | High |
|-------------|-----|--------|------|
| Alarm       |     |        | X    |
| PIN request |     | X      | X    |
| Time lock   | X   | X      | X    |

- **Alarm** - An alarm goes off if the PIN-code is not entered within 10 seconds after the **STOP** button is pushed. The alarm also goes off when the product is lifted. The alarm stops when the PIN-code is entered.
- **PIN-code** - The correct PIN-code must be entered to get access to the Menu structure of the product. If the incorrect PIN-code is entered 5 times, the product is locked for some time. The lock is extended for each new incorrect try.
- **Time lock** - The product is locked if the PIN-code has not been entered in 30 days. Enter the PIN-code to get access to the product.

### 3.9.4.1 To change the PIN code

1. Do steps 1–3 in *To get access to the menu on page 22*.
2. Use the **multi-choice** buttons to move through the menu structure *Security > Change PIN code*.
3. Enter the new PIN code.
4. Push **OK**.
5. Enter the new PIN code.
6. Push **OK**.
7. Make a note of the new PIN code. Refer to *Introduction on page 3*.

### 3.9.4.2 To set the security level

Select 1 of 3 security levels for your product.

1. Do steps 1–3 in *To get access to the menu on page 22*.
2. Use the **multi-choice** buttons to move through the menu structure *Security > Security level*.
3. Use the **multi-choice** buttons to select the level of security.
4. Push **OK**.

### 3.9.4.3 To create a New loop signal

The loop signal is randomly selected to create a unique link between the product and the charging station. In rare cases, there may be a need to generate a new signal, for instance if two adjacent installations have a very similar signal.

1. Place the product in the charging station.
2. Do steps 1–3 in *To get access to the menu on page 22*.
3. Use the **multi-choice** buttons to move through the menu structure *Security > New loop signal*.
4. Push **OK** and await confirmation that the loop signal has been generated. This normally takes about 10 seconds.

## 3.9.5 Settings



In settings you can change the general settings to your product.



### 3.9.5.1 ECO mode

*ECO mode* stops the signal in the boundary loop, the guide wire and the charging station, when the product is parked or is charging.

---

**Note:** Use *ECO mode* to save energy and avoid interference with other equipment, for example hearing loops or garage doors.

---

---

**Note:** Push the **STOP** button before you remove the product from the charging station. If not, the product can not be started in the work area.

---

#### To set the ECO mode

1. Do steps 1–3 in *To get access to the menu on page 22*.
2. Use the **multi-choice** buttons to move through the menu structure *Settings > ECO mode*.
3. Push *OK*.

#### 3.9.5.2 To set the Time & Date

1. Do steps 1–3 in *To get access to the menu on page 22*.
2. Use the **multi-choice** buttons to move through the menu structure *Settings > Time & Date*.
3. Use the **number** buttons to set the time and then push *OK*.
4. Use the **number** buttons to set the date and then push *OK*.
5. Use the **multi-choice** buttons to set the time format and then push *OK*.
6. Use the **multi-choice** buttons to set the date format and then push *OK*.

#### 3.9.5.3 To set the language

1. Do steps 1–3 in *To get access to the menu on page 22*.
2. Use the **multi-choice** buttons to move through the menu structure *Settings > Language*.
3. Use the **multi-choice** buttons to select language and then push *OK*.

#### 3.9.5.4 To set the country

1. Do steps 1–3 in *To get access to the menu on page 22*.

2. Use the **multi-choice** buttons to move through the menu structure *Settings > Country*.
3. Use the **multi-choice** buttons to select country and then push *OK*.

#### 3.9.5.5 To set the Remote start function (ROB R600)

1. Do steps 1–3 in *To get access to the menu on page 22*.
2. Use the **multi-choice** buttons to move through the menu structure to select *Installation > Remote start > Proportion*.
3. Select how often the *Remote start* function shall be used. There are 5 options:
  - Never (0%)
  - Rarely (approx. 20%)
  - Medium (approx. 50%)
  - Often (approx. 80%)
  - Always (100%)
4. Push *OK*.

#### 3.9.5.6 To set the Calibrate guide function (ROB R600)

The *Calibrate guide* function allows you to test if the product can follow the guide wire out from the charging station.

1. Place the product in the charging station.
2. Do steps 1–3 in *To get access to the menu on page 22*.
3. Use the **multi-choice** buttons to move through the menu structure *Settings > Calibrate guide* and push *OK*.  
The product will leave the charging station, run a calibration process in front of the charging station and then follow the guide wire to the connection point with the boundary wire and then start mowing
4. Check that the product can follow the guide wire all the way to the connection point with the boundary wire.

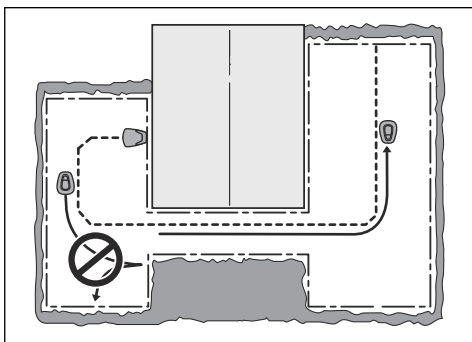

The test has failed if the product cannot follow the guide wire all the way to the connection point with the boundary wire. It is likely that the installation has not been carried out in accordance with the instructions in *To install the guide wire on page 20*.

---

**Note:** Common errors are for instance that there is not enough open space to the left of the guide wire as seen facing the charging station, or that the guide wire is not laid at an angle on a steep slope. Refer to *To examine where to put the guide wire on page 18*.

---

If the test fails, rectify the installation and run a new test with *Calibrate guide*.

#### 3.9.5.7 To reset all user settings

1. Do steps 1–3 in *To get access to the menu on page 22*.
2. Use the **multi-choice** buttons to move through the menu structure *Settings > Reset user settings*.
3. Use the **multi-choice** buttons to select country and then push *OK*.
4. Enter the PIN code.
5. Push *OK* to reset all the user settings.

---

**Note:** *Security level, PIN code, Loop signal, Messages, Date & Time, Language and Country settings* are not reset.

#### 3.9.5.8 The About menu

The *About* menu displays information about the product, for example serial number and firmware versions.

## 4 Operation

### 4.1 Main switch



**WARNING:** Read the safety instructions carefully before you start the product.



**WARNING:** Keep your hands and feet away from the rotating blades. Never put your hands or feet close to or under the product when the motor is running.



**WARNING:** Do not use the product when persons, especially children, or animals, are in the work area.

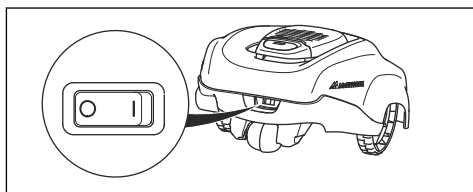

- Set the **Main switch** in the *1* position to start the product.
- Set the **Main switch** in the *0* position when the product is not in use or before any work, inspection or maintenance is being carried out.

When the **Main switch** is set in the *0* position the motors on the product cannot start.

### 4.2 To start the product

1. Press the **STOP** button to open the hatch.
2. Set the main switch to position *1*.
3. Enter the PIN code.
4. Push the **START** button.

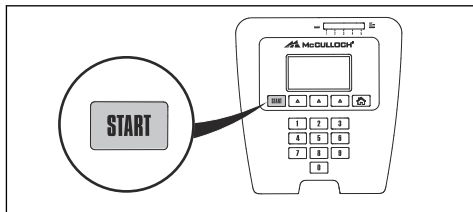

5. Close the hatch.

**Note:** If the product is parked in the charging station, the product will only leave the charging station when the battery is fully charged and if the timer allows the product to operate.

**Note:** Press the **START** button before closing the hatch to start the product. If the **START** button is not pressed, a message beep is heard and the product will not start.

### 4.3 Operating modes

The operating mode button is symbolized by a house. When the **Mode** button is pressed the following operating modes can be selected:

- Home
- Auto
- Man

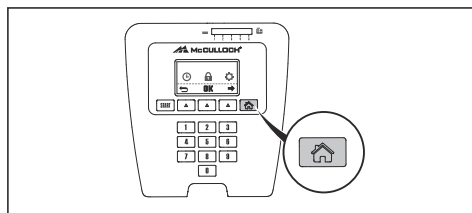

#### 4.3.1 Home mode

Operating mode *Home* means that the product remains in the charging station until a different operating mode is selected. The *Home* mode is also used to test if the product can follow the guide wire and dock with the charging station.

#### 4.3.2 Auto mode

The *Auto* mode is the standard operating mode where the product mows and charges automatically.

#### 4.3.3 Manual mode

To mow secondary areas the operating mode *Man* must be chosen. In the *Man* mode, the operator must move the product manually between the main area and the secondary area. The product mows until the battery is empty.

When the battery is empty, the product stops and the message *Needs manual charging* shows in the product display. Put the product in the charging station to charge the battery. When the battery is charged, the product moves out of the charging station and stops. The product is now prepared to start operation, but needs confirmation from the operator first.

**Note:** If you want to cut the main area after the battery is charged, set the product to *Auto* mode before placing it in the charging station.

#### 4.4 To stop the product

1. Press the **STOP** button on top of the product.

The product stops and the blade motor stops.

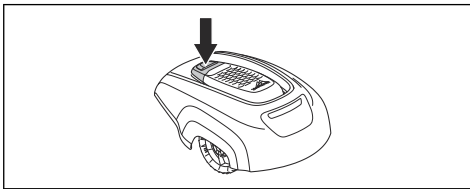

#### 4.5 To switch off the product

1. Press the **STOP** button on top of the product.
2. Set the **Main switch** to position 0.

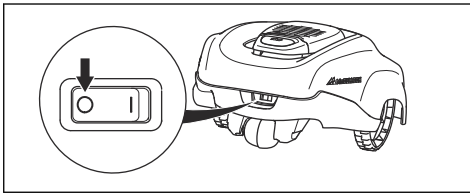

**WARNING:** Always switch off the product using the main switch if it requires maintenance, or if the product must be moved outside the work area.

#### 4.6 Timer and Standby

Use the timer function to avoid a downtrodden lawn. Refer to *To do the timer settings on page 22*.

#### 4.6.1 Standby

The robotic lawnmower has an inbuilt standby period according to the Standby time table. The standby period provides for instance a good opportunity to water or play games on the lawn.

| Model               | Standby time, minimum hours per day |
|---------------------|-------------------------------------|
| McCULLOCH ROB R600  | 11                                  |
| McCULLOCH ROB R800  | 8                                   |
| McCULLOCH ROB R1000 | 4                                   |

#### 4.6.2 Example 1

This example is applicable to products with a specified work area of 1000 m<sup>2</sup>, but the principle is the same for the other models.

Timer setting, Period 1: 00:00-22:00

Active period (A): 08:00-20:00

The timer setting ensures that the product begins cutting the lawn at 00:00. However the product is parked in standby mode in the charging station from 20:00 and rests until it starts cutting again at 00:00.

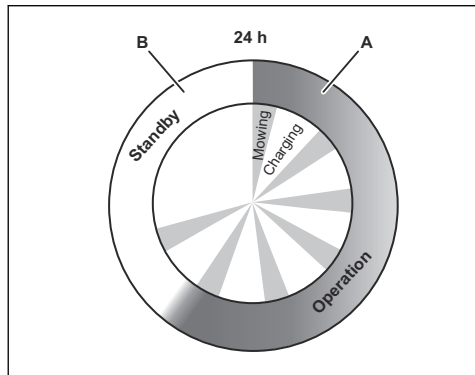

**Example: A specified work area of 1000 m<sup>2</sup>**

|                                  |    |
|----------------------------------|----|
| Operation, A = max. hours        | 20 |
| Charging/Standby, B = min. hours | 4  |

### 4.6.3 Example 2

This example is applicable to products with a specified work area of 1000 m<sup>2</sup>, but the principle is the same for the other models.

The timer settings can be divided into 2 work periods to prevent mowing when there usually is other activities ongoing. If the timer setting is divided into 2 work periods, the minimum standby period must in total be according to the Standby time table. Refer to *Standby on page 28*.

Timer setting Period 1 (A): 00:00-18:00

Timer setting Period 2 (C): 20:00-23:00

Active period (A): 00:00-18:00

Active period (C): 20:00-22:00

The product operates between 00:00 and 18:00. It starts again at 20:00 but stops at 22:00 due to standby mode until it starts again at 00:00.

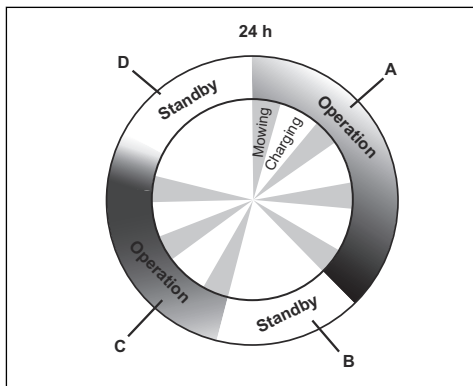

#### Example: A specified work area of 1000 m<sup>2</sup>

|                                      |    |
|--------------------------------------|----|
| Operation, A + C = max. hours        | 20 |
| Charging/Standby, B + D = min. hours | 4  |

### 4.7 To charge the battery

When the product is new or has been stored for a long period, the battery can be empty and needs to be charged before starting. In the *Auto* mode, the product automatically alternates between mowing and charging.



**WARNING:** Only charge the product using a charging station and a power supply which is intended for it.

Incorrect use may result in electric shock, overheating or leakage of corrosive liquid from the battery.

In the event of leakage of electrolyte flush with water and seek medical help if it comes in contact with the eyes etc.

1. Set the **Main switch** to position *1*.
2. Place the product in the charging station.
3. Open the hatch and slide the product in as far as possible to ensure proper contact between the product and the charging station.
4. The display shows a message that charging is in progress.

### 4.8 Adjust the cutting height

The cutting height can be varied from MIN (2 cm / 0.8 in.) to MAX (5 cm / 2 in.).

**Note:** During the first week after a new installation, the cutting height must be set to MAX to avoid damaging the loop wire. After this, the cutting height can be lowered step by step every second week until the desired cutting height has been reached.

#### 4.8.1 To adjust the cutting height

1. Press the **STOP** button to stop the product and open the hatch.
2. Turn the height adjustment knob to the required position. The selected position is indicated by the orange column on the height adjustment indicator.
  - Turn counterclockwise to increase the cutting height.
  - Turn clockwise to lower the cutting height.

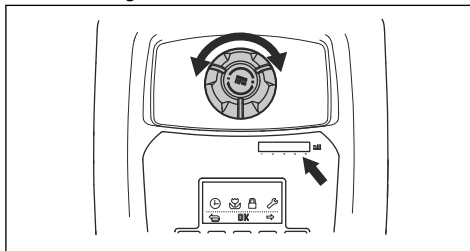

3. Close the hatch.

---

## 5 Maintenance

---

### 5.1 Introduction - maintenance

For better operating reliability and longer service life: check and clean the product regularly and replace worn parts if necessary. All maintenance and servicing must be done according to McCULLOCH's instructions. Refer to *Warranty on page 45*.

When the product is first used, the blade disc and blades should be inspected once a week. If the amount of wear during this period has been low, the inspection interval can be increased.

It is important that the blade disc rotates easily. The edges of the blades should not be damaged. The lifetime of the blades varies immensely and depends for instance on:

- Operating time and size of the work area.
- Type of grass and seasonal growth.
- Soil, sand and use of fertilizers.
- The presence of objects such as cones, windfalls, toys, tools, stones, roots and the like.

The normal life is 4 to 7 weeks when used under favorable conditions. Refer to *To replace the blades on page 31* on how to replace the blades.

**Note:** Working with blunt blades gives a poorer mowing result. The grass is not cut cleanly and more energy is needed resulting in the product not mowing such a large area.



**WARNING:** The product must be switched off before any maintenance is done.

---



**WARNING:** Wear protective gloves.

---

### 5.2 Clean the product

It is important to keep the product clean. A product with large amounts of grass stuck to it will not cope as well with slopes. It is recommended to clean using a brush.

McCULLOCH offers a special cleaning and maintenance kit as an accessory. Contact your McCULLOCH central service.



**CAUTION:** Never use a high-pressure washer or even running water to clean the product. Never use solvents for cleaning.

---

#### 5.2.1 Chassis and blade disc

Inspect the blade disc and blades once a week.

1. Set the **Main switch** to position 0.
2. Lift the product onto its side.
3. Clean the blade disc and chassis using for example a dish brush. At the same time, check that the blade disc rotates freely in relation to the foot guard. Also, check that the blades are intact and can pivot freely.

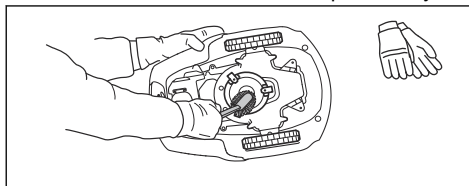

#### 5.2.2 Wheels

Clean around the front wheels and rear wheel as well as the rear wheel bracket. Grass on the wheels can impact on how the product performs in slopes.

#### 5.2.3 Cover

Use a damp, soft sponge or cloth to clean the cover. If the cover is very dirty it may be necessary to use a soap solution or washing-up liquid.

#### 5.2.4 Charging station

Clean the charging station regularly from grass, leaves, twigs and other objects that may impede docking.



**WARNING:** Use the plug to disconnect the charging station before any maintenance, or cleaning of charging station or power supply.

---

## 5.3 Replace the blades



**WARNING:** Use blades and screws of the right type. McCULLOCH can only guarantee safety when using original blades. Only replacing the blades and reusing the screw can result in a screw wearing during mowing. The blades can then be propelled from under the body and cause serious injury.

Replace worn or damaged parts for safety reasons. Even if the blades are intact, they should be replaced on a regular basis for the best mowing result and low energy usage. All 3 blades and screws must be replaced at the same time to obtain a balanced cutting system. Use McCULLOCH original blades embossed with the crowned H-mark logotype, refer to *Warranty terms on page 45*.

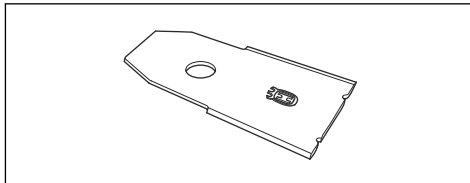

### 5.3.1 To replace the blades

1. Set the main switch to position 0.

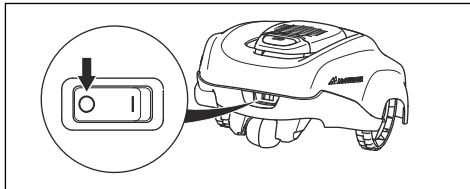

2. Turn the product upside down. Place the product on a soft and clean surface to avoid scratching the body and the hatch.
3. Remove the 3 screws. Use a straight slot or cross-tip screwdriver.

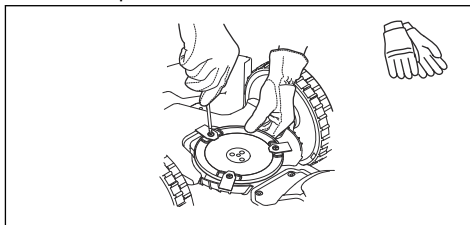

4. Remove each blade and screw.
5. Fasten new blades and screws.
6. Check that the blades can pivot freely.

## 5.4 Firmware update

If service is done by McCULLOCH customer service then available firmware updates are downloaded to the product by the service technician.

## 5.5 Battery



**WARNING:** Only charge the product using a charging station which is intended for it. Incorrect use may result in electric shock, overheating or leakage of corrosive liquid from the battery. In the event of leakage of electrolyte flush with water and seek medical help if it comes in contact with the eyes etc.



**WARNING:** Use only original batteries recommended by the manufacturer. Product safety cannot be guaranteed with other batteries. Do not use non-rechargeable batteries.



**CAUTION:** The battery must be charged fully before winter storage. If the battery is not fully charged it can be damaged and in certain cases be rendered useless.

If the operating times for the product are shorter than normal between charges, this indicates that the battery is getting old and eventually needs replacing.

**Note:** Battery life is dependent on the length of the season and how many hours a day the product is operating. A long season or many hours of use a day means that the battery must be replaced more regularly. The battery is fine as long as the product maintains a well-cut lawn.

### 5.5.1 To replace the battery



**WARNING:** Use only original batteries recommended by the manufacturer. Product safety cannot be guaranteed with other than original batteries. Do not use non-rechargeable batteries.

1. Set the **main switch** in position *0*.
2. Set the cutting height to its lowest position.
3. Turn the product upside down. Place the product on a soft and clean surface to avoid scratching the body and the display cover.
4. Clean around the battery cover.
5. Remove the 4 screws (Torx 20) on the battery cover and remove the battery cover.

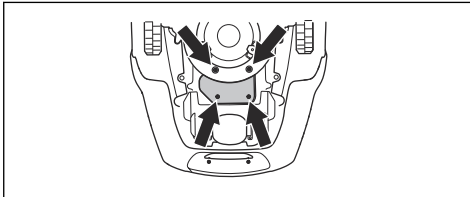

6. Remove the screw on the battery retaining bracket and remove the bracket.
7. Pull out the battery by pulling on the strap.
8. Attach a new original battery.



**CAUTION:** Do not press on the battery pack. Press on the contact strip to attach the battery in position.

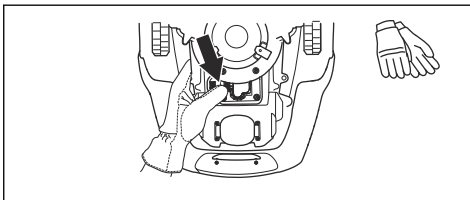

9. Attach the battery retaining bracket into position with a screw.
10. Attach the battery cover without clamping the cables.



**CAUTION:** If the seal on the battery cover is damaged, the

entire battery cover must be replaced.

11. Attach the battery cover with 4 screws (Torx 20).
12. Reset the cutting height to the required level.

### 5.6 Winter service

Take your product to your McCULLOCH central service for service prior to winter storage.

Regular winter service will maintain the product in good condition and create the best conditions for a new season without any disruptions.

Service usually includes the following:

- Thorough cleaning of the body, the chassis, the blade disc and all other moving parts.
- Testing of the product's function and components.
- Checking and, if required, replacing wear items such as blades and bearings.
- Testing the product's battery capacity as well as a recommendation to replace battery if necessary.
- If new firmware is available, the product is updated.



## 6 Troubleshooting

### 6.1 Introduction - troubleshooting

In this chapter, a number of messages are listed which may be shown in the display if there is a malfunction. There is a proposal as to the cause and steps to take for each message. This chapter also presents some symptoms that can guide you if the product does not work as expected. More suggestions for steps to take in the event of malfunction or symptoms can be found on [www.mcculloch.com](http://www.mcculloch.com).

### 6.2 Messages

Below a number of messages are listed which may be shown in the display of the product. Contact your local McCULLOCH representative if the same message appears often.

| Message                                | Cause   | Action   |
|--|---|--|
| <i>Wheel motor blocked, left/right</i> | Grass or other object is wrapped around the drive wheel.  | Check the drive wheel and remove the grass or other object.  |
| <i>Cutting system blocked</i>          | Grass or other object is wrapped around the blade disc.   | Check the drive wheel and remove the grass or other object.  |
|  | The blade disc lies in a pool of water.   | Move the product and prevent the collection of water in the work area.   |
| <i>Trapped</i>                         | The product has got caught in something.  | Free the product and rectify the reason for it becoming trapped.   |
|  | The product is stuck behind a number of obstacles.  | Check if there are any obstacles which make it hard for the product to move on from this location.                                 |
| <i>Outside working area</i>            | The boundary wire connections to the charging station are crossed.                              | Check that the boundary wire is connected correctly.   |
|  | The boundary wire is too close to the edge of the work area.                                    | Check that the boundary wire has been laid according to the instructions in <i>To install the boundary wire on page 20</i> .       |
|  | The work area slopes too much.  |  |
|  | The boundary wire is laid in the wrong direction around an island.                              |  |
|  | Disturbances from metal objects (fences, reinforcement steel) or buried cables close by.        | Try moving the boundary wire.  |
|  | The product finds it hard to distinguish the signal from another product installation close by. | Place the product in the charging station and generate a new loop signal. Refer to <i>To create a New loop signal on page 24</i> . |

| <b>Message</b>                            | <b>Cause</b>  | <b>Action</b>   |
|---|---|---|
| <i>Low battery / Empty battery</i>        | The product cannot find the charging station.   | Check that the charging station and the guide wire are installed in accordance with the instructions in <i>Installation of the product on page 19</i> . |
|   | The guide wire is broken or not connected.  | Check that the indicator lamp in the charging station flashes yellow. Refer to <i>Indicator lamp in the charging station on page 37</i> .               |
|   | The battery is spent.   | Replace the battery. Refer to <i>To replace the battery on page 32</i> .  |
|   | The charging station's antenna is defective.  | Check if the indicator lamp in the charging station flashes red. Refer to <i>Indicator lamp in the charging station on page 37</i> .                    |
| <i>Wrong PIN</i>                          | Wrong PIN code has been entered. Five attempts are permitted, and the keypad is then blocked for five minutes.                  | Enter the correct PIN code. Contact your local McCULLOCH representative if you forget the PIN code.   |
| <i>Wheel motor overloaded, right/left</i> | The product has got caught in something.  | Free the product and rectify the reason for the lack of drive. If it is due to wet grass, wait until the lawn has dried before using the product.       |
| <i>No drive</i>                           | The product has got caught in something.  | Free the product and rectify the reason for the lack of drive. If it is due to wet grass, wait until the lawn has dried before using the product.       |
|   | The work area includes a steep slope.   | Maximum guaranteed slope is 25%. Steeper slopes should be isolated. Refer to <i>To put the boundary wire in a slope on page 17</i> .                    |
|   | The guide wire is not laid at an angle on a slope.  | If the guide wire is laid on a slope, it must be laid at an angle across the slope. Refer to <i>To examine where to put the guide wire on page 18</i>   |
| <i>Charging station blocked</i>           | The contact between the charging strips and contact strips may be poor and the product has made a number of attempts to charge. | Put the product in the charging station and check that the charging strips and contact strips make good contact.  |
|   | An object is obstructing the product.   | Remove the object.  |
|   | The charging station is tilted or bent.   | Confirm that the charging station is placed on a fully flat and horizontal ground. The charging station must not be tilted or bent.                     |

| <b>Message</b>                              | <b>Cause</b>   | <b>Action</b>   |
|---|--|---|
| <i>Stuck in charging station</i>            | There is an object in the way of the product preventing it from leaving the charging station.                  | Remove the object.  |
| <i>Upside down</i>                          | The product is leaning too much or has turned over.  | Turn the product the right way up.  |
| <i>Needs manual charging</i>                | The product is set in the <i>MAN</i> operating mode.   | Place the product in the charging station. This behavior is normal and no action is required.     |
| <i>Next start hh:mm</i>                     | The timer setting prevents the product from operating.   | Change the timer settings. Refer to <i>To do the timer settings on page 22</i> .                  |
|   | The rest period is in progress. The product has an inbuilt standby period according to the Standby time table. | This behavior is normal and no action is required. Refer to <i>Timer and Standby on page 28</i> . |
| <i>The day's mowing is complete</i>         | The rest period is in progress. The product has an inbuilt standby period according to the Standby time table. | This behavior is normal and no action is required. Refer to <i>Standby on page 28</i> .           |
| <i>Lifted</i>                               | The lift sensor has been activated as the product has become trapped.  | Free the product.   |
| <i>Collision sensor problem, front/rear</i> | Product body can not move freely around its chassis.   | Check that the product body can move freely around its chassis.                                   |
| <i>Wheel drive problem, right/left</i>      | Grass or other object is wrapped around the drive wheel.   | Clean the wheels and around the wheels.   |
| <i>Alarm! Mower switched off</i>            | The alarm was activated because the product was switched OFF.  | Adjust the product security level in the Security menu.   |
| <i>Alarm! Mower stopped</i>                 | The alarm was activated because the product was stopped.   |   |
| <i>Alarm! Mower lifted</i>                  | The alarm was activated because the product was lifted.  |   |
| <i>Alarm! Mower tilted</i>                  | The alarm was activated because the product was tilted.  |   |
| <i>Temporary battery problem</i>            | Temporary battery or firmware related issue in the product.  | Restart the product. Disconnect and reconnect the battery.  |
| <i>Charging current too high</i>            | Wrong or faulty power supply unit.   | The message may require action by authorized service technician.                                  |

| <b>Message</b>        | <b>Cause</b>   | <b>Action</b>   |
|-----------------------|--|---|
| <i>No loop signal</i> | The power supply is not connected.   | Check the wall socket connection and whether an earth-fault breaker has tripped or not.   |
|                       | The boundary wire is not connected to the charging station                               | Check that the boundary wire connector is fitted properly to the charging station. Replace connectors if damaged. Refer to <i>To install the boundary wire on page 20</i> .               |
|                       | Boundary wire broken.  | Find out where the break is. Replace the damaged section of the loop with a new loop wire and splice using an original coupler. Refer to <i>Find breaks in the loop wire on page 39</i> . |
|                       | The boundary wire is crossed on its way to and from an island.                           | Check that the boundary wire is laid according to instructions, e.g. in the right direction around the island. Refer to <i>To install the boundary wire on page 20</i> .                  |
|                       | The connection between the product and the charging station has been broken.             | Place the product in the charging station and generate a new loop signal. Refer to <i>To create a New loop signal on page 24</i> .  |
|                       | Disturbances from metal objects (fences, reinforcement steel) or buried cables close by. | Try moving the boundary wire.   |

### 6.3 Indicator lamp in the charging station

For a fully functional installation, the indicator lamp in the charging station must emit a solid green light. If something else appears, follow the troubleshooting guide below.

If you still need help with troubleshooting, please contact your local McCULLOCH representative.

| Light                        | Cause  | Action   |
|------------------------------|--|--|
| <i>Solid green light</i>     | Everything in order  | No action required   |
| <i>Green flashing light</i>  | The signals are good and <i>ECO mode</i> is activated.   | No action required. For more information on <i>ECO mode</i> , Refer to <i>ECO mode on page 25</i> .  |
| <i>Blue flashing light</i>   | The boundary loop is not connected to the charging station   | Check that the boundary wire connector is fitted properly to the charging station. Refer to <i>To install the guide wire on page 20</i> .  |
|                              | Break in the boundary loop   | Find out where the break is. Replace the damaged section of the boundary wire with a new loop wire and splice using an original coupler. Refer to <i>Find breaks in the loop wire on page 39</i> . |
| <i>Yellow flashing light</i> | The guide wire is not connected to the charging station  | Check that the guide wire connector is properly connected to the charging station. Refer to <i>To install the guide wire on page 20</i>  |
|                              | Break in the guide wire  | Find out where the break is. Replace the damaged section of the guide wire with a new loop wire and splice using an original coupler.  |
| <i>Red flashing light</i>    | Interruption in the charging station's antenna   | Contact your local McCULLOCH representative.   |
| <i>Solid red light</i>       | Fault in the circuit board or incorrect power supply in the charging station. The fault should be rectified by an authorized service technician. | Contact your local McCULLOCH representative.   |

## 6.4 Symptoms

If your product does not work as expected, follow the troubleshooting guide below.

There is a FAQ (Frequently Asked Questions) on [www.mcculloch.com](http://www.mcculloch.com) which provides more detailed answers to a number of standard questions. Contact your local McCULLOCH representative if you still cannot find the reason for the fault.

| Symptoms  | Cause  | Action   |
|---|--|--|
| Uneven mowing results.                                | The product works too few hours per day.   | Increase the mowing time. Refer to <i>To calculate the timer setting on page 22</i> .  |
|   | The <i>Proportion</i> setting is incorrect in relation to the layout of the work area.   | Check that the correct <i>Proportion</i> value is selected.  |
|   | The shape of the work area requires the use of the <i>Remote start</i> function for the product to find its way to all remote areas. | Steer the product to a remote area. Refer to <i>Remote start 2 on page 23</i> .  |
|   | Work area too large.   | Try limiting the work area or extending the work time. Refer to <i>Timer and Standby on page 28</i> .  |
|   | Dull blades.   | Replace all the blades and screws so that the rotating parts are balanced. Refer to <i>Replace the blades on page 31</i> .   |
|   | Long grass in relation to the set cutting height.  | Increase the cutting height and then successively lower.   |
|   | Accumulation of grass by the blade disc or around the motor shaft.   | Check that the blade disc rotates freely and easily. If not, screw off the blade disc and remove grass and foreign objects. Refer to <i>Clean the product on page 30</i> . |
| The product runs at the wrong time                    | The product clock needs to be set.   | Set the clock. Refer to <i>To set the Time &amp; Date on page 25</i> .   |
|   | The start and stop times for mowing are incorrect.   | Reset the start time and stop time settings for mowing. Refer to <i>To set the Time &amp; Date on page 25</i> .  |
| The product vibrates.                                 | Damaged blades lead to imbalance in the cutting system.  | Inspect the blades and screws and replace them if necessary. Refer to <i>To replace the blades on page 31</i> .  |
|   | Many blades in the same position lead to imbalance in the cutting system.  | Check that only one blade is fitted at each screw.   |
| The product runs, but the blade disc does not rotate. | The product searches for the charging station.   | No action. The blade disc does not rotate when the product is searching for the charging station.  |

| Symptoms   | Cause   | Action   |
|--|---|--|
| The product mows for shorter periods than usual between charges. | Grass or other foreign object blocks the blade disc.  | Remove and clean the blade disc. Refer to <i>Clean the product on page 30</i> .  |
| Both the mowing and charging times are shorter than usual.       | The battery is spent.   | Replace the battery. Refer to <i>To replace the battery on page 32</i> .   |
| The product is parked for hours in the charging station.         | The product has an inbuilt standby period according to the Standby time table. Refer to <i>Standby on page 28</i> . | No action.   |
|  | The hatch has been closed without the <b>START</b> button first being pressed.                                      | Open the hatch, press the <b>START</b> button and then close the hatch.  |
| The product has difficulty docking.                              | The boundary wire is not laid in a long straight line that is far enough out from the charging station.             | Check that the charging station has been installed according to the instructions in <i>To install the charging station on page 19</i>  |
|  | The guide wire is not inserted in the slot at the bottom of the charging station.                                   | It is absolutely critical for operation that the guide wire is perfectly straight and is in the correct position under the charging station. Therefore make sure that the guide wire is always in its slot in the charging station. Refer to <i>To install the charging station on page 19</i> . |
|  | The charging station is on a slope.   | Place the charging station on a surface that is entirely level. Refer to <i>To examine where to put the charging station on page 15</i> .  |

## 6.5 Find breaks in the loop wire

Breaks in the loop wire are usually the result of unintentional physical damage to the wire such as when gardening with a shovel. In countries with ground frost, also sharp stones that move in the ground can damage the wire. Breaks can also occur due to the wire being stretched excessively during installation.

Mowing the grass too low right after the installation can damage wire insulation. Damage to the insulation may not cause disruptions until several weeks or months later. To avoid this, always select the maximum cutting height the first weeks after installation and then lower the height one step at a time every second week until the desired cutting height has been reached.

A defective splicing of the loop wire can also lead to disruptions several weeks after the splice was done. A faulty splice can, for example, be the result of the original coupler not being pressed together hard enough with a pair of pliers, or that a coupler of lower quality than the original coupler has been used. Please first check all known splices before further troubleshooting is done.

A wire break can be located by gradually halving the distance of the loop where the break may have occurred until there is only a very short section of the wire left.

The following method does not work if *ECO mode* is activated. Make sure first that *ECO mode* is turned off. Refer to *ECO mode on page 25*.

1. Check that the indicator lamp in the charging station flashes blue, which indicates a break in the boundary loop. Refer to *Indicator lamp in the charging station on page 37*.

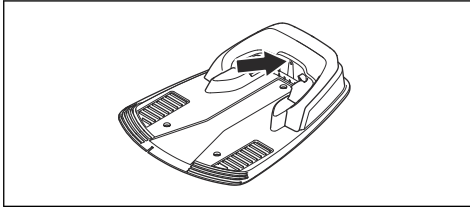

2. Check that the boundary wire connections to the charging station are properly connected and not damaged. Check that the indicator lamp in the charging station is still flashing blue.

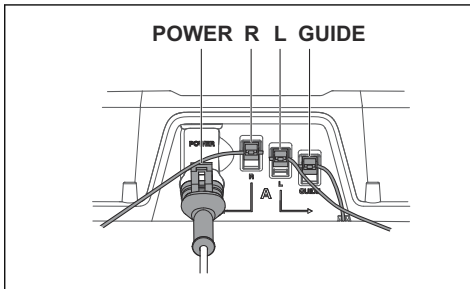

3. Switch the connections between the guide wire and the boundary wire in the charging station.

Start by switching connection L and Guide.

If the indicator lamp is lit with a solid green light, then the break is somewhere on the boundary wire between L and the point where the guide wire is connected to the boundary wire (thick black line in the illustration).

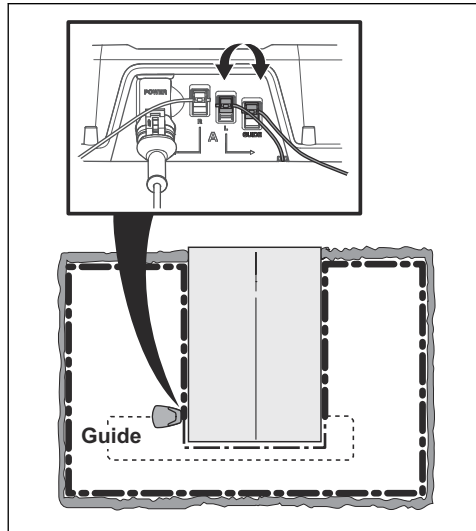

To rectify the fault you will need boundary wire, connector(s) and coupler(s):

a) If the suspected boundary wire is short then it is easiest to exchange all of the boundary wire between L and the point where the guide wire is connected to the boundary wire (thick black line).

b) If the suspected boundary wire is long (thick black line) then do as follows: Put L and Guide back to their original positions. Then disconnect R. Connect a new loop wire to R. Connect the other end of this new loop wire at the middle of the suspected wire section.



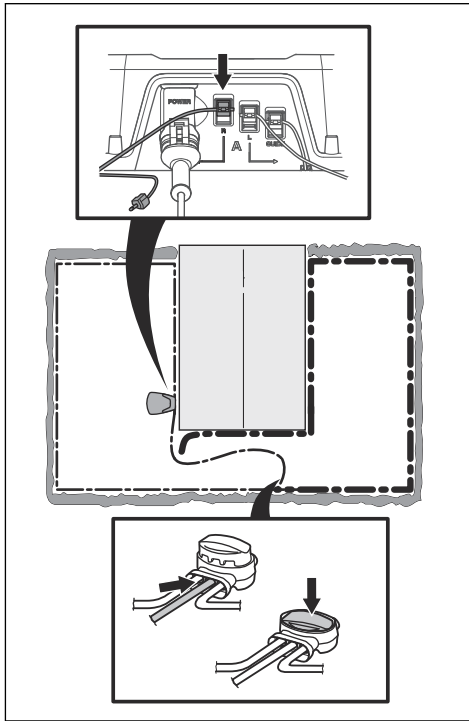

If the indicator lamp now is green, then the break is somewhere in the wire between the disconnected end to the point where the new wire is connected (thick black line below). In that case, move the connection for the new wire closer to the disconnected end (roughly at the middle of the suspected wire section) and check again if the indicator lamp is green.

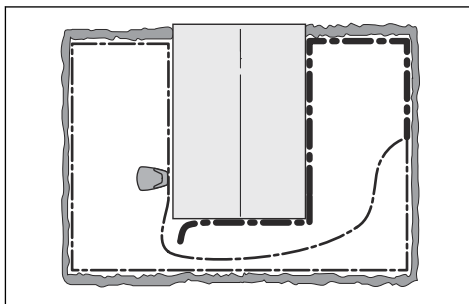

Continue until only a very short section of the wire remains which is the difference

between a solid green light and a flashing blue light. Then follow instruction in step 5 below.

4. If indicator lamp still flashes blue in step 3 above: Put L and Guide back in their original positions. Then switch R and Guide. If indicator lamp now is lit with a solid green light then disconnect L and connect a new boundary wire to L. Connect the other end of this new wire at the middle of the suspected wire section. Follow the same approach as in 3a) and 3b) above.
5. When the break is found, the damaged section must be replaced with a new wire. Always use original couplers.

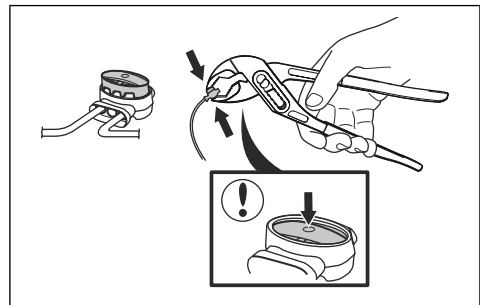

---

## 7 Transportation, storage and disposal

---

### 7.1 Transportation

The supplied Li-ion batteries obey the Dangerous Goods Legislation requirements.

- Obey all applicable national regulations.
- Obey the special requirement on package and labels for commercial transportations, including by third parties and forwarding agents.

### 7.2 Storage

- Fully charge the product. Refer to *To charge the battery on page 29*.
- Switch off the product. Refer to *To switch off the product on page 28*.
- Clean the product. Refer to *Clean the product on page 30*.
- Keep the product in a dry, frost free space.
- Keep the product with all wheels on level ground during storage, or use an original wall hanger if available.
- If you keep the charging station indoors, disconnect and remove the power supply and all the connectors from the charging station. Put the end of each connector wire in a container with grease.

---

**Note:** If you keep the charging station outdoors, do not disconnect the power supply and the connectors.

---

### 7.3 Disposal

- Obey the local recycling requirements and applicable regulations.
- For questions about how to remove the battery, refer to *To replace the battery on page 32*.

## 8 Technical data

### 8.1 Technical data

| Dimensions       | ROB R600  | ROB R800  | ROB R1000 |
|------------------|-----------|-----------|-----------|
| Length, cm / in. | 60 / 23.6 | 60 / 23.6 | 60 / 23.6 |
| Width, cm / in.  | 44 / 17.3 | 44 / 17.3 | 44 / 17.3 |
| Height, cm / in. | 26 / 10.2 | 26 / 10.2 | 26 / 10.2 |
| Weight, kg / lbs | 7 / 15.4  | 7 / 15.4  | 7 / 15.4  |

| Electrical system                           | ROB R600   | ROB R800   | ROB R1000  |
|---|--|--|--|
| Battery, Lithium-Ion 18 V/2.1 Ah Art. No    | 586 57 62-02   |  |  |
| Battery, Lithium-Ion 18 V/2.0 Ah Art. No    | 586 57 62-03   |  |  |
| Battery, Lithium-Ion 18.25 V/2.0 Ah Art. No | 586 57 62-04   |  |  |
| Power supply, V/28 V DC                     | 100-240  |  |  |
| Low voltage cable length, m / ft            | 5 / 16   | 5 / 16   | 5 / 16   |
| Mean energy consumption at maximum use      | 5 kWh/month<br>for a work area<br>of 600 m <sup>2</sup> / 718<br>yd <sup>2</sup> | 6 kWh/month<br>for a work area<br>of 800 m <sup>2</sup> / 957<br>yd <sup>2</sup> | 7 kWh/month<br>for a work area<br>of 1000 m <sup>2</sup> /<br>1196 yd <sup>2</sup> |
| Charge current, A DC                        | 1.3  | 1.3  | 1.3  |
| Average mowing time, min                    | 65   | 65   | 65   |
| Average charging time, min                  | 50   | 50   | 50   |

| Boundary wire antenna                               | ROB R600  | ROB R800  | ROB R1000 |
|---|-----------|-----------|-----------|
| Operating Frequency Band, Hz                        | 300-80000 | 300-80000 | 300-80000 |
| Maximum Radio-frequency power, mW @60m <sup>1</sup> | <25       | <25       | <25       |

<sup>1</sup> Maximum output power to antennas in the frequency band in which the radio equipment operates.

| Noise emissions measured in the environment as sound power <sup>2</sup> | ROB R600 | ROB R800 | ROB R1000 |
|---|----------|----------|-----------|
| Measured sound power noise level, dB (A)                                | 57       | 57       | 57        |
| Guaranteed sound power noise level <sub>WA</sub> , dB (A)               | 59       | 59       | 59        |
| Sound pressure noise level at the operator's ear, dB (A) <sup>3</sup>   | 48       | 48       | 48        |

| Mowing   | ROB R600                 | ROB R800    | ROB R1000   |
|--|--------------------------|-------------|-------------|
| Cutting system   | 3 pivoted cutting blades |             |             |
| Blade motor speed, rpm                                       | 2900                     | 2900        | 2900        |
| Power consumption during cutting, W +/- 20 %                 | 20                       | 20          | 20          |
| Cutting height, cm / in.                                     | 2-5 / 0.8-2              | 2-5 / 0.8-2 | 2-5 / 0.8-2 |
| Cutting width, cm / in.                                      | 17 / 6.7                 | 17 / 6.7    | 17 / 6.7    |
| Narrowest possible passage, cm / in.                         | 120 / 47                 | 120 / 47    | 120 / 47    |
| Maximum angle for work area, %                               | 25                       | 25          | 25          |
| Maximum angle for boundary wire, %                           | 15                       | 15          | 15          |
| Maximum length boundary wire, m / ft.                        | 400 / 1312               | 400 / 1312  | 400 / 1312  |
| Maximum length guide loop, m / ft.                           | 100 / 328                | 100 / 328   | 100 / 328   |
| Working capacity, m <sup>2</sup> / yd <sup>2</sup> , +/- 20% | 600 / 718                | 800 / 957   | 1000 / 1196 |

| IP-classification  | ROB R600 | ROB R800 | ROB R1000 |
|--------------------|----------|----------|-----------|
| Robotic lawn mower | IPX4     | IPX4     | IPX4      |
| Charging station   | IPX1     | IPX1     | IPX1      |
| Transformer        | IPX4     | IPX4     | IPX4      |

Full compatibility cannot be guaranteed between the product and other types of wireless systems such as remote controls, radio transmitters, hearing loops, buried electric animal fencing or similar.

The products are made in England or the Czech Republic. See information on the rating plate. Refer to *Introduction on page 3*.

<sup>2</sup> Noise emissions in the environment measured as sound power ( $L_{WA}$ ) in conformity with EC directive 2000/14/EC and New South Wales legislation (Protection of the Environment Operations Regulation 2017, Noise Control). The guaranteed sound power level includes variation in production as well as variation from the test code with 1-3 dB(A). Noise emission data can be found on the rating label and in the Technical data chapter.

<sup>3</sup> Sound pressure noise uncertainties  $K_{pA}$ , 2-4 dB (A)

---

## 9 Warranty

---

### 9.1 Warranty terms

McCULLOCH warranty covers this product's functionality for a period of 2 years from date of purchase. The warranty covers serious faults relating to materials or manufacturing faults.

Within the warranty period, we will replace the product or repair it at no charge if the following terms are met:

- The product and the charging station may only be used in compliance with the instructions in this Operator's Manual. This manufacturer's warranty does not affect warranty entitlements against the dealer/retailer.
- End-users or non-authorized third parties must not attempt to repair the product.

Examples of faults which are not included in the warranty:

- Damage caused by water seepage from using a high-pressure washer, or from being submerged under water, for example when heavy rain forms pools of water.
- Damage caused by lightning.
- Damage caused by improper battery storage or battery handling.
- Damage caused by using a battery that is not a McCULLOCH original battery.
- Damage caused by not using McCULLOCH original spare parts and accessories, such as blades and installation material.
- Damage to the loop wire.
- Damage caused by non-authorized changing or tampering with the product or its power supply.

The blades and wheels are seen as disposable and are not covered by the warranty.

If an error occurs with your McCULLOCH product, please contact McCULLOCH customer service for further instructions. Please have the receipt and the products's serial number at hand when contacting McCULLOCH customer service.

---

## 10 Applicable to US/CA market

---

### 10.1 Supplier's Declaration of Conformity

Issuer: Husqvarna AB, Drottninggatan 2, S-561  
82 Huskvarna, Sweden  
[www.husqvarnagroup.com](http://www.husqvarnagroup.com).

Responsible party: Husqvarna Professional  
Products, Inc. 9335 Harris Corners Parkway  
Suite 500 Charlotte, NC 28269 United States  
U.S. Contact information: James McNew,  
Manager Product Compliance, Telephone: +1  
704 597 5000.





Copyright © 2019 Husqvarna AB. All rights reserved.

McCulloch and other product and feature names are trademarks of the Husqvarna Group.  
All measurements quoted are approximate.

[www.mcculloch.com](http://www.mcculloch.com)

---

Original instructions

1140730-95



2019-08-19